

MIT OpenCourseWare
<http://ocw.mit.edu>

16.89J / ESD.352J Space Systems Engineering
Spring 2007

For information about citing these materials or our Terms of Use, visit: <http://ocw.mit.edu/terms>.

MINERVA

Critical Design Review

Mission Statement

**Establish an enabling space infrastructure
that will support the exploration of Mars.**

16.89

May 8, 2000

Department of Aeronautics and Astronautics
Massachusetts Institute of Technology

Agenda

- ◆ Introduction
- ◆ General mission overview
- ◆ Detailed design
- ◆ System level issues
- ◆ Lessons learned and conclusions



Introduction



Motivation for Mission

- ◆ **Dramatically enhance the value of future Mars missions**
- ◆ Infrastructure at Mars provides major increase in science return
 - Pathfinder: 30 MB/sol → **MINERVA: 10 GB/sol**
 - Support for up to 10 Mars Surface Elements (MSEs)
 - Accurate location information
- ◆ Robotic mission designers can focus on science mission
- ◆ Enhanced probability of mission success
- ◆ **More science for the taxpayer's dollar!**

User Needs

- ◆ MINERVA system shall provide enabling infrastructure to support exploration of Mars.
- ◆ The infrastructure shall provide Mars Surface Elements (MSEs) with:
 - ◆ Communication services between Mars surface and Earth Ground Stations (EGS)
 - ◆ Their position on the surface of Mars, without imposing additional design constraints on MSEs.

Requirements Flow Down

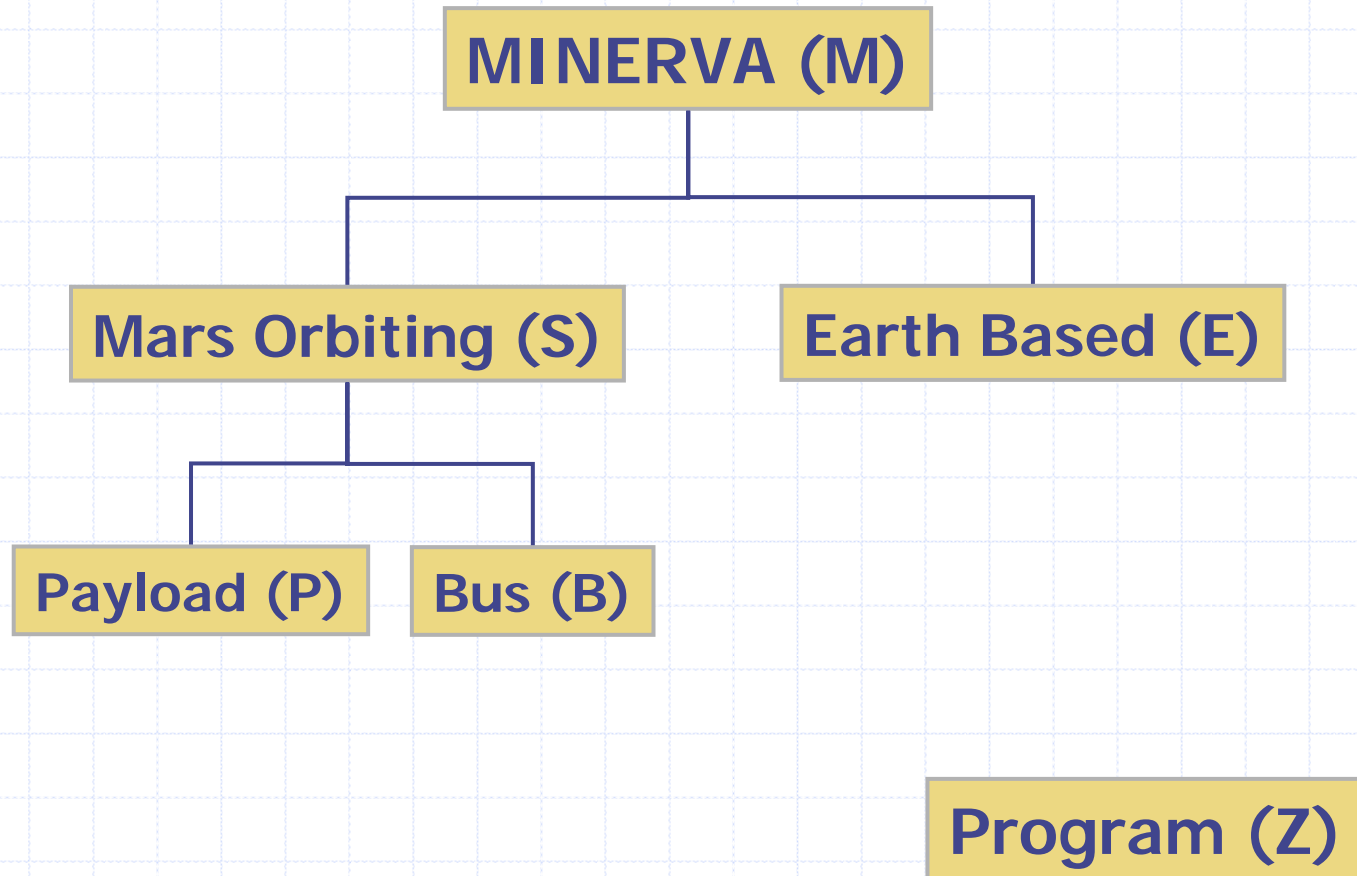



General Mission Overview



Design Summary

- ◆ Mars-orbiting constellation
 - Number of spacecraft: 4
 - Number of orbit planes: 2
 - Altitude: 2000 km
 - Inclination: 27°
- ◆ Spacecraft wet mass: 470 kg
- ◆ System cost: \$297.9 M
 - Drivers: software development, launch

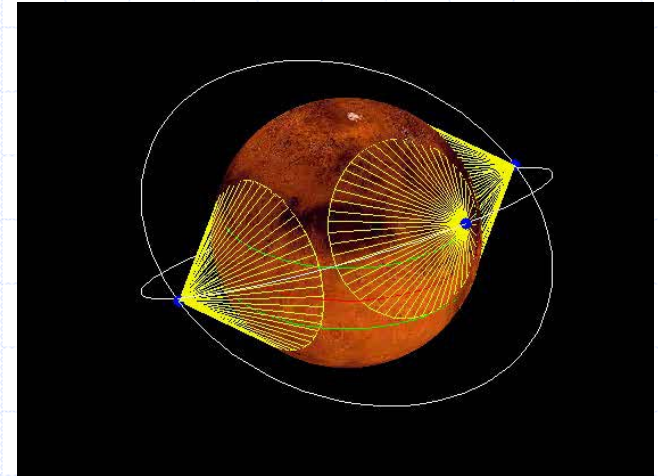

Launch

Launch date	18 Aug 2007
Launch window	± 1 sec, every 1 sidereal day from 3–18 Aug 2007
Launch site	Cape Canaveral Air Station
Launch vehicle	Delta III
Vehicle provider	Boeing
Total mass	1974 kg
Shared payload	Possible, but not necessary
Configuration	Four stacked spacecraft

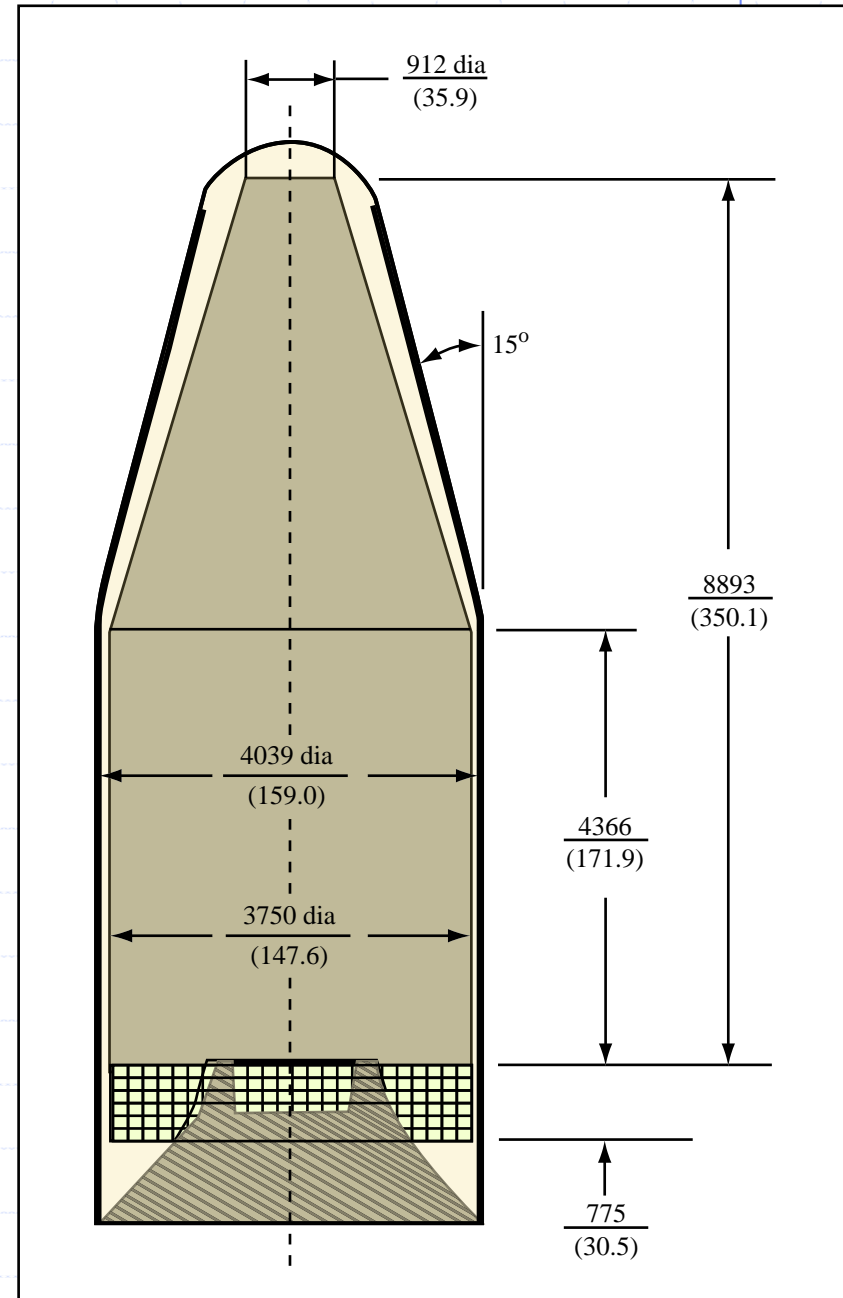

Transit Overview

Launch	18 Aug 2007
Departure burn	T+ 0d 3:23
Separation	T+ 0d 3:29
Deploy arrays	T+ 0d 6:01
Initial checkout	T+ 0d 6:05
Alignment burn	T+ 2d 16:39
Correction burn	T+ 122d 16:00
Insertion burn	T+ 285d 14:29
Circularization	T+ 290d 8:22
Deploy antenna	T+ 290d 8:24
Test/calibration	T+ 296d 12:00
IOC	10 Jul 2008

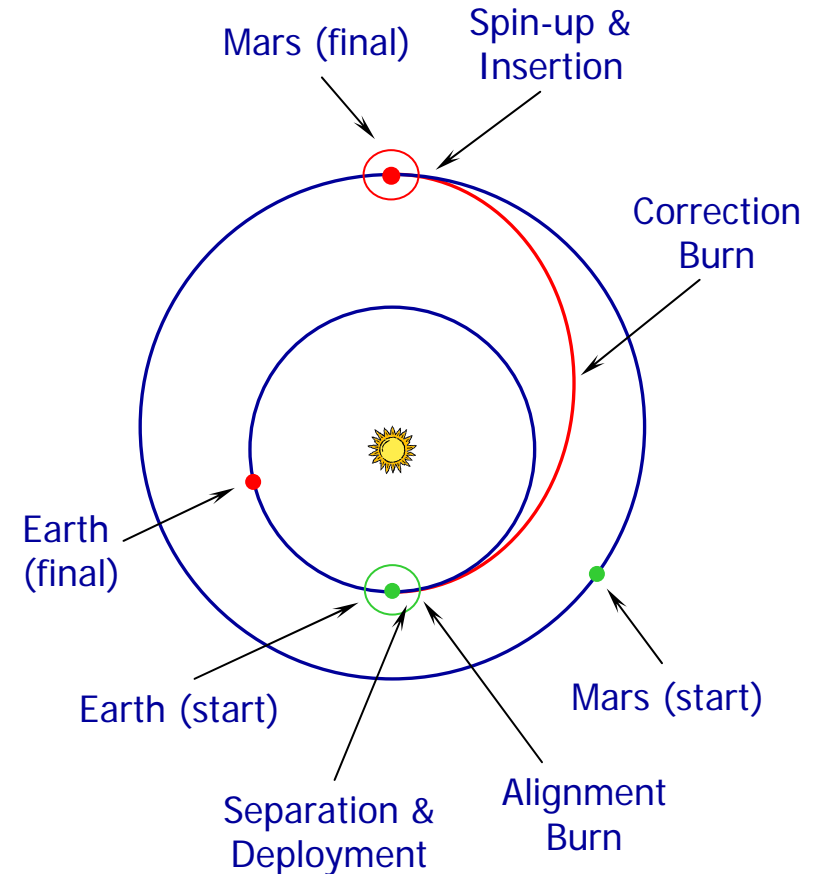

Day in the Life: Positioning

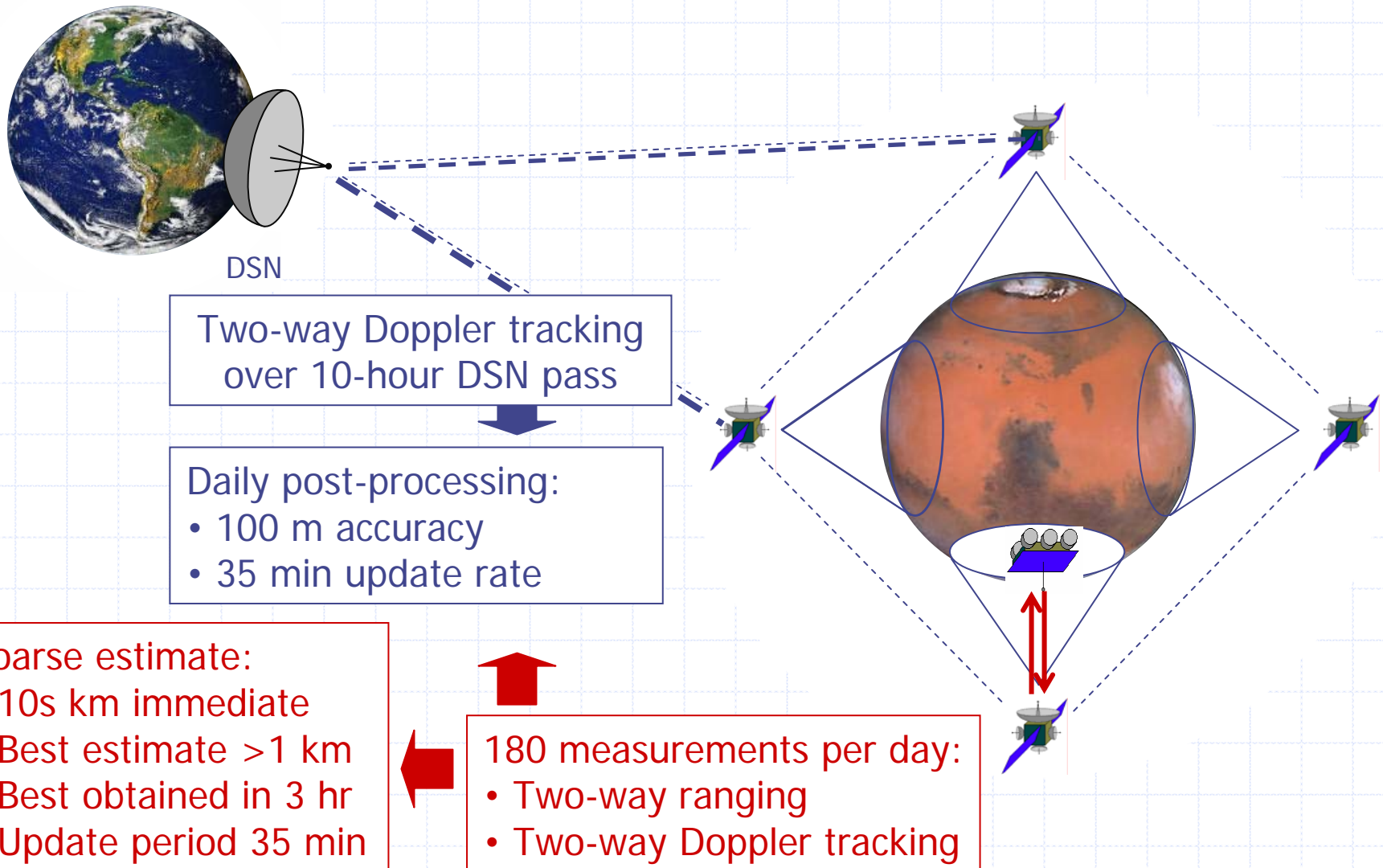

Day in the Life: Communication

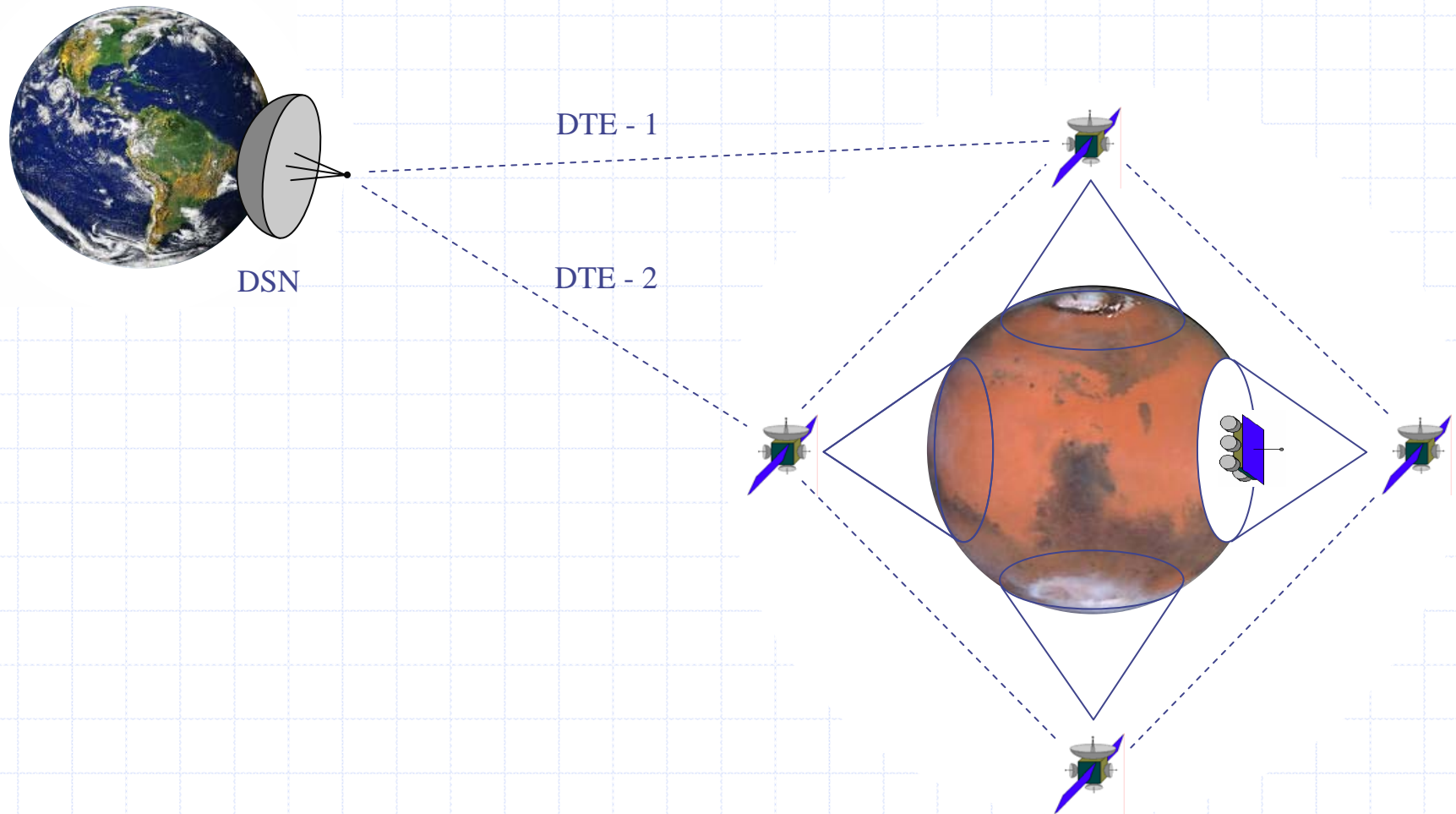

Day in the Life: Communication

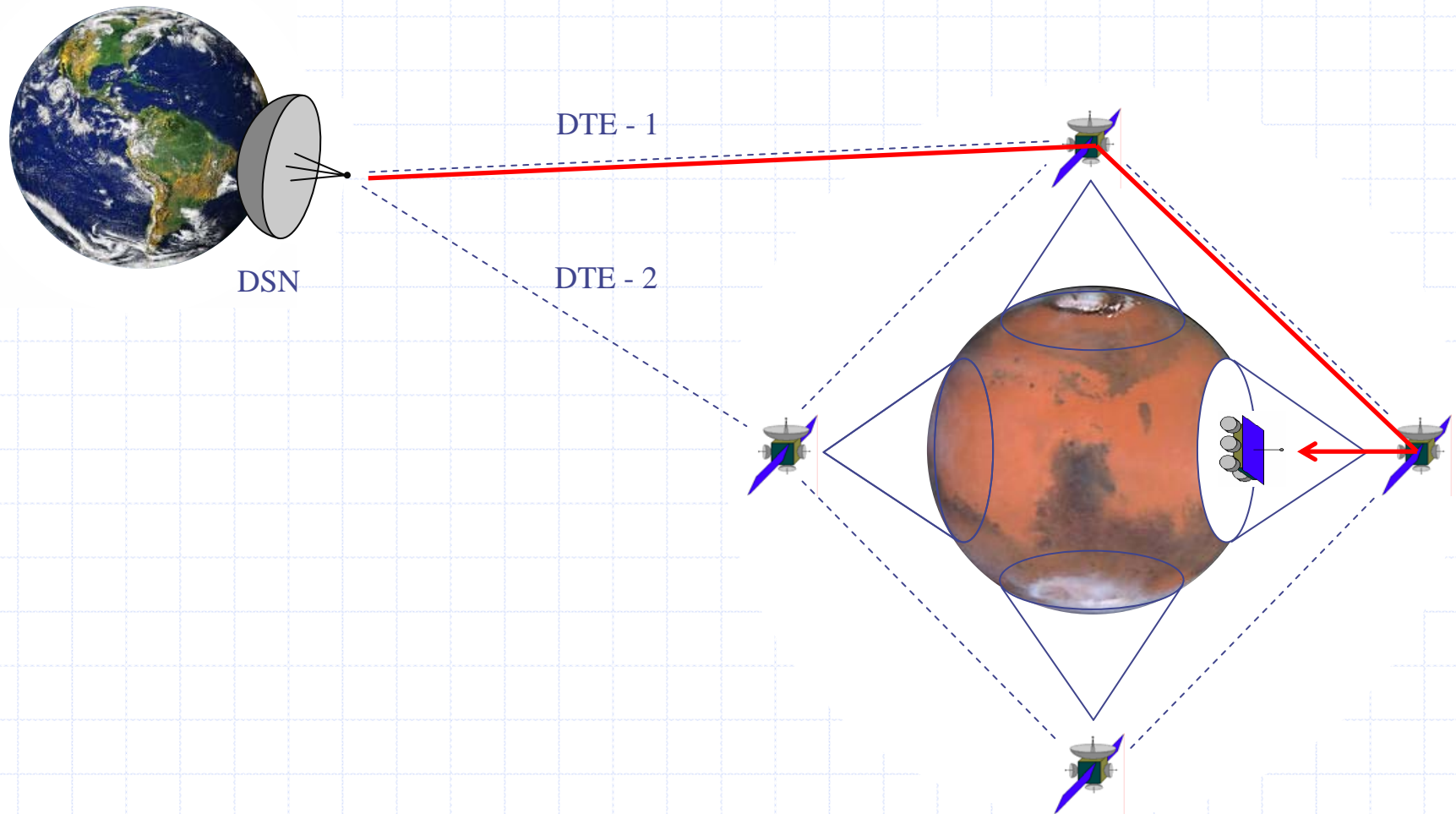

End of Life: Disposal

- ◆ Satellite has capability to insert into a disposal orbit
 - Boost to 2150 km altitude
 - Requires only 40 m/s ΔV
- ◆ Allows constellation replenishment



Detailed Design



Design Iteration Process

◆ Integrated Concurrent Engineering (ICE)

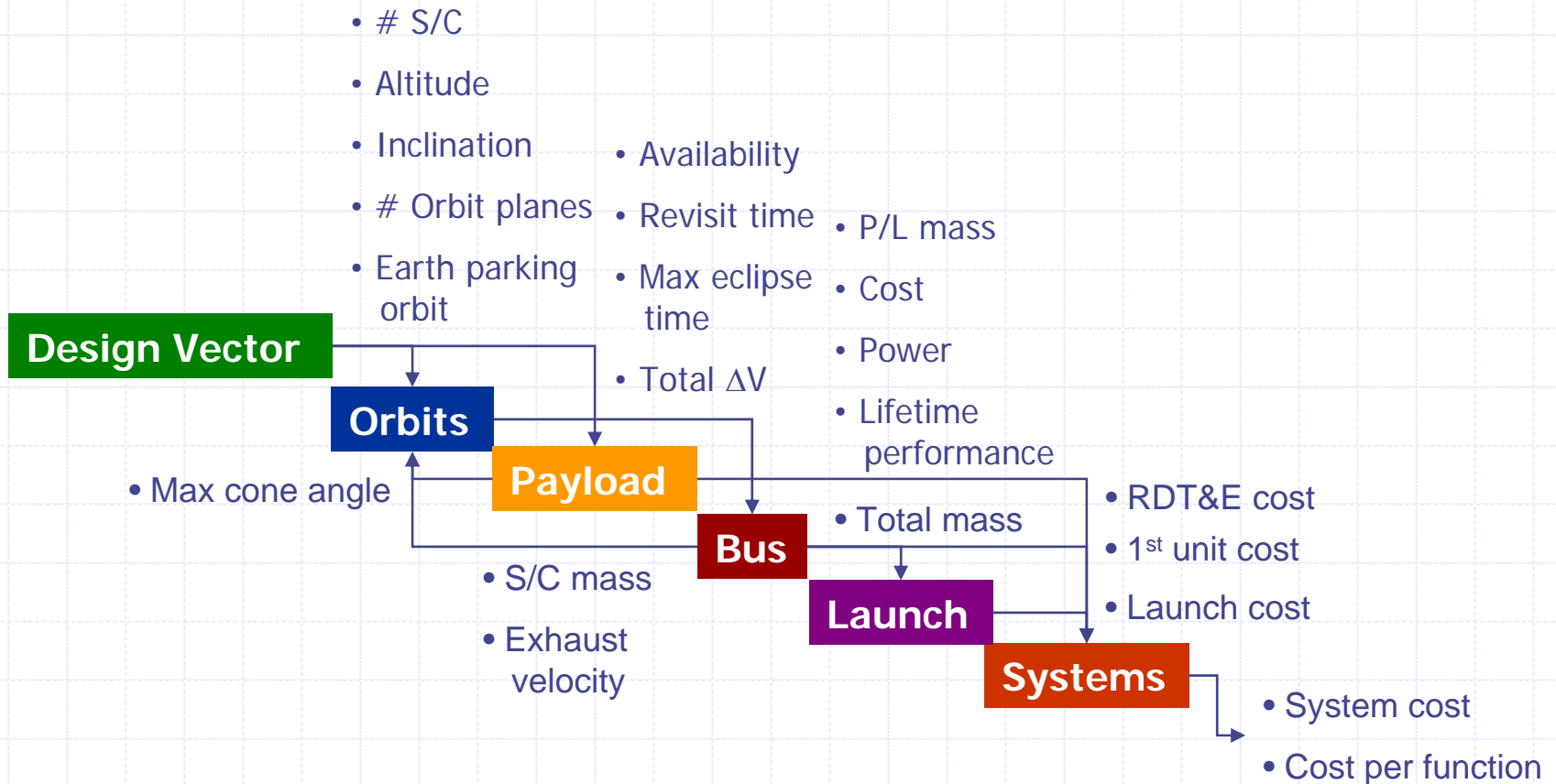

ICE Design Sessions

- ◆ Identified best launch scenario
 - Direct to Mars transfer over LEO parking orbit
 - Switch to chemical propulsion over electric
- ◆ Identified best constellation altitude
 - 2000 km for four spacecraft
 - Minimizes system cost
- ◆ Discovered minimal cost saving with three spacecraft
 - Sacrificing availability and robustness
- ◆ Tweaked inclination orbit
 - Significantly reduces maximum revisit time



Detailed Design: Orbit Analysis

Orbits Requirements

- ◆ **M004** MINERVA shall have a maximum revisit time of less than 3 hours.
- ◆ **M005** MINERVA shall provide a coverage of $\pm 15^\circ$ latitude band around the equator.
- ◆ **S001** Constellation shall have a minimum of 2 spacecraft in view of the Earth at all times.
- ◆ **S007** MINERVA shall have a crosslink availability of 90%.

Transit Method Trade Study

- ◆ Proposed methods for the interplanetary segment
 - Chemical propulsion
 - Electric propulsion
- ◆ Design discriminators from an orbit standpoint
 - Total ΔV for all phases of the mission
 - Time of flight for transit to Mars

	Earth		Interplanetary		Mars	
	ΔV (km/s)	Time (d h)	ΔV (km/s)	Time (d h)	ΔV (km/s)	Time (d h)
Chemical	3.80	2d 17h	0.17	282d 23h	1.60	3d 17h
Electric	7.38	421d 14h	5.66	323d 3h	2.63	150d 1h

Using 185km parking orbit

Transit Method Trade Study

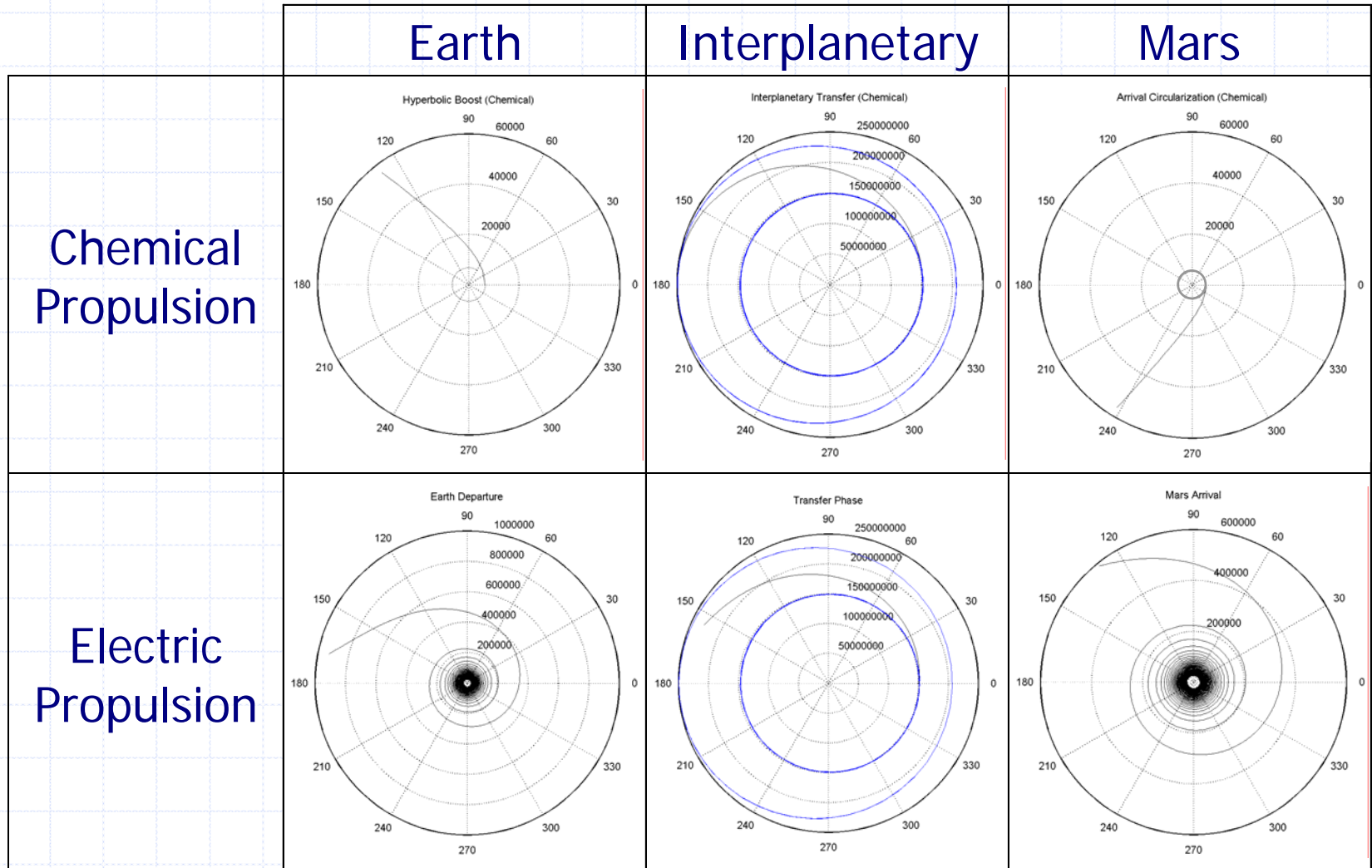

Transit Method Selection

- ◆ Considerations
 - Chemical propulsion provides fast transfer for smaller ΔV
 - Electric propulsion is more benign
 - ◆ More time to react to problems
 - ◆ Smaller forces exerted during maneuvers
- ◆ Conclusion: from orbit standpoint, chemical propulsion is recommended
- ◆ Other groups are involved in this trade
 - Bus Group
 - System Group (Cost)

Launch Opportunities

- ◆ Each Earth-Mars launch window has a slightly different ΔV requirement
- ◆ The MINERVA design can accommodate all three launch opportunities investigated
- ◆ The launch window in 2009 may be used as a backup opportunity, with system IOC on 23 Sep 2010

Launch	Departure ΔV	Capture ΔV	Time of Flight
2005	3.726 km/s	1.742 km/s	278d 15h 35m
2007	3.799 km/s	1.601 km/s	290d 8h 22m
2009	3.712 km/s	1.753 km/s	278d 21h 54m

Delta III Launch Sequence

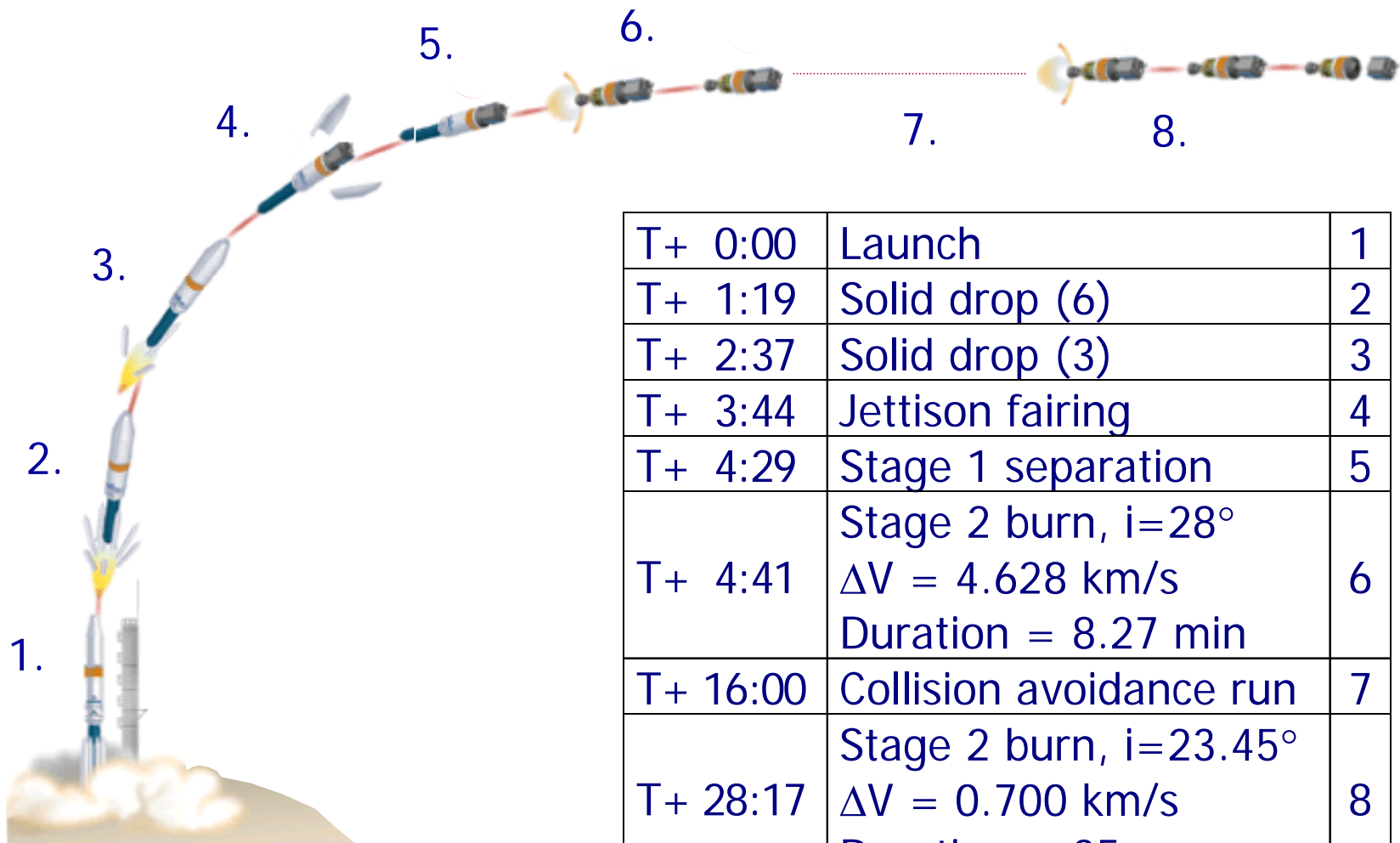

T+ 0:00	Launch	1
T+ 1:19	Solid drop (6)	2
T+ 2:37	Solid drop (3)	3
T+ 3:44	Jettison fairing	4
T+ 4:29	Stage 1 separation	5
T+ 4:41	Stage 2 burn, $i=28^\circ$ $\Delta V = 4.628 \text{ km/s}$ Duration = 8.27 min	6
T+ 16:00	Collision avoidance run	7
T+ 28:17	Stage 2 burn, $i=23.45^\circ$ $\Delta V = 0.700 \text{ km/s}$ Duration = 35 sec	8

Transit - Departure

T+ 3:23:20	Departure burn (second stage) $\Delta V = 3.799$ km/s Duration = 5.59 min
T+ 3:29:30	Start release sequence Interval = 50.15 min
T+ 6:01:00	Despin maneuver
T+ 6:01:50	Deploy solar arrays
T+ 6:05:00	Initial checkout
T+ 2d 16:39	Depart Earth SOI

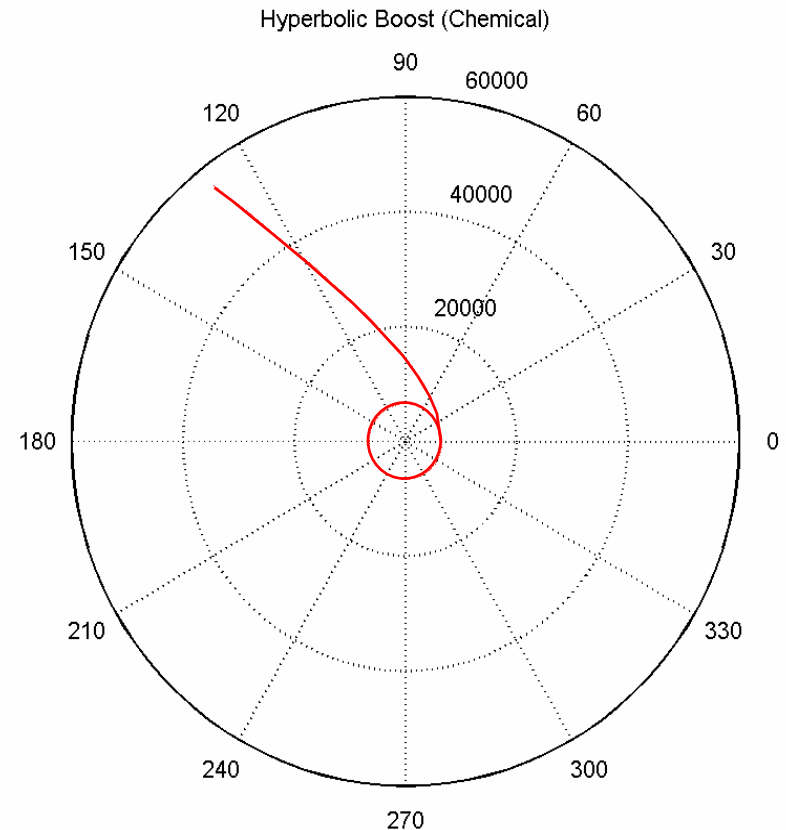

Fairing Jettison

Satellite Separation

Solar Array Deployment

Solar Arrays gimbaled about North-South axis

Cross-Link Deployment

Deploys on hinged boom

Transit - Rendezvous

T+ 2d 16:39	Alignment burn (four ACS thrusters) $\Delta V = \sim 0.020$ km/s Duration = 48.2 sec
T+ 2d 16:45	Functional testing
T+ 122d 16:00	Correction burn (four ACS thrusters) $\Delta V = \sim 0.005$ km/s Duration = 12.0 sec
T+ 285d 00:00	Upload precise position
T+ 285d 01:00	Spin-up maneuver
T+ 285d 14:29	Arrive Mars SOI (29 May 2008)

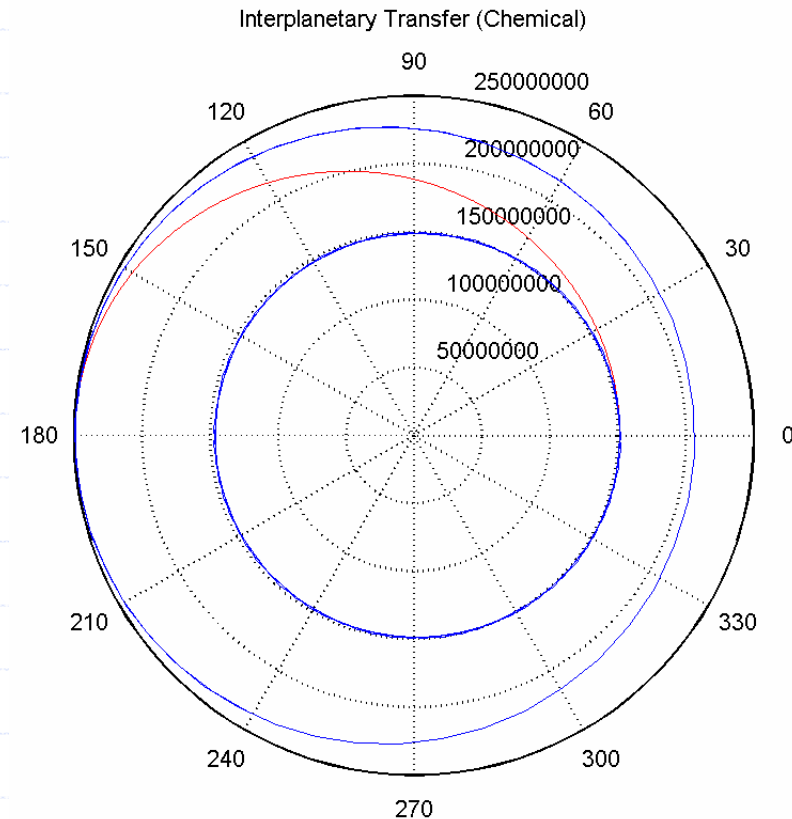

Capture and Deployment

T+ 285d 14:29	Injection burn (main kick motor) $\Delta V = 0.167$ km/s Duration = 2.1 sec
T+ 290d 08:22	Circularization burn (main kick motor) $\Delta V = 1.602$ km/s Duration = 19.1 sec
T+ 290d 08:23	Despin maneuver
T+ 290d 08:24	Deploy large antenna
T+ 290d 10:54	All satellites in place
T+ 291d 12:00	Correction maneuvers (as necessary)
T+ 296d 12:00	Test and calibration
T+ 326d 01:40	IOC: 9 July 2008

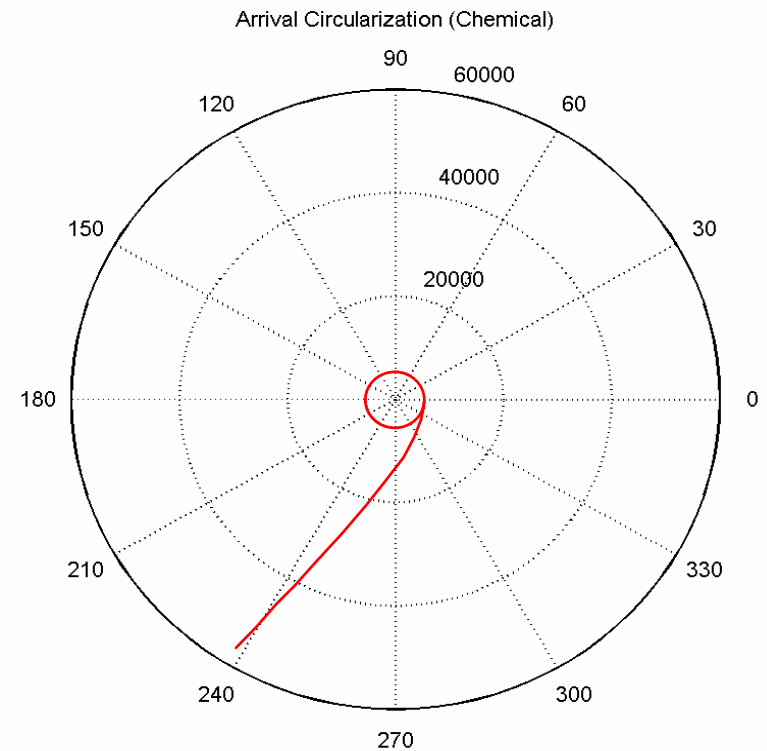

Earth-Antenna Deployment

- ◆ Full pointing capabilities using 2 DOF boom

Fully Deployed Satellite

- ◆ Nominal mission configuration

Lifetime Visibility

- ◆ Earth-Mars distance is periodic over 2.2 years
- ◆ Exclusion zone of 19 days caused by line-of-sight intersection with the sun and its corona

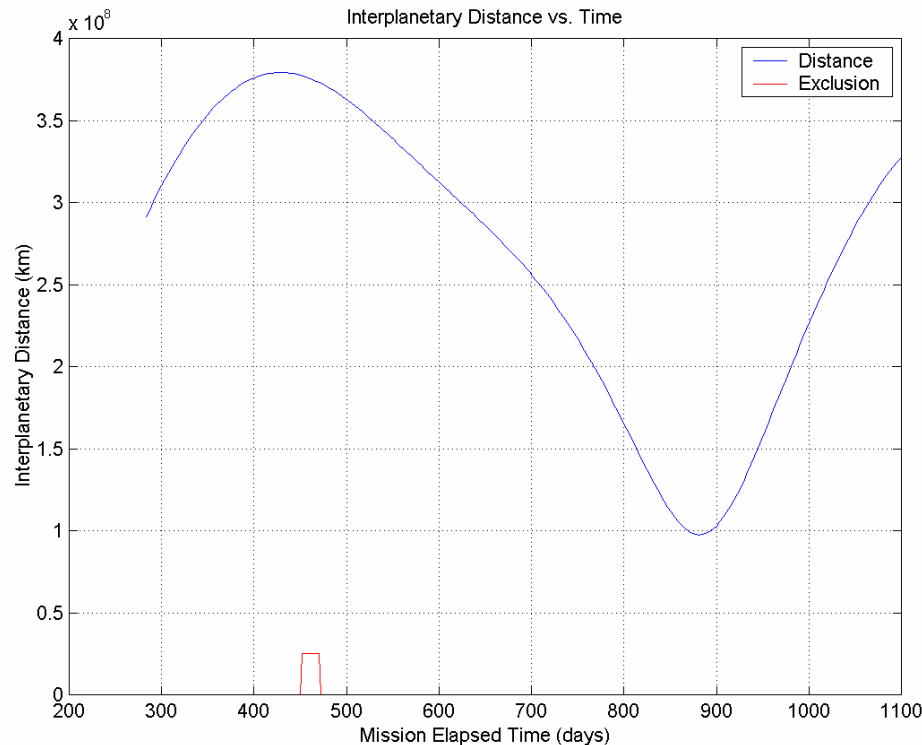

Constellation Constraints

- ◆ Recap of requirements
 - Provide coverage to a $\pm 15^\circ$ latitude band
 - Minimum MSE to satellite availability of 50%
 - Maximum revisit time of 3 hrs
- ◆ Architecture constraints
 - Allow for line of sight communications between satellites
 - Minimum inclination of $\approx 30^\circ$

Trade Spaces

- ◆ Coverage requirements
 - Altitude
 - Number of satellites
 - Inclination (restricted by the position determination requirement)
- ◆ Constrained by the cross-link requirements
 - Altitude
 - Number of satellites
- ◆ Cost (looked at in ICE sessions)
 - Altitude
 - Number of satellites

Coverage Trade Space

- ◆ Constrained by:
 - Revisit time < 3 hrs
 - 50% availability
- ◆ Variables:
 - Number of satellites
 - Inclination
 - Altitude

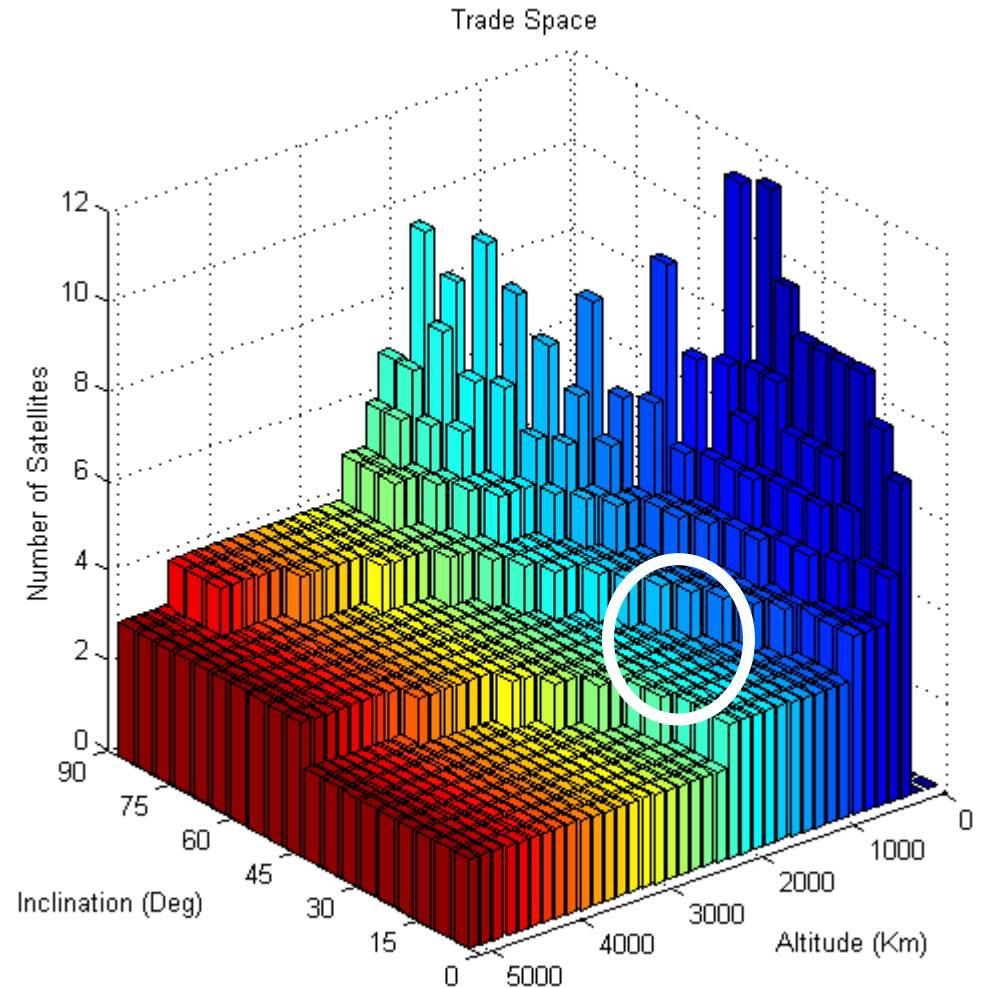

Cross-link Trade Space

- ◆ Minimum altitude required for cross-links
- ◆ Signal beams pass at least 200 km above the surface of Mars

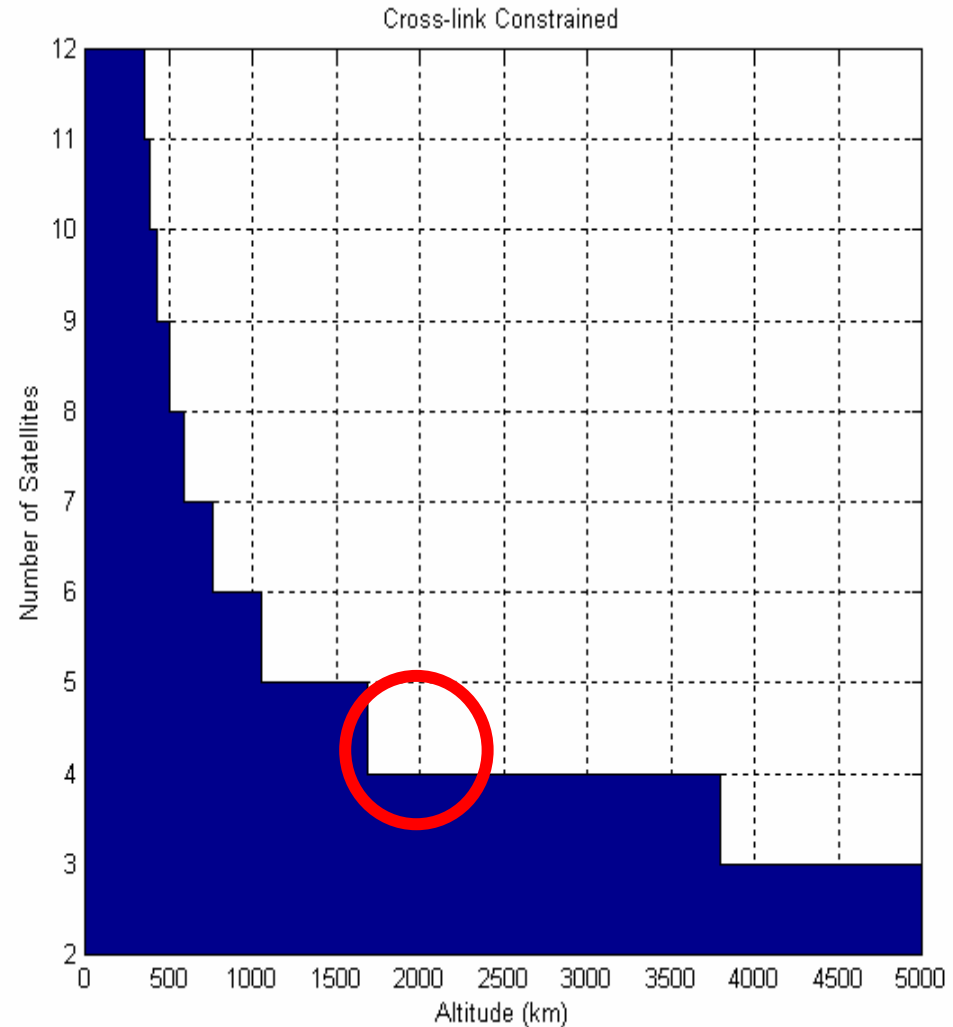

Final Constellation Design

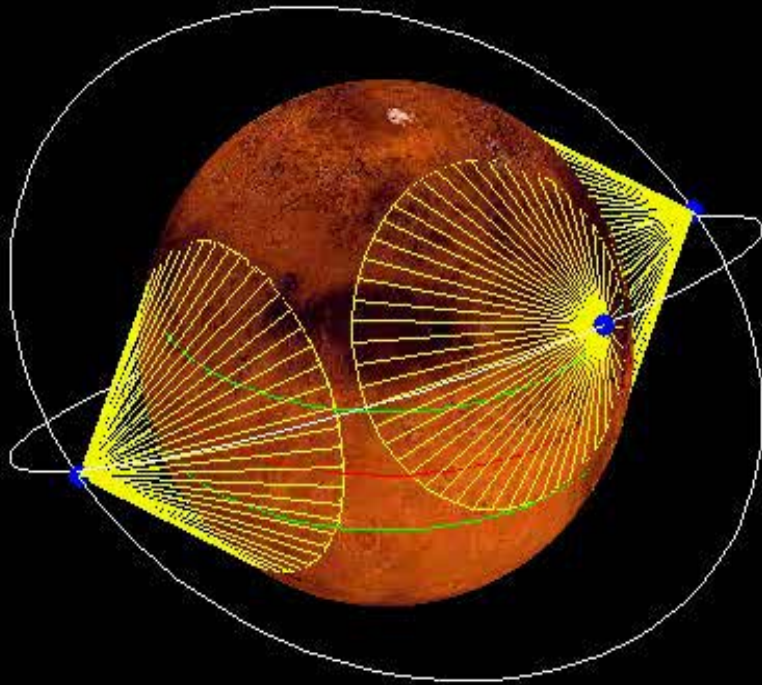

- ◆ Walker-Delta pattern
- ◆ Circular orbits
- ◆ 2 Planes
- ◆ 4 Satellites
- ◆ 27° Inclination

Percentage of Time in View

- ◆ Constellation provides $>70\%$ coverage in the $\pm 15^\circ$ latitude band
- ◆ Reduced coverage up to $\pm 65^\circ$

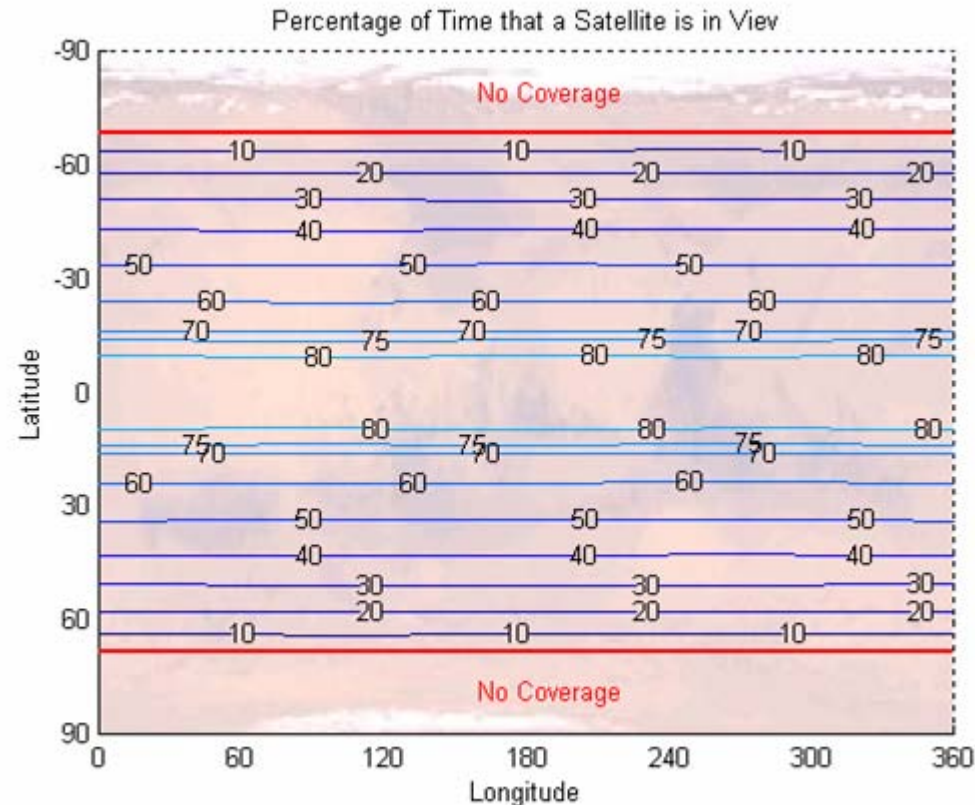

Revisit Time

- ◆ The maximum time between satellite passes is < 30 min
- ◆ The average time is < 20 min

Maximum Revisit Time (min.)

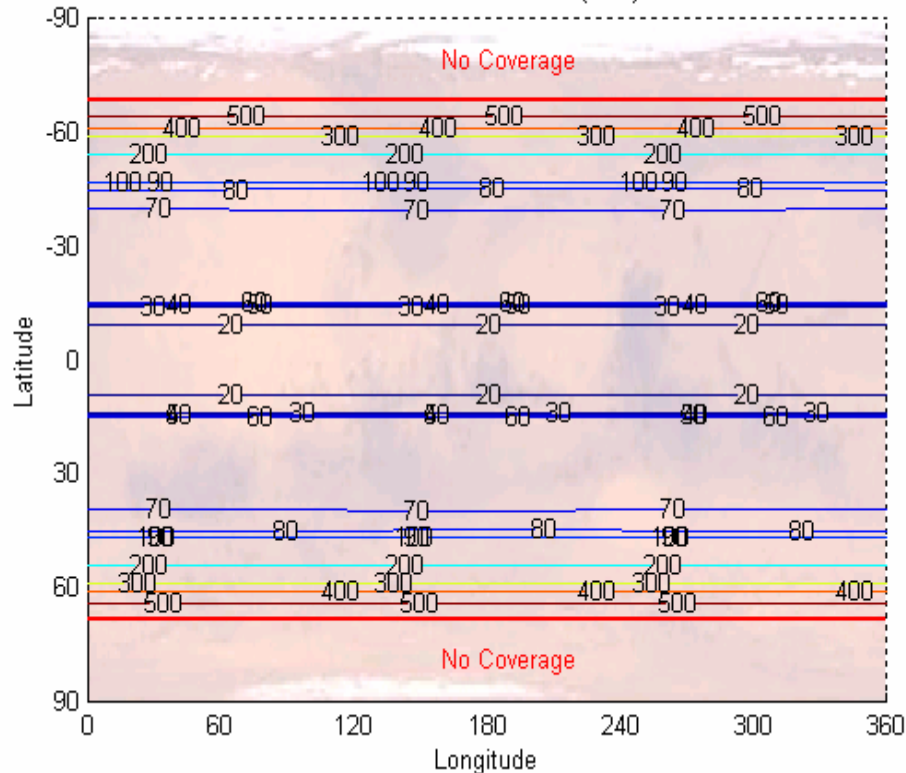

Average Revisit Time (min.)

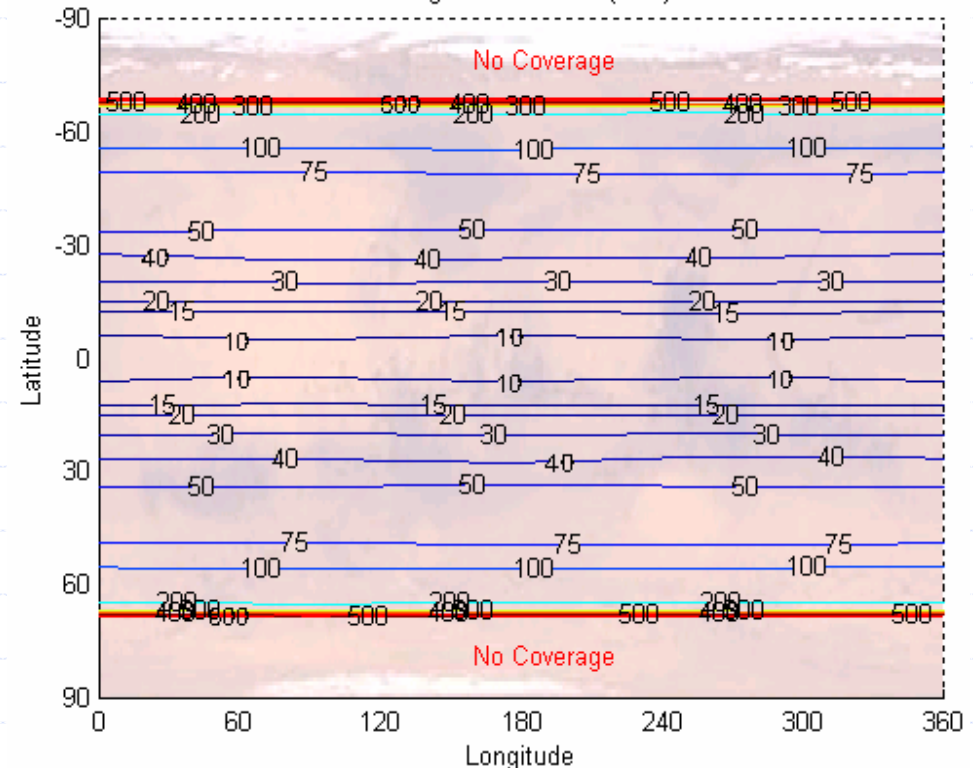

Contact Duration

- ◆ On average, a satellite will remain in view for 50 minutes.

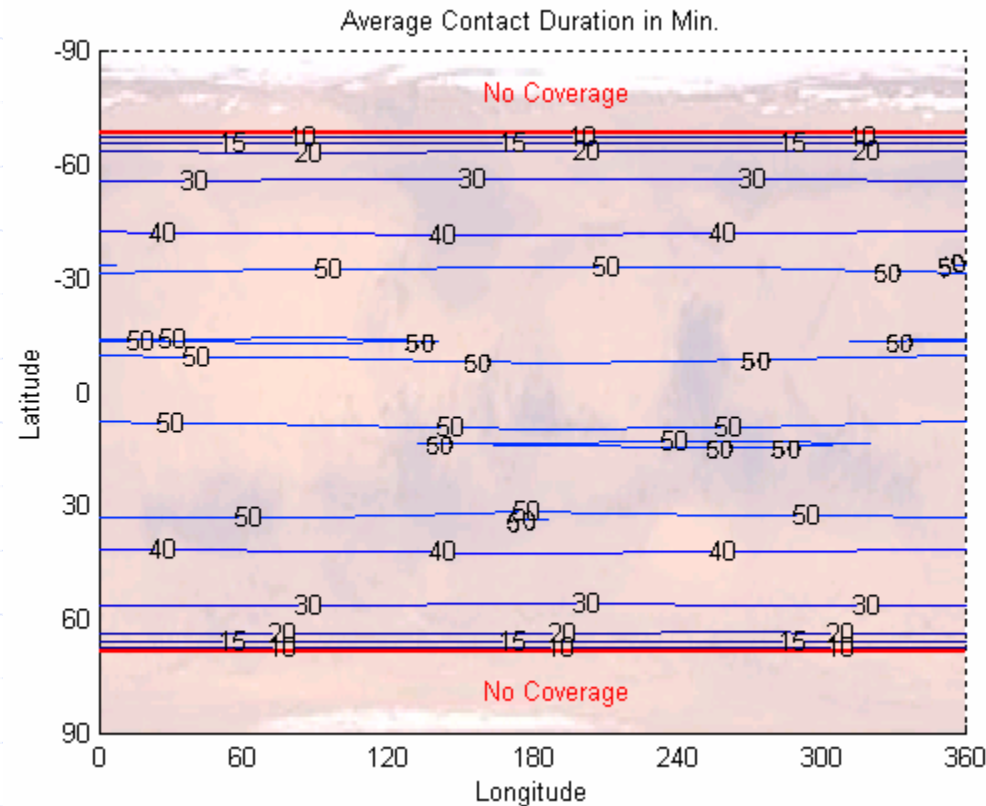

Final Constellation Design

- ◆ Walker-Delta pattern
- ◆ 4 satellites in 2 planes
- ◆ Inclination of 27°
- ◆ Provides ($\pm 15^\circ$ Lat)
 - Avg. revisit time < 20 min
 - Max. revisit time < 30 min
 - Contact duration \approx 50 min
 - Availability > 70%
 - 3 satellites in view of Earth
 - Reduced coverage up to ($\pm 60^\circ$ Lat)

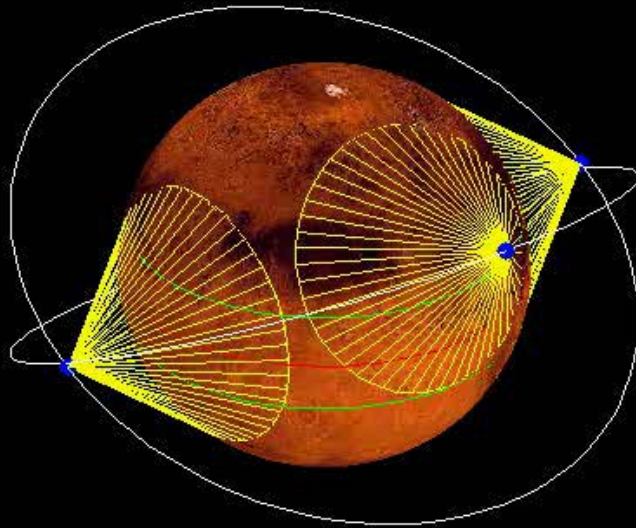

Single Satellite Failure

- ◆ In the event of a single satellite failure, the constellation will be able to provide communication and navigation at a diminished level

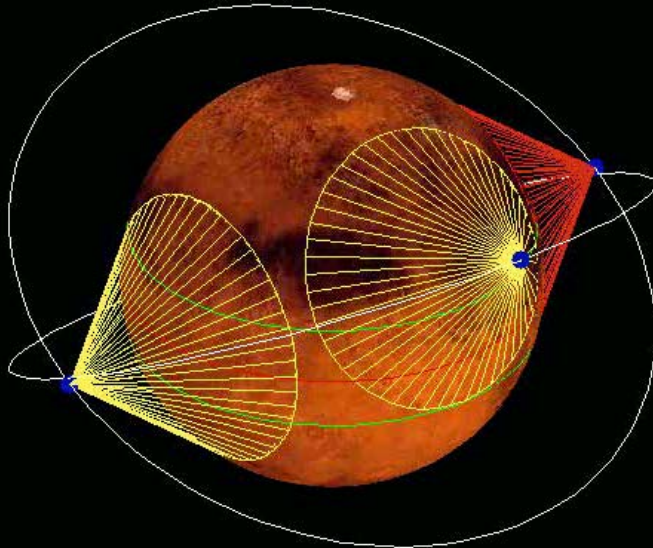

- ◆ Provides ($\pm 15^\circ$ Lat)
 - Avg. revisit time < 45 min
 - Max. revisit time < 100 min
 - Contact duration \approx 50 min
 - Availability > 50%
 - At least 2 satellites in view of Earth



Detailed Design: Payload Analysis

Payload Requirements

- ◆ **M001** MINERVA shall provide communication capability between MSEs and EGS for at least 10 continuous hours per day.
- ◆ **M002** MINERVA shall provide MSE position accuracy of 100 m (horizontal resolution) or less.
- ◆ **M003** MINERVA shall return MSE position determination daily with an update every 3 hours.
- ◆ **S005** Constellation shall return a minimum of 10 Gb/sol data rate to EGS.

Payload Requirements (cont.)

- ◆ **E002** EGS shall be able to resolve spacecraft orbit to an accuracy of 20 m in radial, along-track, and cross-track directions.
- ◆ **E003** EGS shall be able to upload spacecraft orbital element data and clock offsets at least once per day.
- ◆ **E008** Uplink from EGS to MINERVA shall have a BER of no greater than 10^{-9} .
- ◆ **E009** Uplink from EGS to MINERVA shall have a data rate of at least 500 bps.

Payload Requirements (cont.)

- ◆ P001 Payload mass shall not exceed 50 kg.
- ◆ P002 Payload shall use UHF for communication with MSEs.
- ◆ P003 Uplink from MSE to MINERVA shall have a BER of no greater than 10^{-6} .
- ◆ P004 Payload shall have a downlink BER no greater than 10^{-6} .
- ◆ P005 Each satellite shall have a downlink data rate of at least 150 kbps from MINERVA to EGS.

Payload Requirements (cont.)

- ◆ **P006** Payload shall dynamically allocate downlink data rate and uplink from MSE to constellation data rate.
- ◆ **P007** Payload shall provide 30 Gb storage for communication data.
- ◆ **P008** Payload subsystem shall use an on-board orbital propagator with an accuracy of 10 km for backup.



Payload Analysis: Communication

Communications Requirements

- ◆ Communication system
 - Relay between Mars Surface Elements (MSEs) in the $\pm 15^\circ$ latitude band and the Earth.
 - Exceed 10 Gb/sol of total data return

Communication System Overview

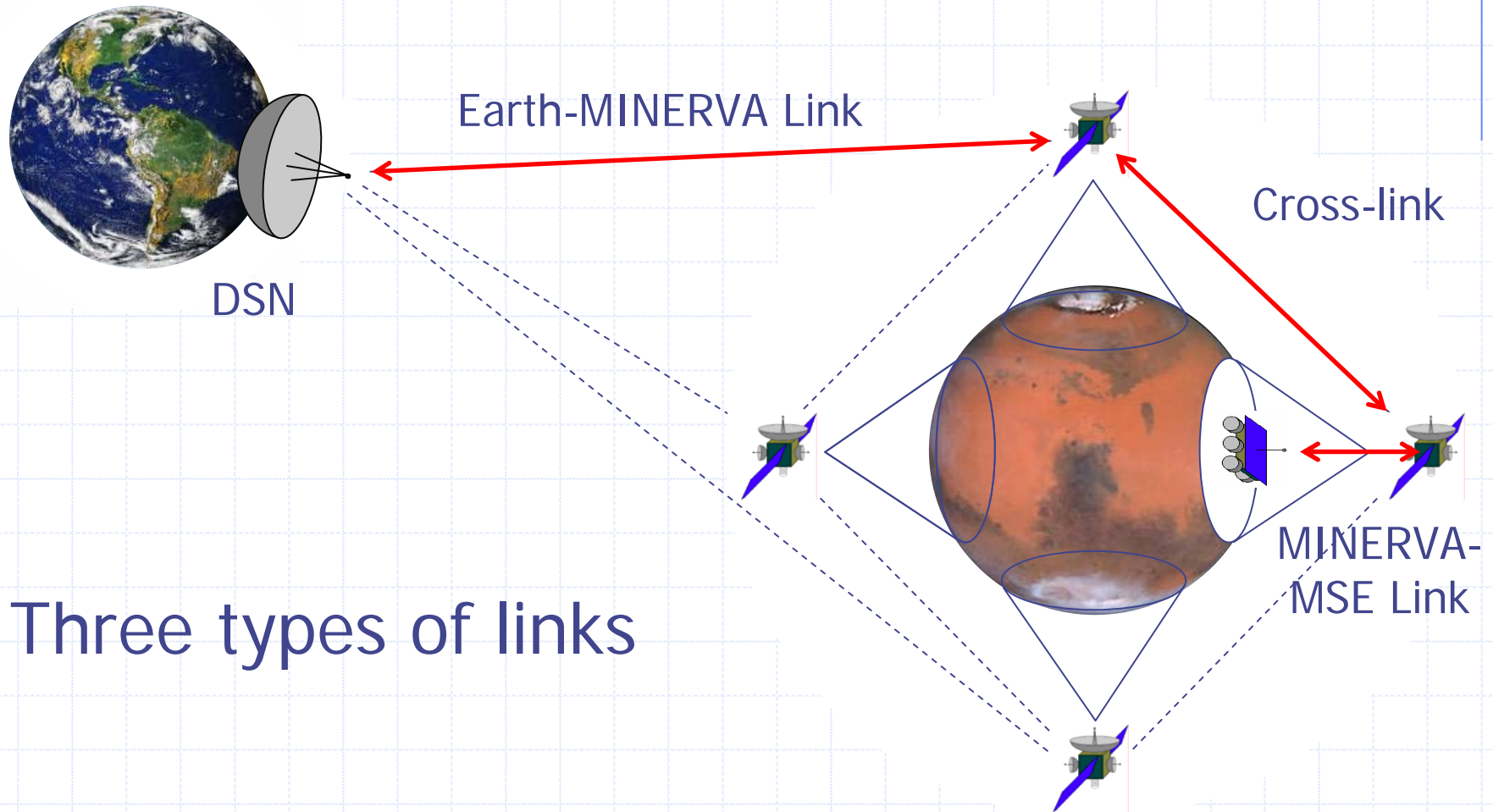

Antenna Types Analysis

Parabolic antenna

- ◆ Optimized for high gain (>20 dB) and low beamwidth (order of 15 deg or less)
- ◆ Has a lot of experience in space

Image removed due to copyright restrictions.

Image removed due to copyright restrictions.

Helix antenna

- ◆ Optimized for frequencies below 2 GHz
- ◆ Best suited for low gain and high beamwidth
- ◆ Light mass

Antenna Types Analysis

Phased array antenna

- ◆ Generates one or more beams simultaneously
- ◆ Changes direction of the beam rapidly
- ◆ Sweeps good gain over a large beamwidth (e.g. 14 over 120°)
- ◆ No moving mechanical parts

Image removed due to copyright restrictions.

Image removed due to copyright restrictions.

Horn antenna

- ◆ Optimized for frequencies of 4 GHz or higher
- ◆ Best suited for low gain and high beamwidth
- ◆ High weight

Top Level Trade Analysis for the Communication System

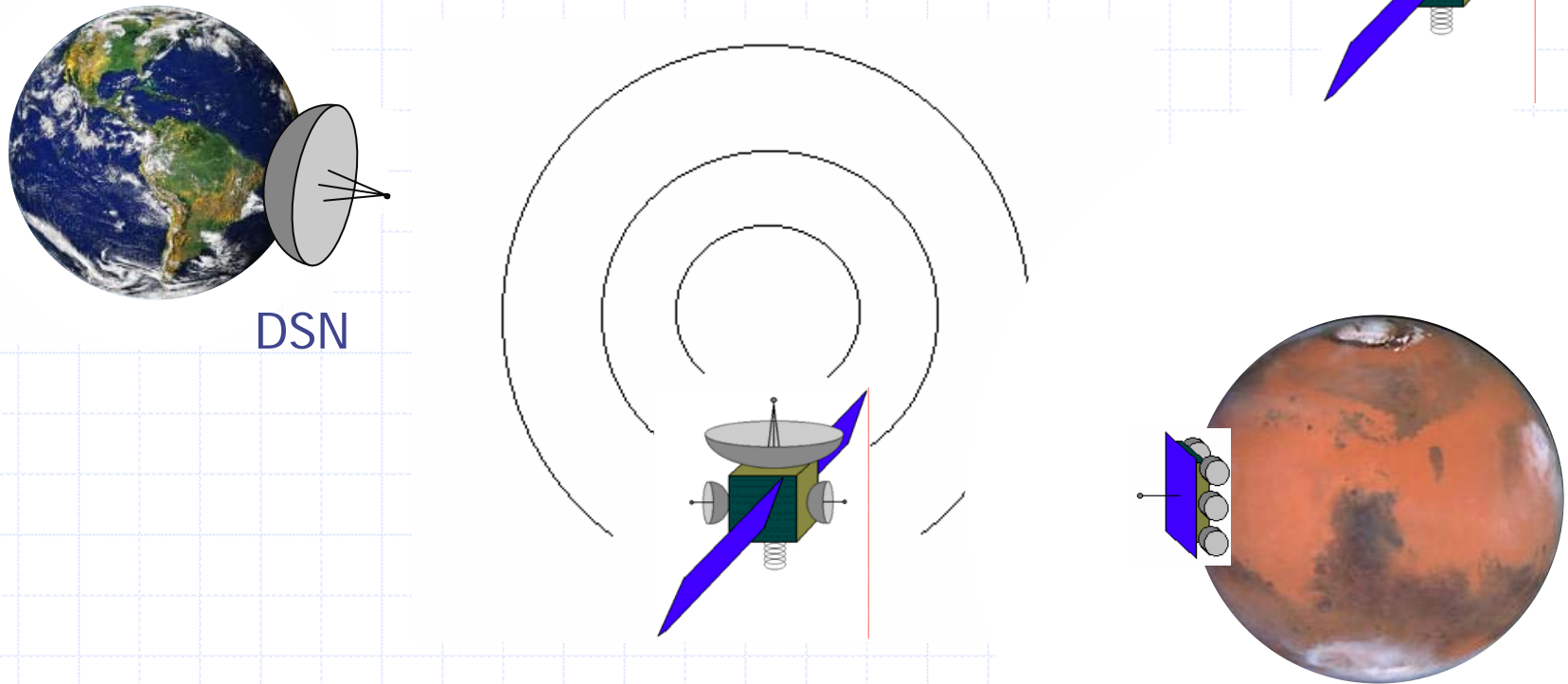

Case 1: Integrating all links together in one antenna

1) Omnidirectional antenna

- Inefficient use of available power

Top Level Trade Analysis for the Communication System

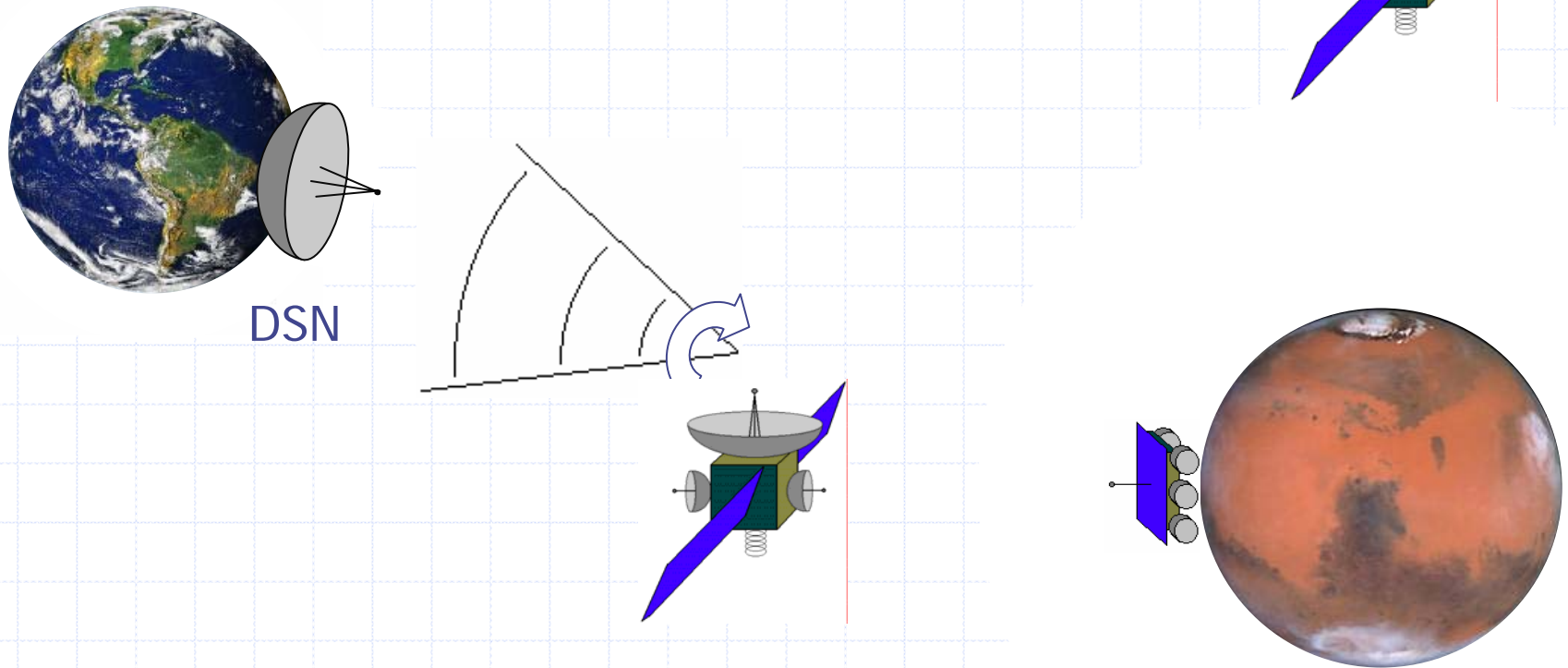

Case 1: Integrating all links together in one antenna

2) Directional antenna

- Impossible to communicate between Mars and Earth at the same time (parabolic reflector and phased array antenna)

Top Level Trade Analysis for the Communication System

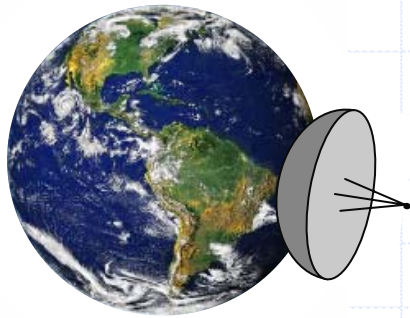

DSN

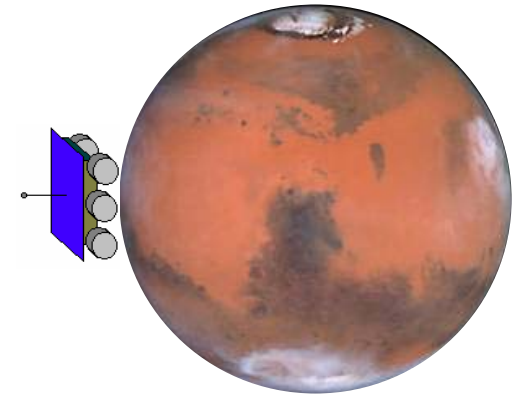
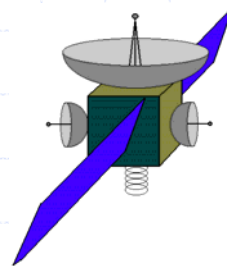
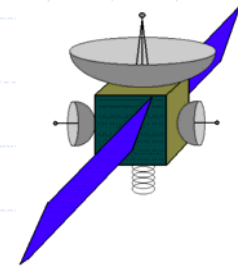

Case 1: Integrating all links together in one antenna

Conclusion:

- Integrating all links together is not the optimal solution

Top Level Trade Analysis for the Communication System

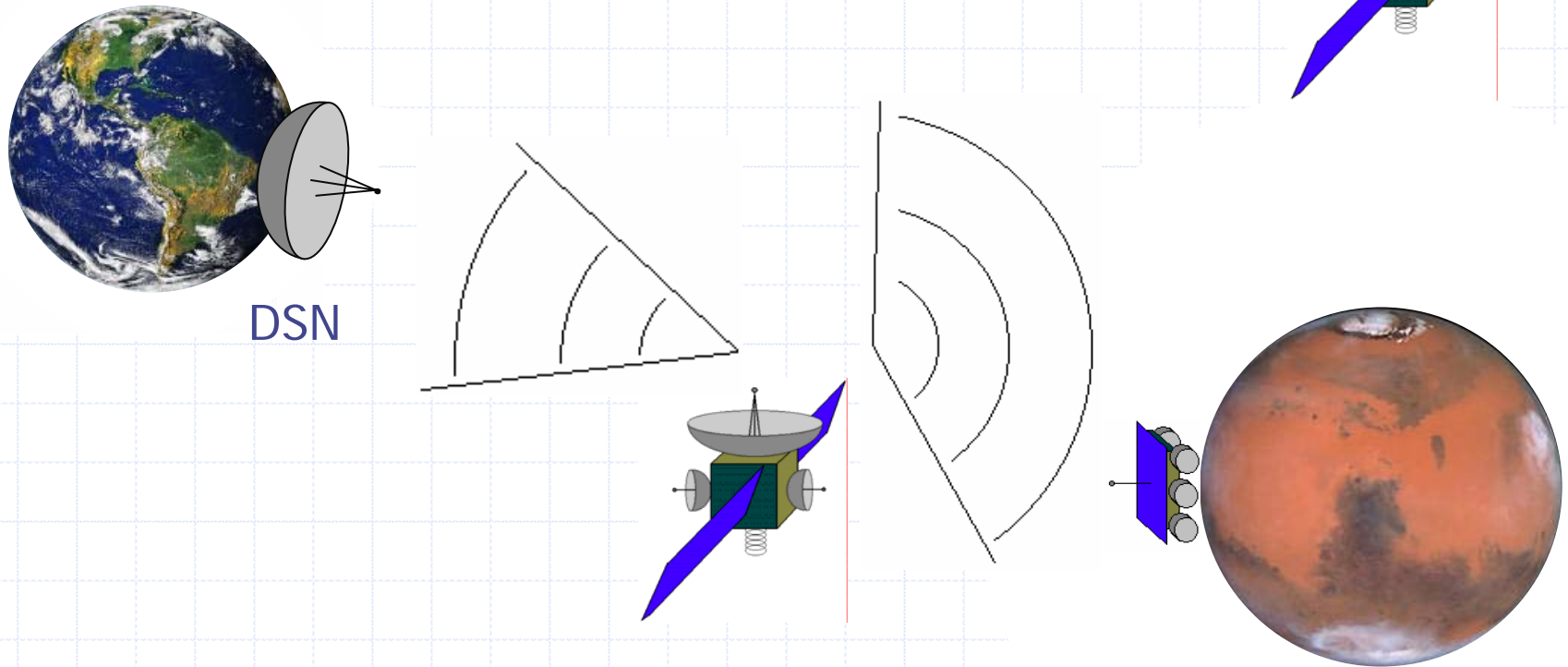

Case 2: Integrating cross-link and MINERVA-MSE

1) Using a helix type antenna or a parabolic antenna

- Not enough gain for that large beamwidth

Top Level Trade Analysis for the Communication System

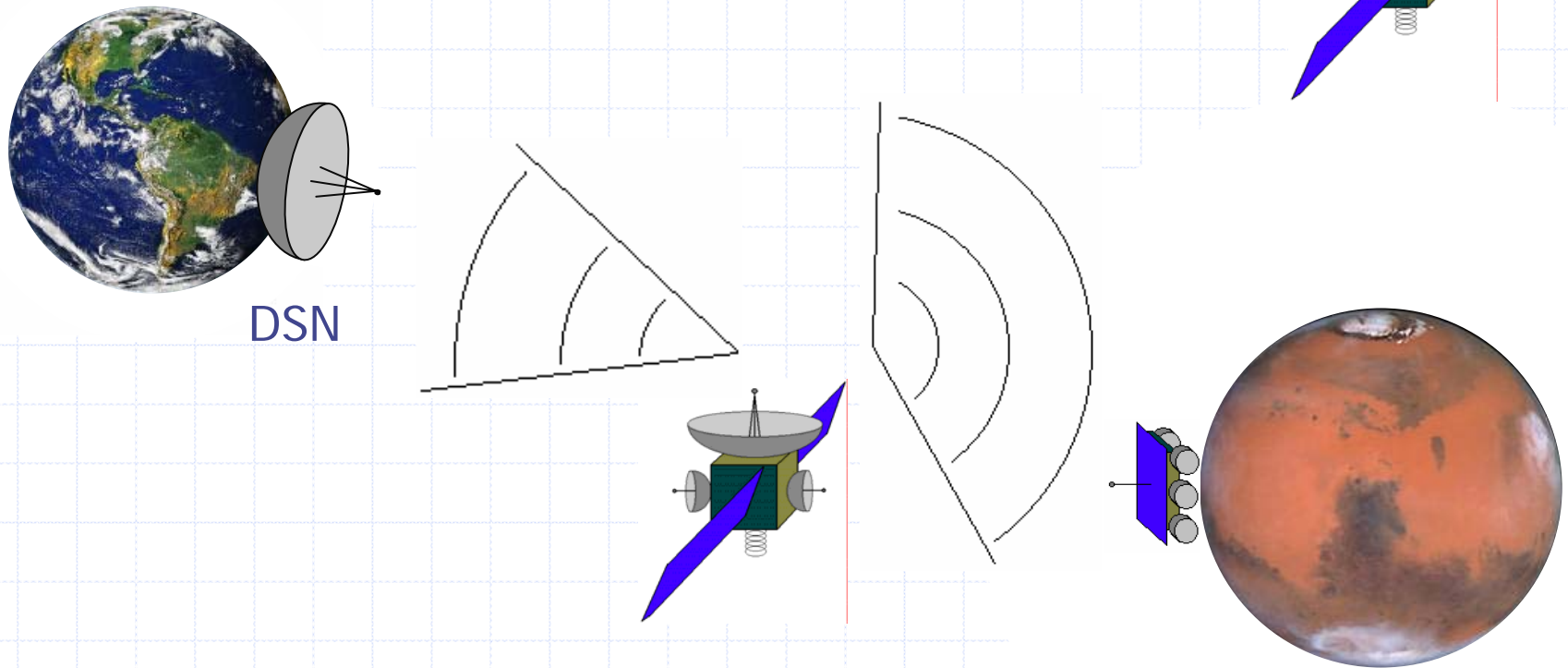

Case 2: Integrating cross-link and MINERVA-MSE

2) Using a phased array antenna

- UHF phased array antenna have not been used for space communication

Top Level Trade Analysis for the Communication System

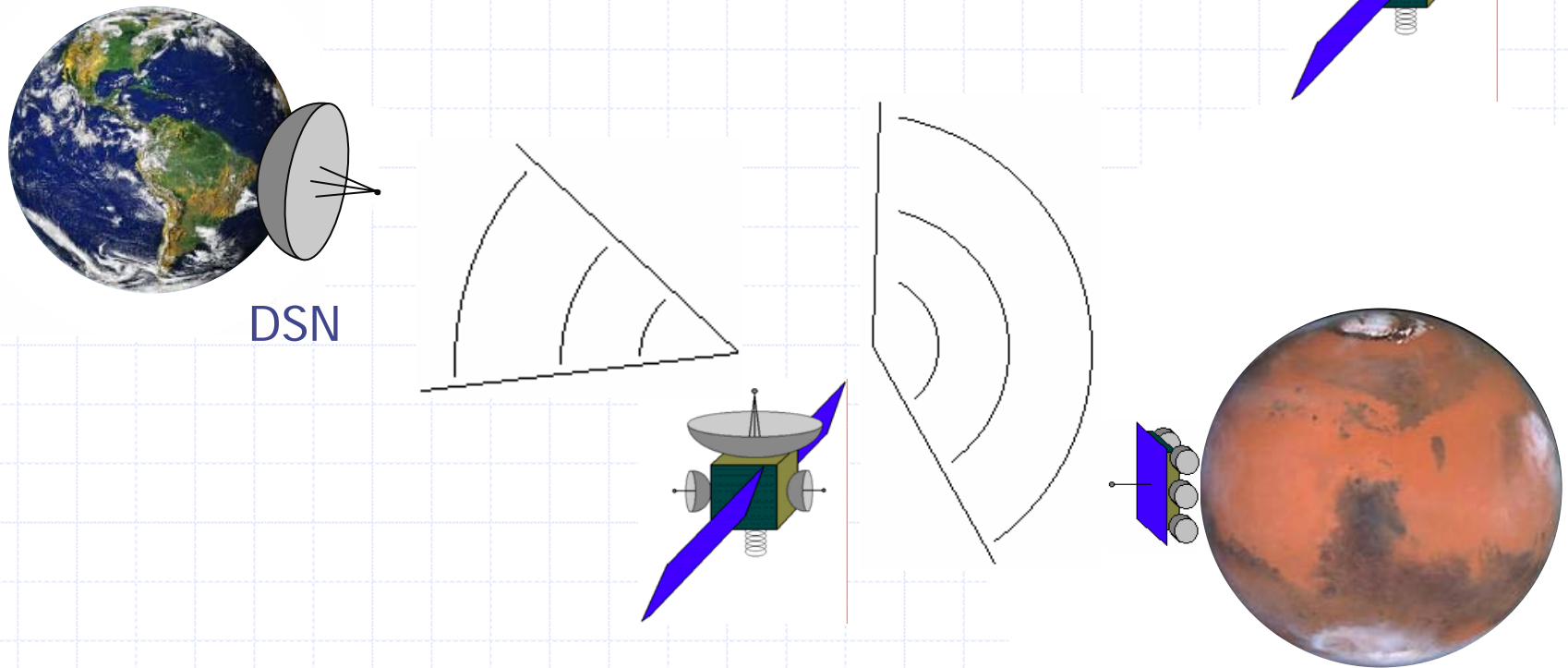

Case 2: Integrating cross-link and MINERVA-MSE

Conclusion:

- Integrating cross-link and MINERVA-MSE is not the optimal solution for this application

Top Level Trade Analysis for the Communication System

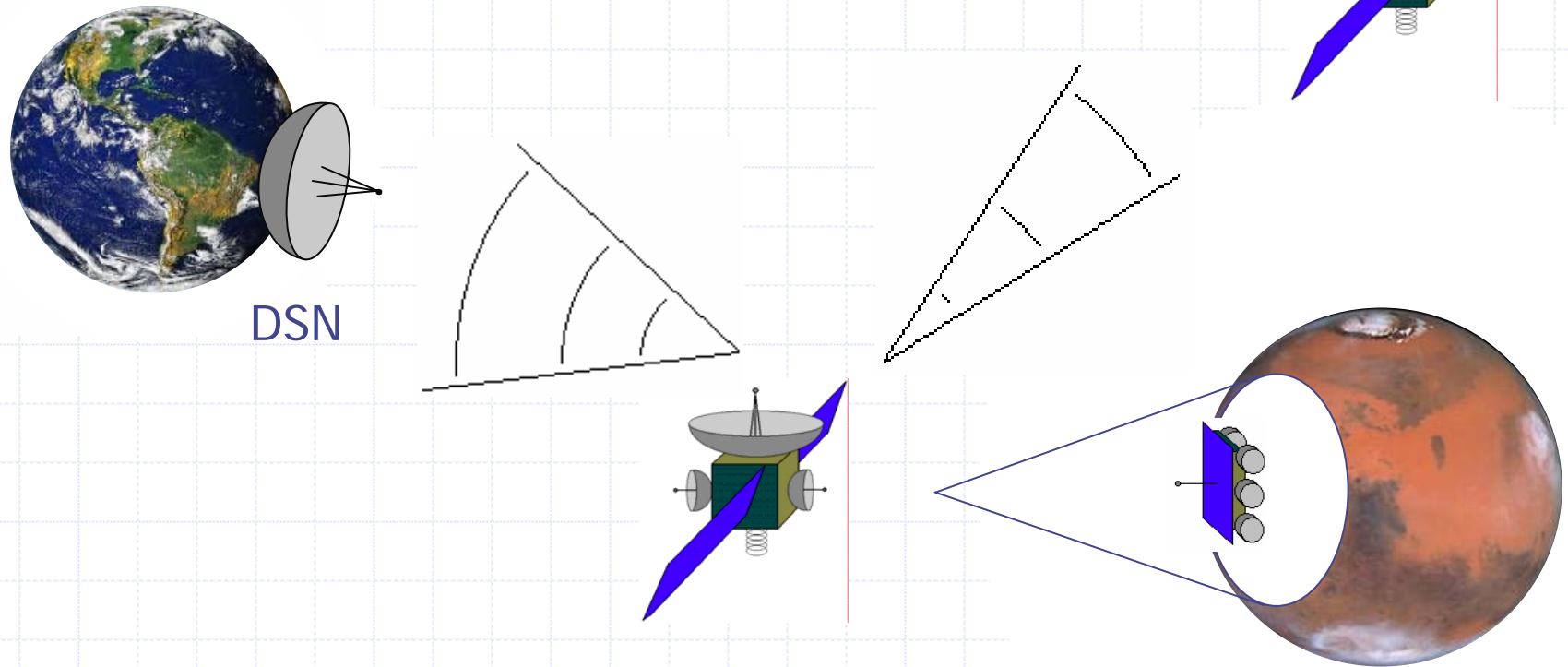

Case 3: Separating each type of link

One different type of antenna per link

Top Level Trade Analysis for the Communication System

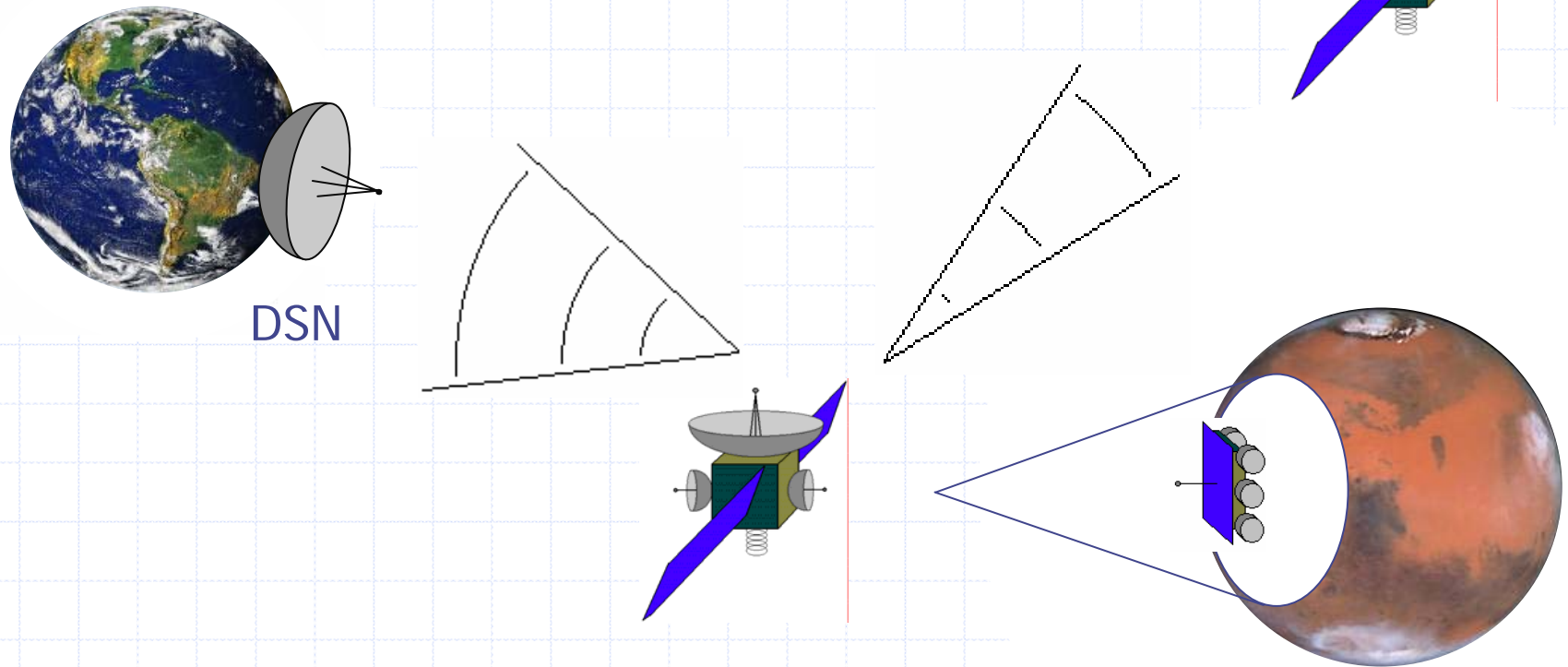

Case 3: Separating each type of link

Conclusion:

- Separating each type of link is the solution chosen

Earth Ground Station Interface

- ◆ Deep Space Network: 70-m vs. 34-m antennas

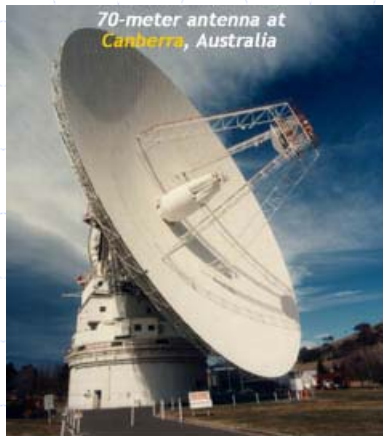

- ◆ 34-m: availability of Ka-band allows reduced satellite antenna size
- ◆ 34-m: processing facilities located on the ground
 - Better thermal control - reduced system noise
 - Smaller operation cost

Modulation used

- ◆ BPSK R-1/2 Viterbi software decoding
 - Standard deep space telemetry modulation format

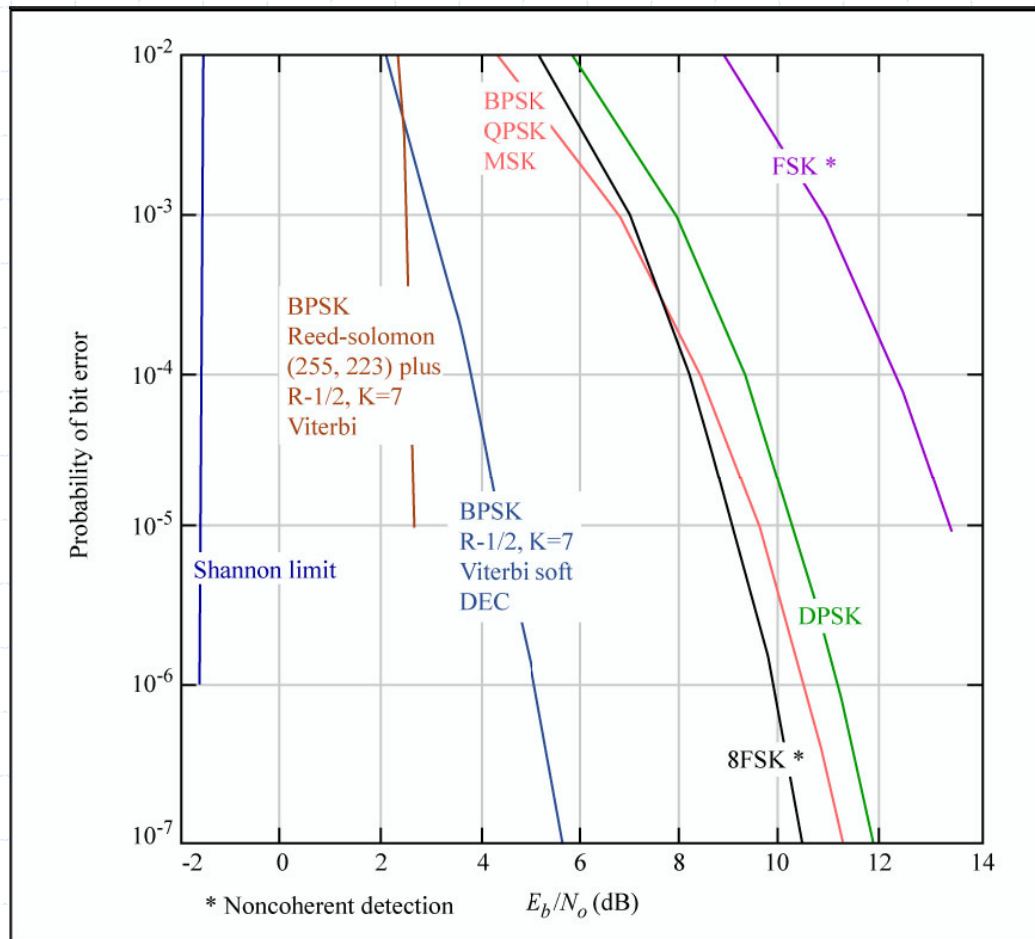

Respects
Shannon
Limit

Figure by MIT OpenCourseWare.

Frequencies used

- ◆ Ka-band (32 GHz) for Earth-MINERVA link
 - Reduces the size of the antenna while keeping a high gain
 - Will be supported by DSN
 - Also used during Earth-Mars transit
- ◆ X-band (7 GHz) for cross-link
 - Provides good beamwidth without significantly influencing the antenna diameter (medium gain)
 - Widely used in deep space missions
- ◆ UHF (0.4 GHz) for MINERVA-MSE link
 - Good performance for omnidirectional antennas on Mars surface
 - Reduces necessary antenna mass on board MSE

Antenna Types Trade Analysis

- ◆ MINERVA - Earth link: Parabolic antenna
 - Mars Earth distance: 50 - 400 million km
⇒ high gain required
- ◆ MINERVA - Mars link: Helix antenna
 - UHF 0.4 GHz to support existing assets
 - High beamwidth to improve coverage
(77 deg at 2000 km altitude)
- ◆ MINERVA cross-links: Parabolic antenna
 - Necessity to use antenna for Earth link during Mars approach and as a backup

Payload Hardware

Antennas and Transponders	Other Hardware
MINERVA-Earth Link: Ka-(X)-band 2.05 m parabolic, 130 W, 26.6 kg	Computer: RAD 6000, 5 kg Used on Mars Pathfinder, Globalstar, ISS
MINERVA-Mars Link: UHF ∅ 25 cm x 31 cm helix, 21 W, 2.9 kg	Navigation Equipment: Ultra Stable Oscillator, 0.2 kg
MINERVA Cross-Link: X-(Ka)-band 2 x 50 cm parabolic, 5 W, 5.6 kg 2 Omni-directional, 5 W, 0.3 kg	Other equipment: Switches, etc. 2 kg
Total Mass: 35.4 kg	Total Mass: 7.2 kg

Total Payload Mass: 42.5 kg

Payload Mass Breakdown

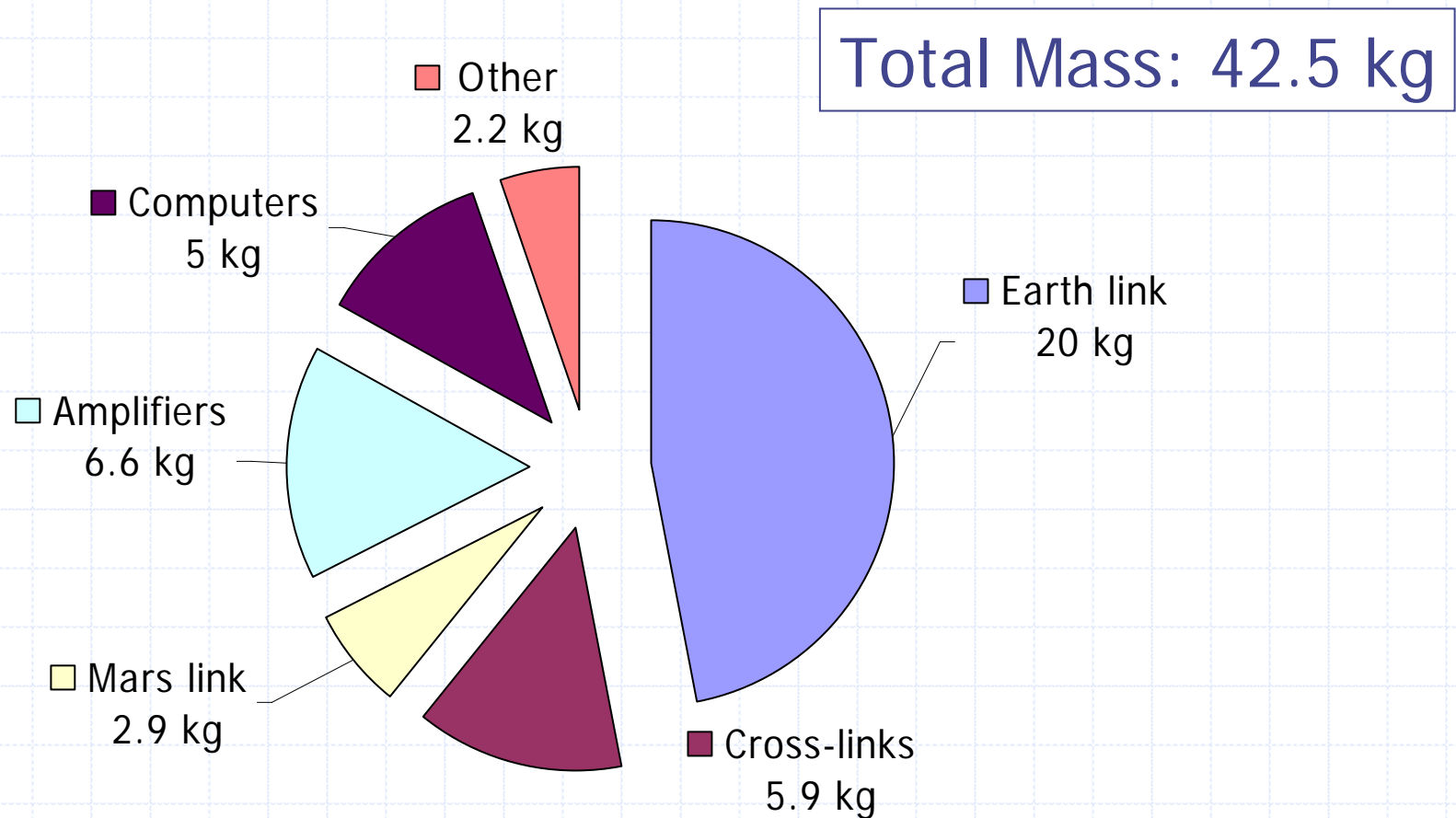

Communications

F.O.V. Verification

- ◆ Use model to verify clear “lines of sight” between satellites, Mars and Earth



Payload Analysis: Position Determination

Position Determination Requirements

- ◆ Position determination system
 - Gather information to determine position of Mars Surface Elements (MSEs) in the $\pm 15^\circ$ latitude band
 - With an accuracy of 100 m
 - With an average update period of less than 3 hours

Positioning Design Trades

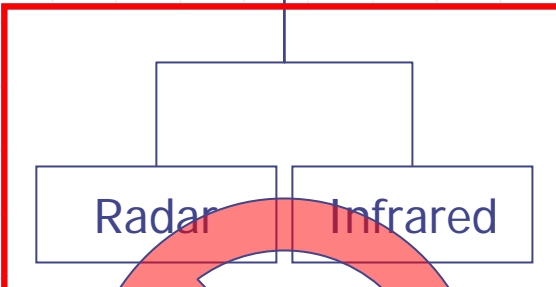
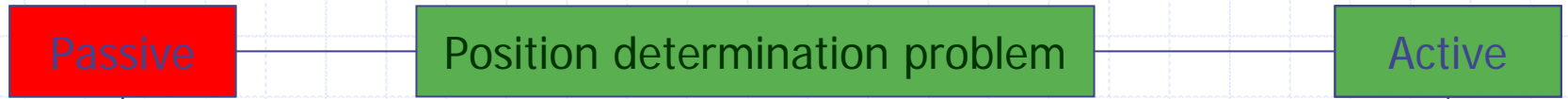

Pros

- No requirement on user
- Single coverage for 2-D
Double coverage for 3-D

Cons

- Infrared not proven
- Computational load

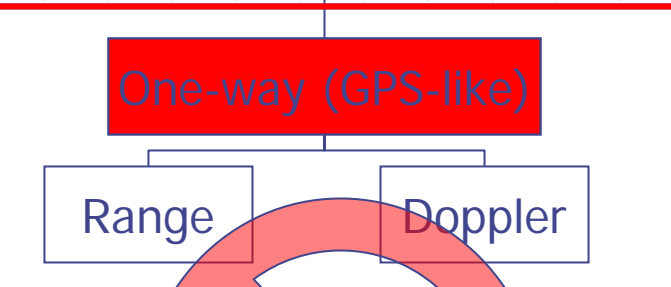

Pros

- Unlimited #users
- Proven methods

Cons

- Time offset Frequency offset
- Triple coverage for 2-D
Quadruple coverage for 3-D

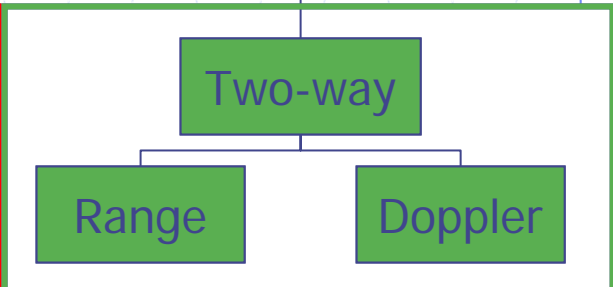

Pros

- Quick 2-D positioning with single satellite
- Double coverage for 2-D
Triple coverage for 3-D

Cons

- Limited #users
- Transponders on user

Position Determination Method

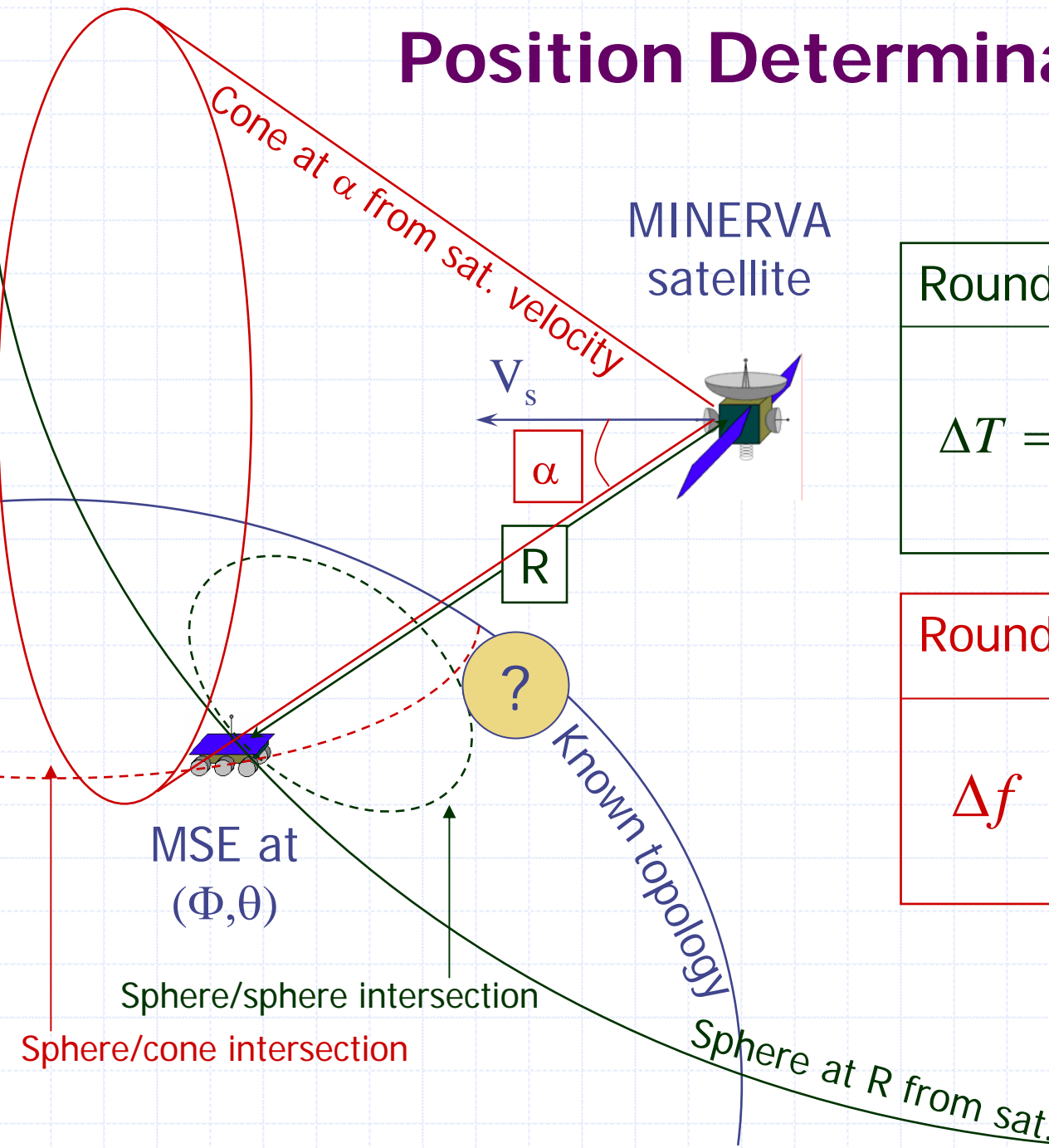

Roundtrip delay:

$$\Delta T = \frac{2R}{c} + \Delta t_{\text{processing delay}}$$

Roundtrip Doppler shift:

$$\Delta f = \frac{2V_s \cos(\alpha)}{\lambda}$$

Ambiguity Resolution

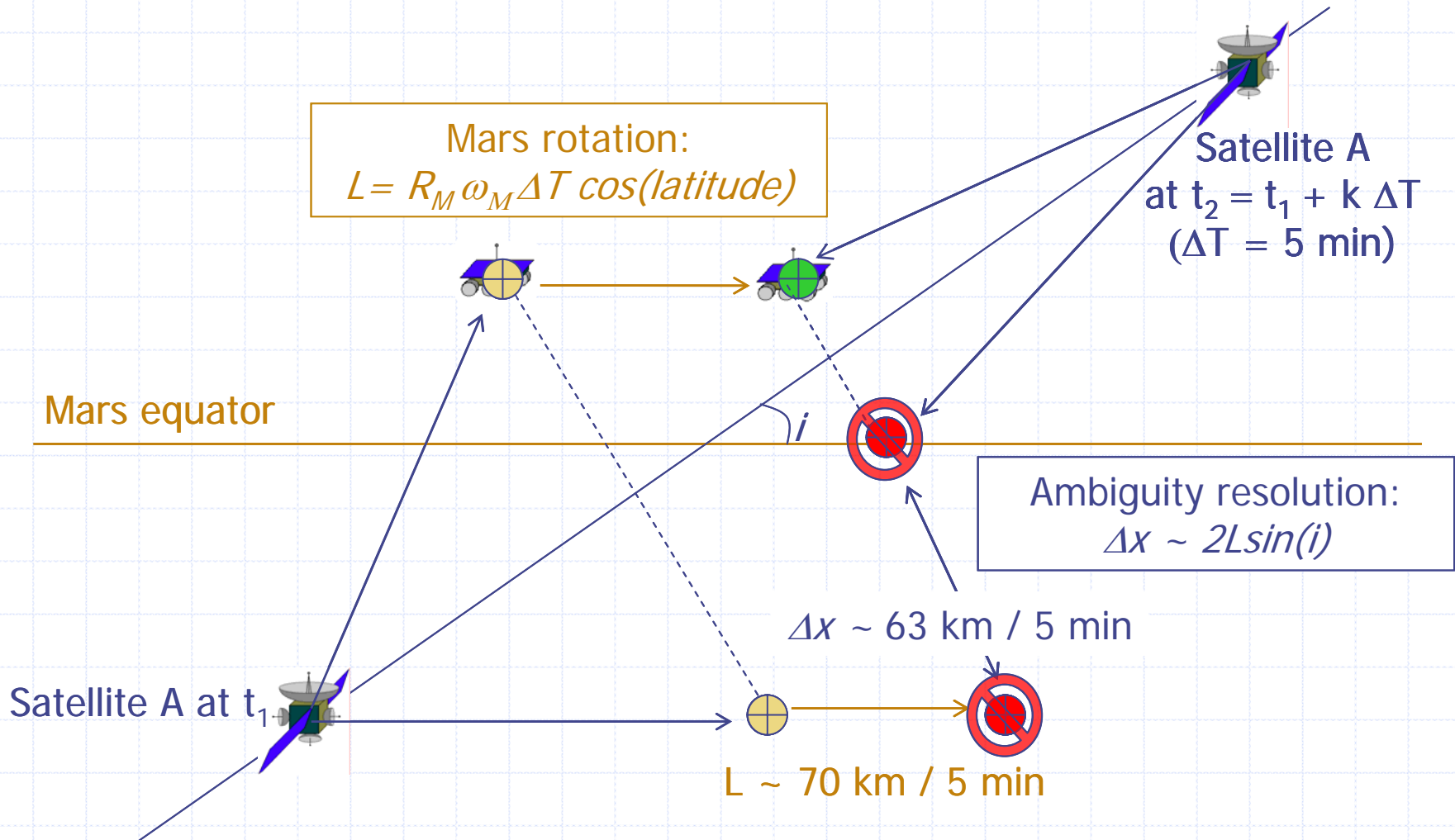

Sources of Error

	Properties	Magnitude	Effect	
Internal	Ranging error	Code chip rate	10 m	Not limiting factor
	Doppler error	Integration time	< 1 cm/s	Not limiting factor
Sat. oscillator stability		< 1 mm/s		
External	MSE altitude	Mars topography	~ 200 m	Corrected with time
	MSE velocity	Assumed very slow Measured with IMUs	< 1 cm/s	4 – 90 km error Per km/hr
	MINERVA orbits	Quick positioning: orbit prediction	100 m – 10 km	Absolute upper bound on accuracy
Post-processing: orbit determination		20 m		

Time to Get 100 m Accuracy

- ◆ Probability to reach 100 m accuracy (1σ) within certain time:

0° latitude

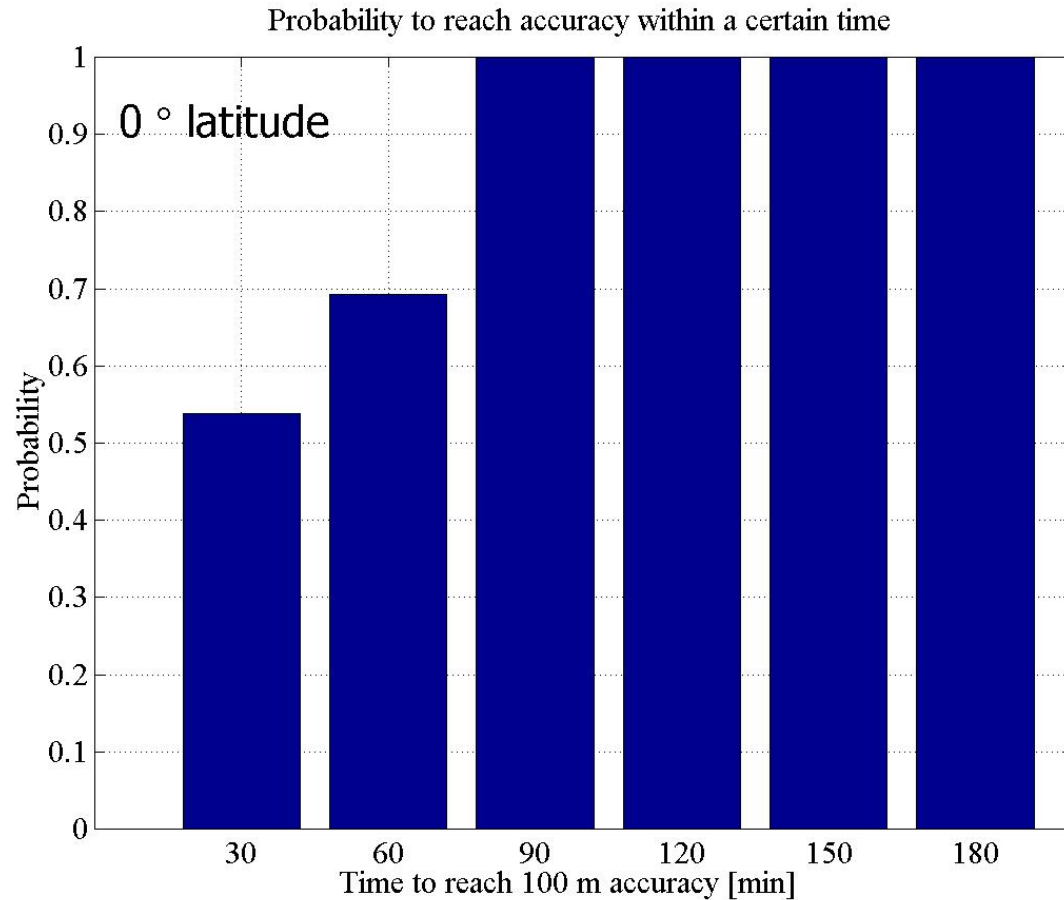

Time to Get 100 m Accuracy

- ◆ Probability to reach 100 m accuracy (1σ) within certain time:

15° latitude

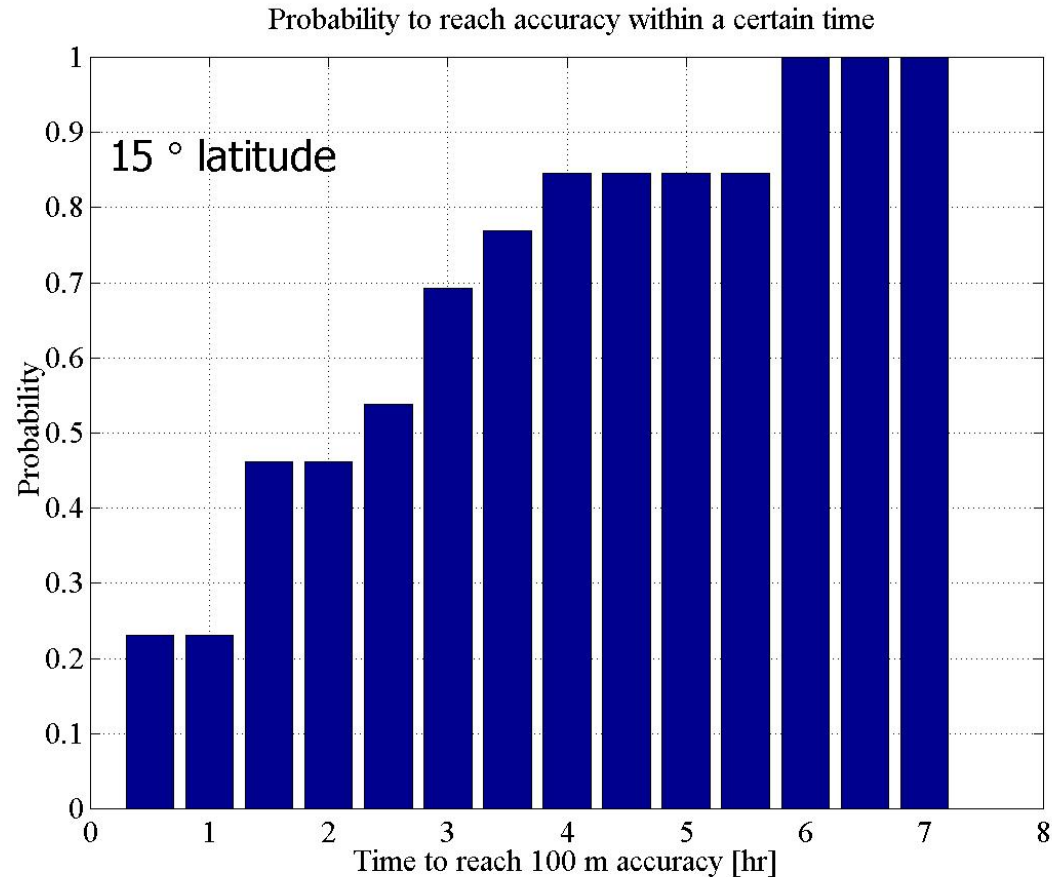



Detailed Design: Software Analysis

MINERVA Software Components

- ◆ Flight software
- ◆ Test, integration, and simulation software
 - Used to verify initial and updated flight software and during anomaly recovery
 - Cost modeled in CERs
- ◆ Operations software
 - Mission & activity planning
 - Mission control
 - Navigation & orbit control
 - Spacecraft operations
 - Data delivery, processing, and archiving

Flight Software

- ◆ "Estimation by similarity" technique used to estimate:
 - Source lines of code (SLOC)
 - Software throughput requirements (MIPS)
 - Software memory requirements (MB)
- ◆ Flight software trades
 - Level of flight software autonomy
 - Programming language: C or Ada

Flight Software Autonomy Trade

Level of Autonomy	MSE Position Determination	Communications	GN&C
High	<ul style="list-style-type: none">◆ Calculated on-board◆ Continuously tracks MSEs	<ul style="list-style-type: none">◆ Automatic communications routing	<ul style="list-style-type: none">◆ High precision orbit propagator◆ Accurate position calculated on-board
Partial	<ul style="list-style-type: none">◆ Calculated on-board with Earth input	<ul style="list-style-type: none">◆ Preplanned communications routing◆ Simple search	<ul style="list-style-type: none">◆ Medium precision orbit propagator◆ Earth provides accurate positions
Low	<ul style="list-style-type: none">◆ Calculated on Earth		

Other Flight Software Autonomy

- ◆ Attitude determination and control
 - Includes momentum management
- ◆ Routine housekeeping
 - Thermal control
 - Power management
 - Data storage
- ◆ System monitoring
 - Detects anomalies
 - Controls safe modes

Flight Software Size

- ◆ Some I/O device handlers can be reused

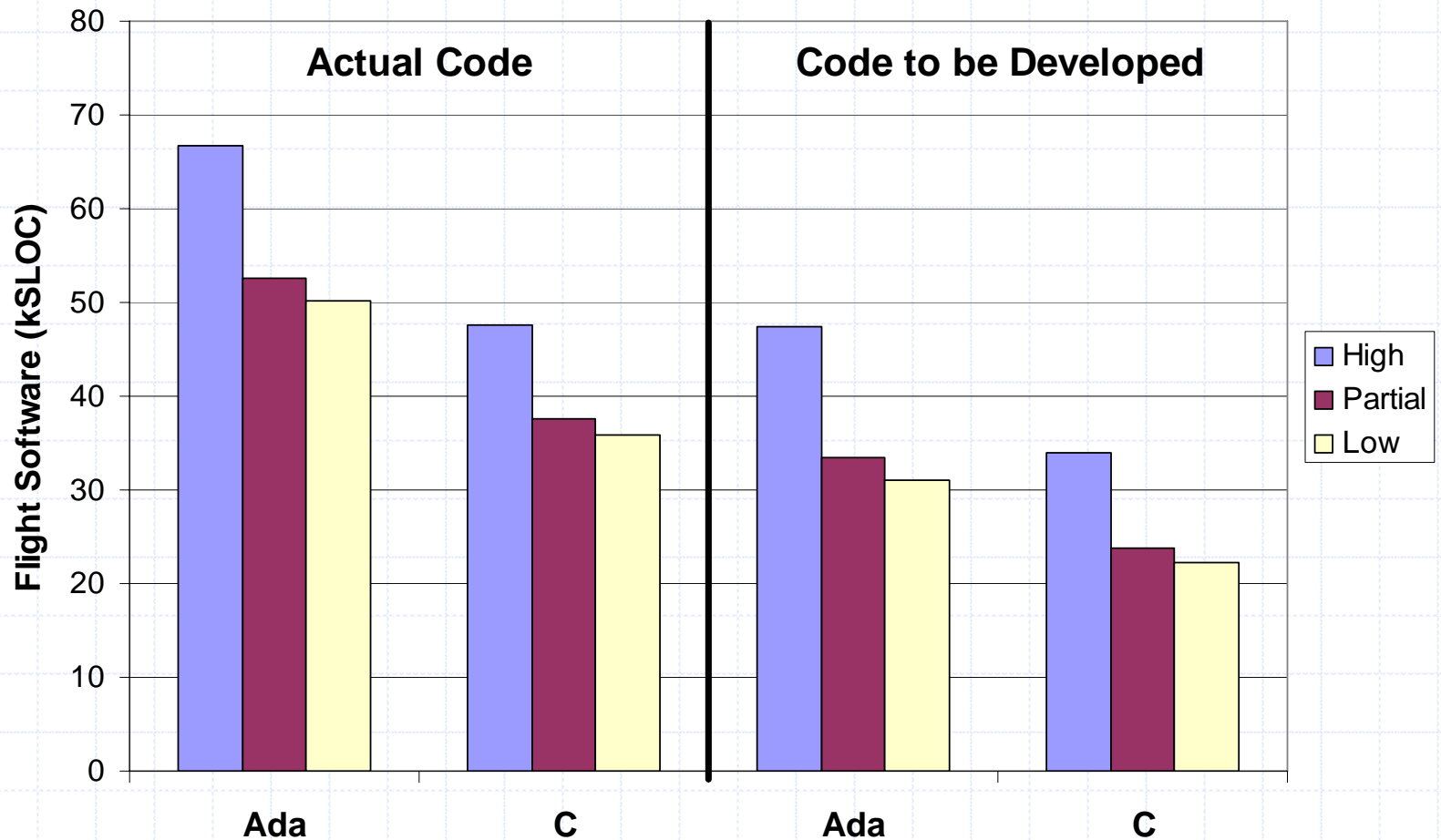

Flight Software Computer Requirements

- ◆ RAD 6000 Provides
 - Throughput: 10 to 20 MIPS
 - Memory: 16 GB
- ◆ Software computer requirements are met

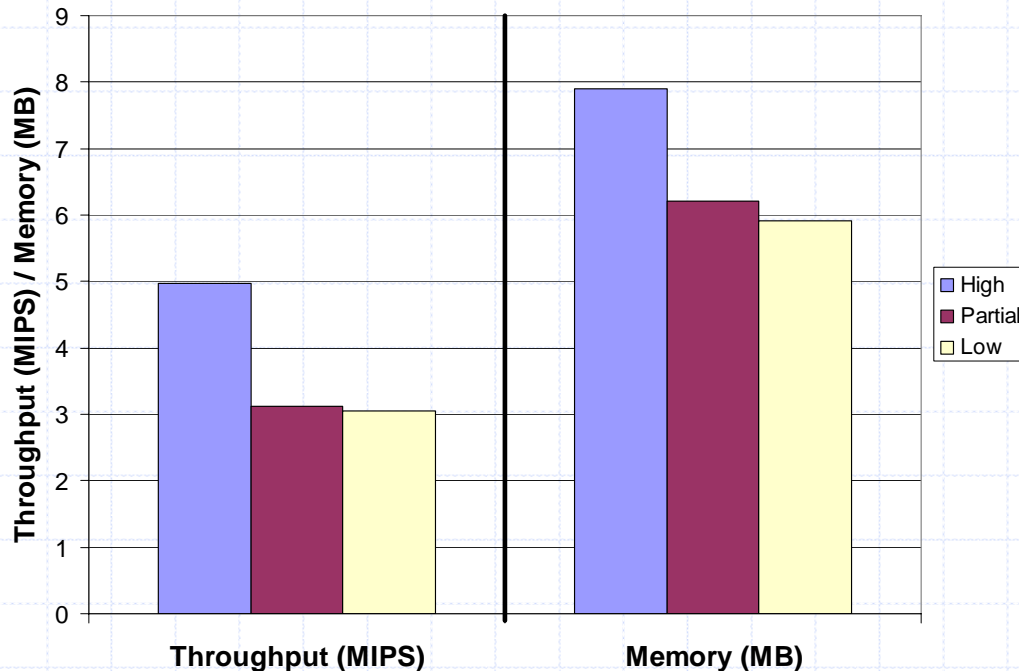

Ground Software Size

- ◆ Test, integration, and simulation software
 - Assumed to be 4x the size of the flight software
 - Modeled in CERs
- ◆ Initial operations software
 - Assumed to be 4x the size of the flight software

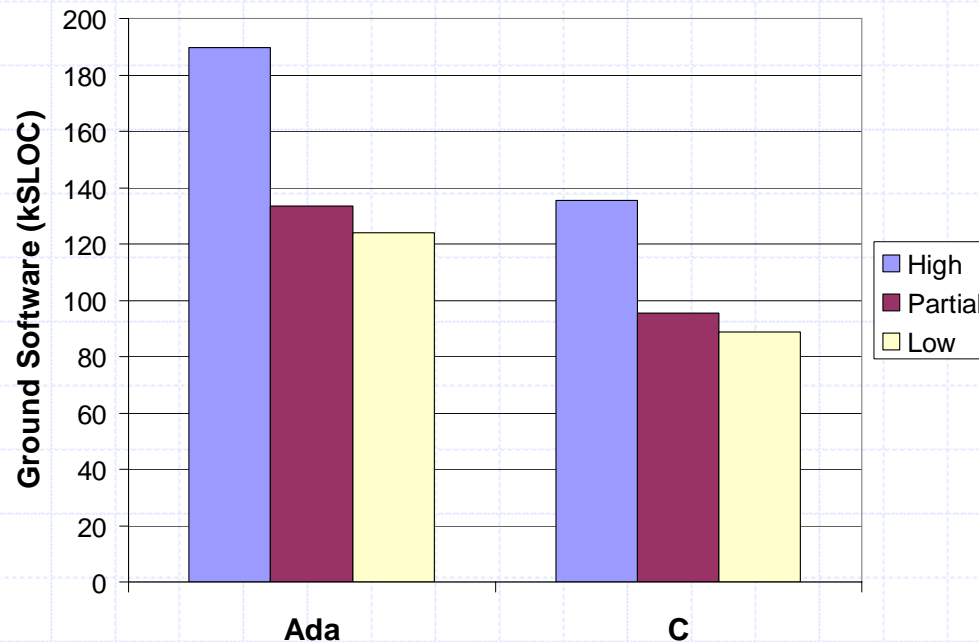

Software Cost

- ◆ Partial autonomy with C as the programming language was chosen to meet IOC cost cap

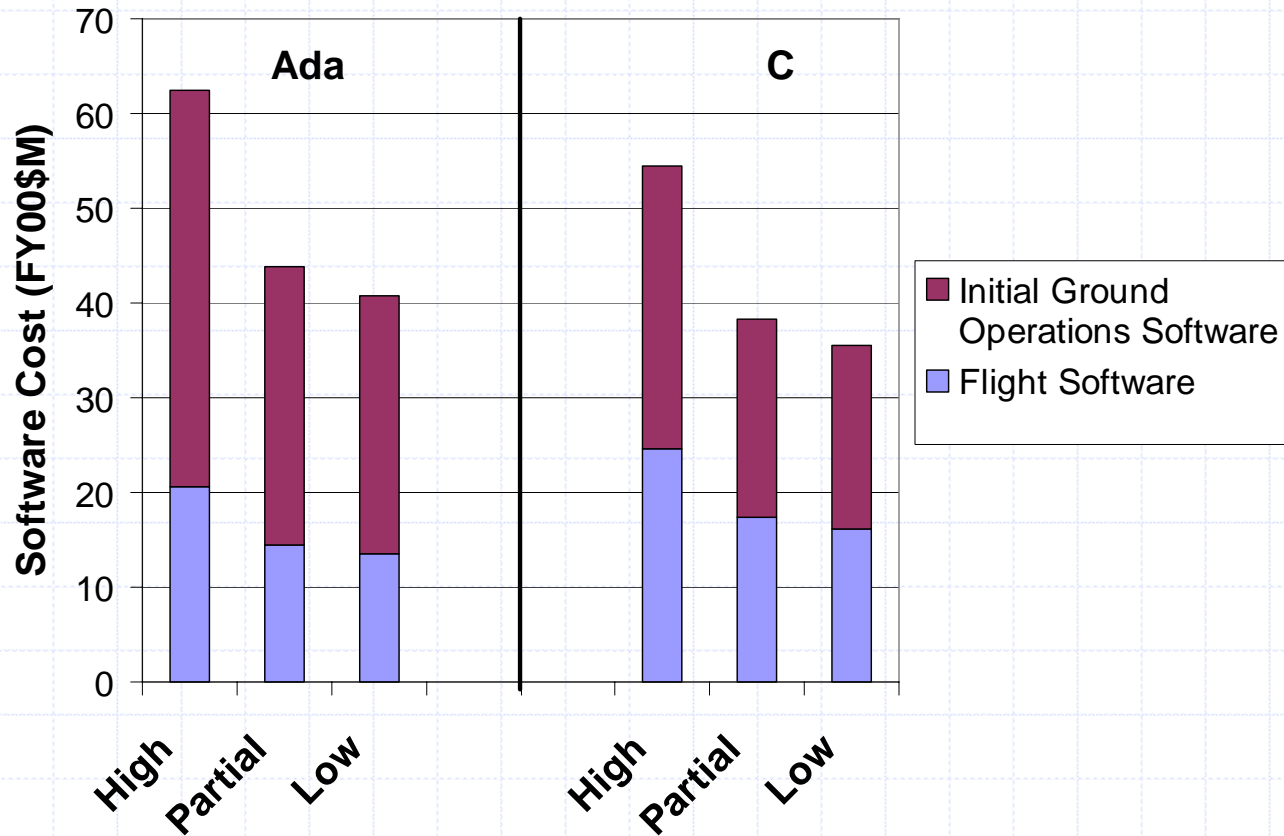

Autonomy vs. Operations Cost

- ◆ Autonomy reduces the yearly operations cost

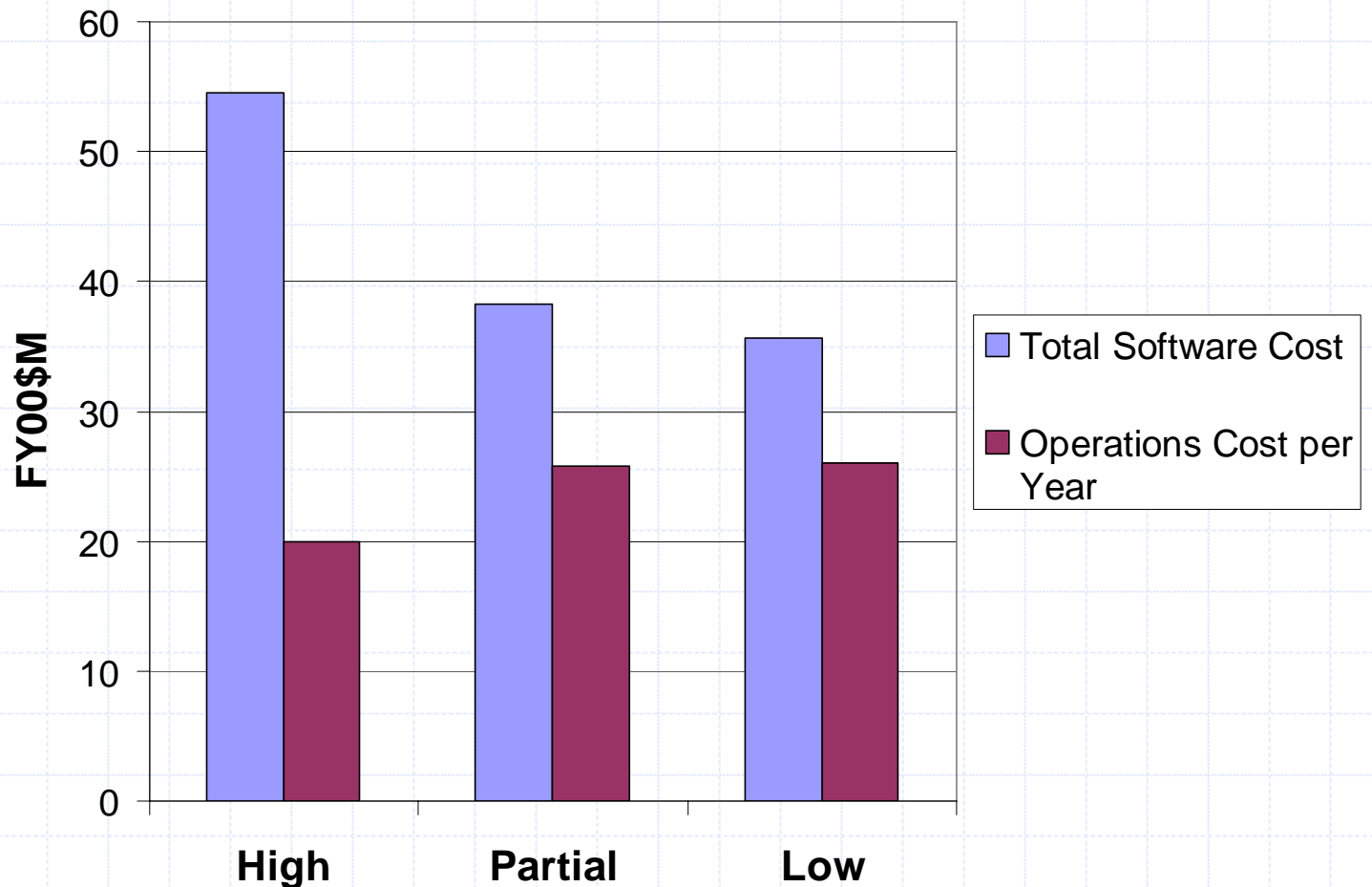

Autonomy vs. Operations Cost

- ◆ High autonomy is cheaper in the long run

Total Software and Operations Cost for Different Autonomy Levels

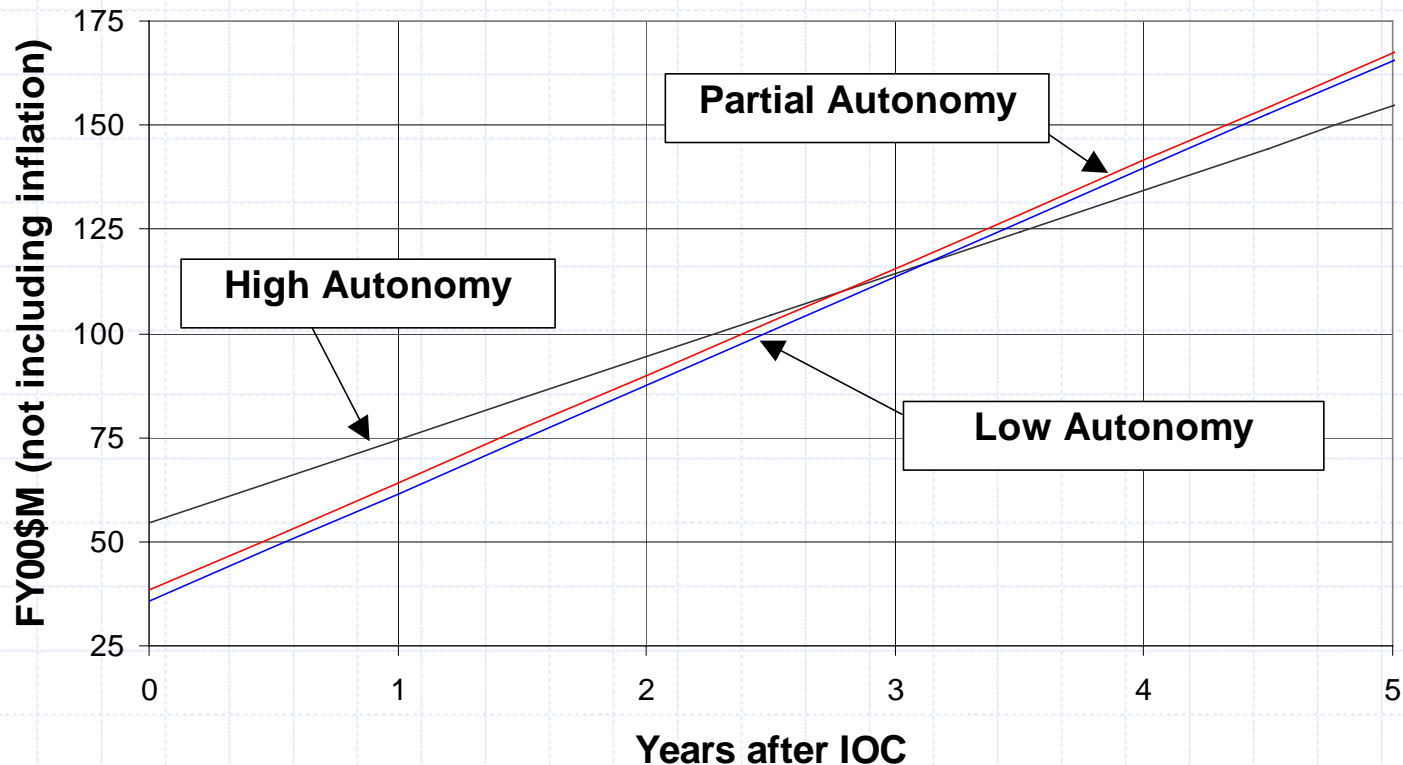



Detailed Design: Bus Analysis

Bus Requirements

- ◆ **M008** MINERVA shall have a design lifetime of at least 6 years.
- ◆ **S002** Each spacecraft shall have power to support nominal operations of the spacecraft at all times, including eclipse periods.
- ◆ **S003** Each spacecraft mass shall not exceed 575 kg.
- ◆ **S011** Each spacecraft shall have the capability to boost to a disposal orbit.
- ◆ **B001** ADCS subsystem shall maintain pointing accuracy of 0.1 degree.

Bus Requirements

- ◆ **B002** ADCS shall provide orbit station keeping.
- ◆ **B003** Thermal subsystem shall maintain spacecraft components within their operating temperature ranges.
- ◆ **B004** Power subsystem shall provide 200 W of power during transit.
- ◆ **B005** Power subsystem shall provide 400 W of power throughout the operational lifetime in Mars orbit.
- ◆ **B006** Power subsystem shall provide 400 W-hr of energy storage.

Bus Requirements (cont.)

- ◆ **B007** Propulsion subsystem shall provide at least 2400 m/s ΔV (total).
- ◆ **B008** Propulsion subsystem shall provide sufficient ΔV for disposal.
- ◆ **B009** Spacecraft structure shall survive launch environment for a Delta III.
- ◆ **B010** Spacecraft structure shall survive radiation environment for the duration of the mission lifetime.

Bus Group Design

- ◆ MATLAB software model used to perform design trades
- ◆ Inputs
 - Payload characteristics
 - Orbit parameters
 - Mission requirements
- ◆ Outputs
 - Spacecraft budgets
 - Spacecraft cost

ADCS Sub-System Design

- ◆ Directed antenna requires 3-axis pointing stabilization
 - Gravity gradient/spin stabilized could not meet minimum requirements
- ◆ Sensors
 - Sun
 - Horizon
 - Gyros (safe mode)
 - Accelerometers
- ◆ Controllers
 - Reaction wheels
 - Thrusters

Propulsion Sub-System Design

- ◆ Launch decision allows Mars transfer ΔV to be done by launch vehicle
- ◆ Minimize cost - choose between EP, chemical propulsion
- ◆ NTO/MMH propellant
 - $I_{sp} = 322.5$ sec
 - Thrust = 4250 N

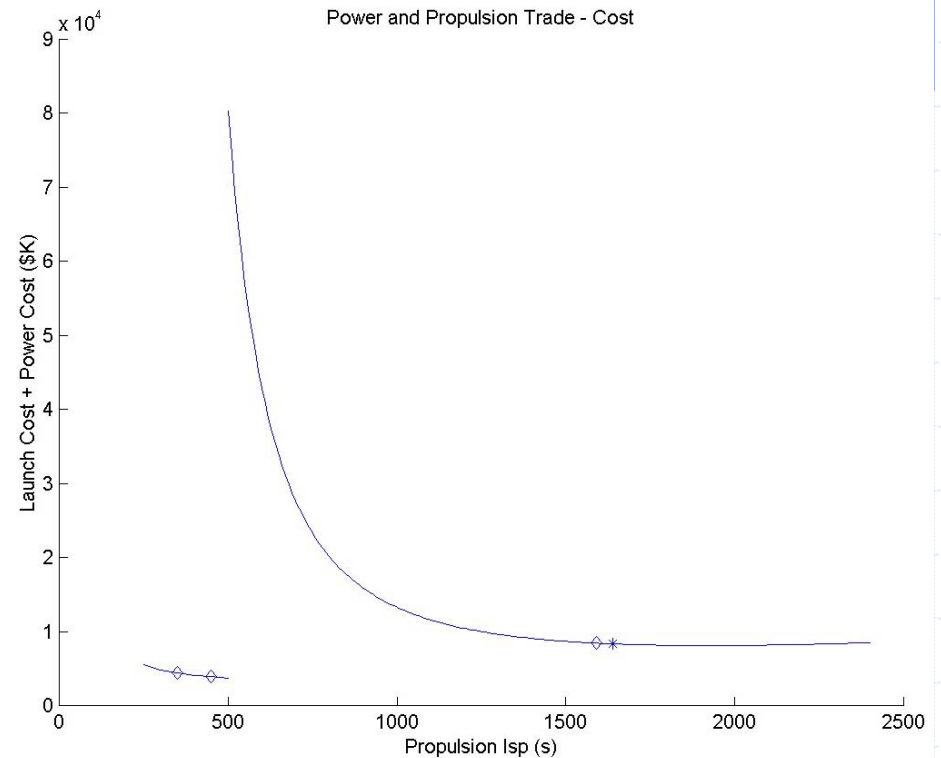

Thermal/Power Sub-System Design

- ◆ Thermal module calculates the power needed to maintain thermal management
- ◆ Power module calculates solar array area/mass based on EOL
 - Solar Array Flight Experiment
- ◆ Batteries sized for mission life, eclipse period
 - Lithium-ion batteries

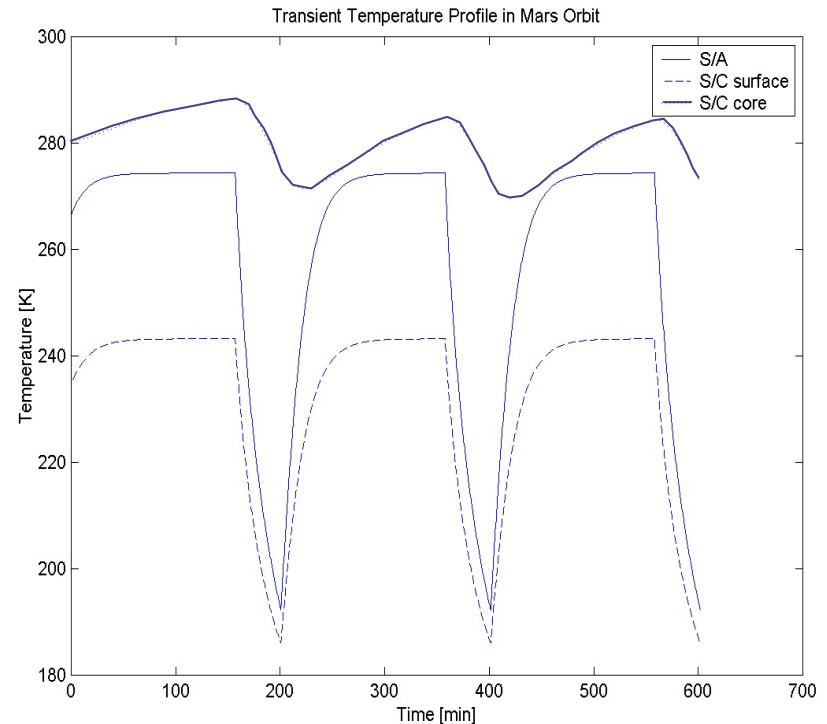

Structure Sub-System Design

- ◆ 15% mass margin
- ◆ 20% structure mass factor
 - Power uses 30%
- ◆ Payload mass calculated separately

Payload Masses
< 1%

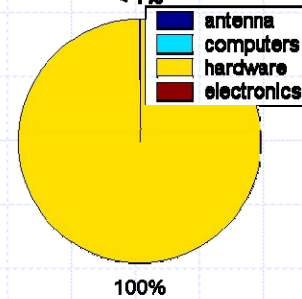

Propulsion Masses

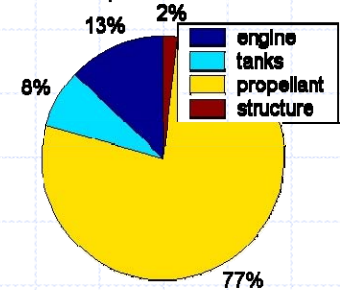

Power Masses

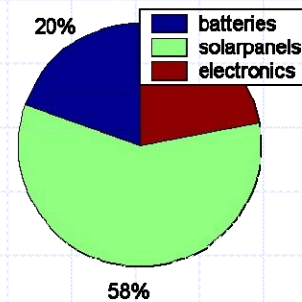

ADCS-Thermal Masses

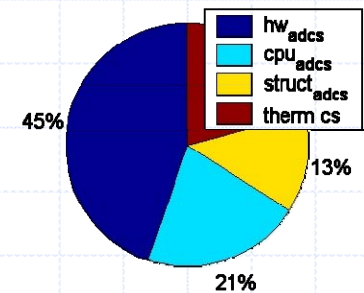

Subsystem Masses

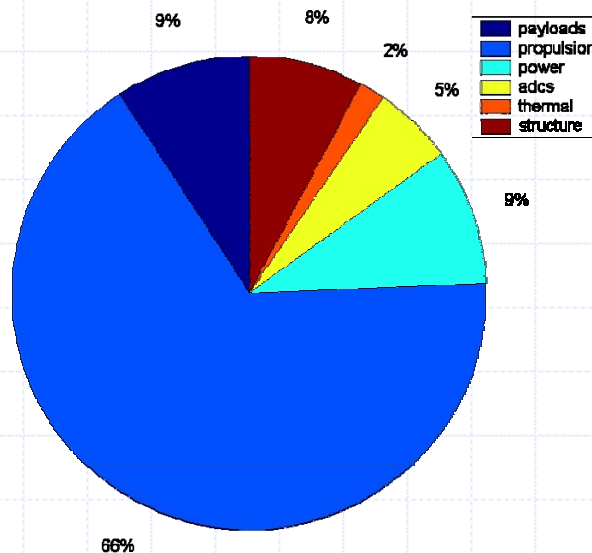

Spacecraft Bus Design

System Component	Number	Mass	Total Mass	Total Power	Critical Dim
Payload	1	37	37	190	Ant Diam = 2m
ADCS			30.7	39.0	
Sun sensor	6	1.2	7.0	0.8	
Horizon Sensor	4	0.7	2.8	5.0	
Gyroscope	2	0.7	1.3	10.0	
Accelerometer	2	0.1	0.2	1.2	
Reaction Wheel	4	3.8	15.0	22.0	
Structure	-	4.4	4.4	-	
Propulsion			273.8	25.0	
Propellant	-	177.4	211.8	-	
Main Engine	1	4.5	4.5	15.0	
ACS Engine	12	0.5	6.0	-	
Propellant Tank	2	10.6	21.2	-	Diameter = 0.6m
Blow down System	1	20.0	20.0	-	
Feed System	-	5.0	5.0	10.0	
Structure	-	4.4	5.3	-	
Thermal			7.0	11.6	
Heater	-	2.3	2.3	11.6	
Radiator	-	2.3	2.3	-	
Insulator	-	2.3	2.3	-	
Power			50.1	418.0	
Solar Arrays	2	11.0	22.0	418.0	Area = 4.00 m ²
Electronics	-	8.3	8.3	-	
Batteries	6	1.2	7.4	393 W-hrs	
Wiring	-	1.0	1.0	-	
Structure	-	11.3	11.3	-	
Launch Structure	-	10.5	10.5	-	
Total Mass:			409		
w / margin			470		

Launch Vehicle Fit-Check

- ◆ Four satellites fit in Delta-III fairing with 3 cm minimal clearance
- ◆ Bottom satellite mounts to launch vehicle adapter structure
- ◆ Satellite attachment rings part of satellite structure
 - Pyro-bolts lock rings together
 - Springs separate spacecraft after rings unlock

Stowed Satellite

- ◆ Stowed volume
~ 4 m³

Spacecraft: Nadir Pointing Side

- ◆ Helix antenna
- ◆ Horizon sensors
- ◆ Primary sun sensors
- ◆ Sun-nadir steering
maintains Mars-Earth-
Sun pointing
 - Steerable main antenna
 - Steerable solar arrays

Satellite: Internal Components

- ◆ First iteration of ADCS and electronics layout
- ◆ Propellant tanks shown:
 - NTO/MMH
 - He pressure regulation
- ◆ Lithium/Ion batteries
 - 2 are redundant
 - Hidden in diagram
- ◆ Harnessing and plumbing not modeled

Image removed due to copyright restrictions.



Detailed Design: Operations Analysis

Operations Requirements

- ◆ **Z002** System shall have an operational lifetime of at least 5 years.
- ◆ **M006** At IOC the system shall be able to support at least 10 MSEs simultaneously.
- ◆ **S005** Constellation shall have at least 90% probability of meeting the minimum requirements throughout its operational lifetime.
- ◆ **S010** Each spacecraft shall have at least one recoverable safe mode.

Operations: System Context

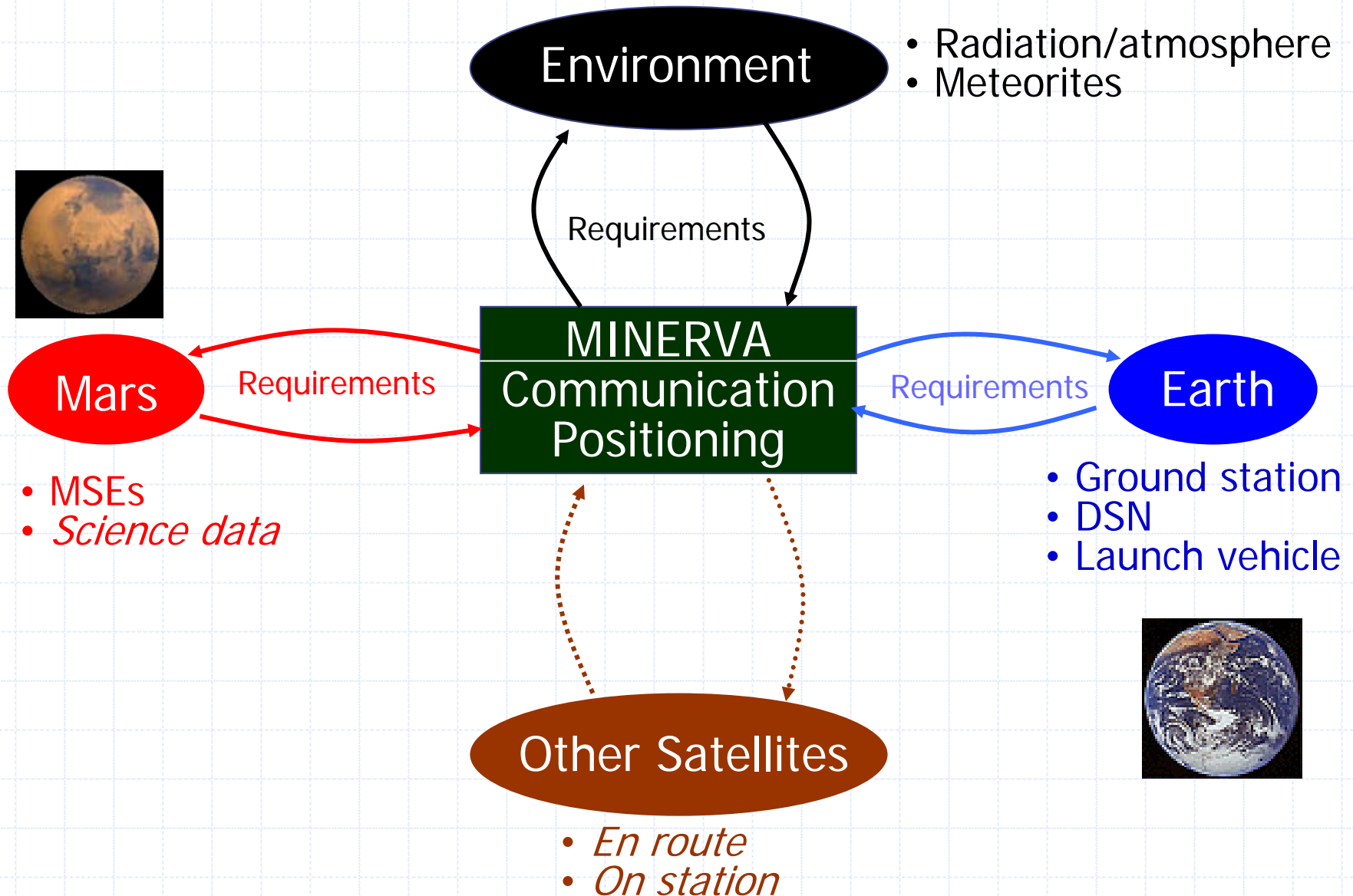

Operations: Functional Analysis

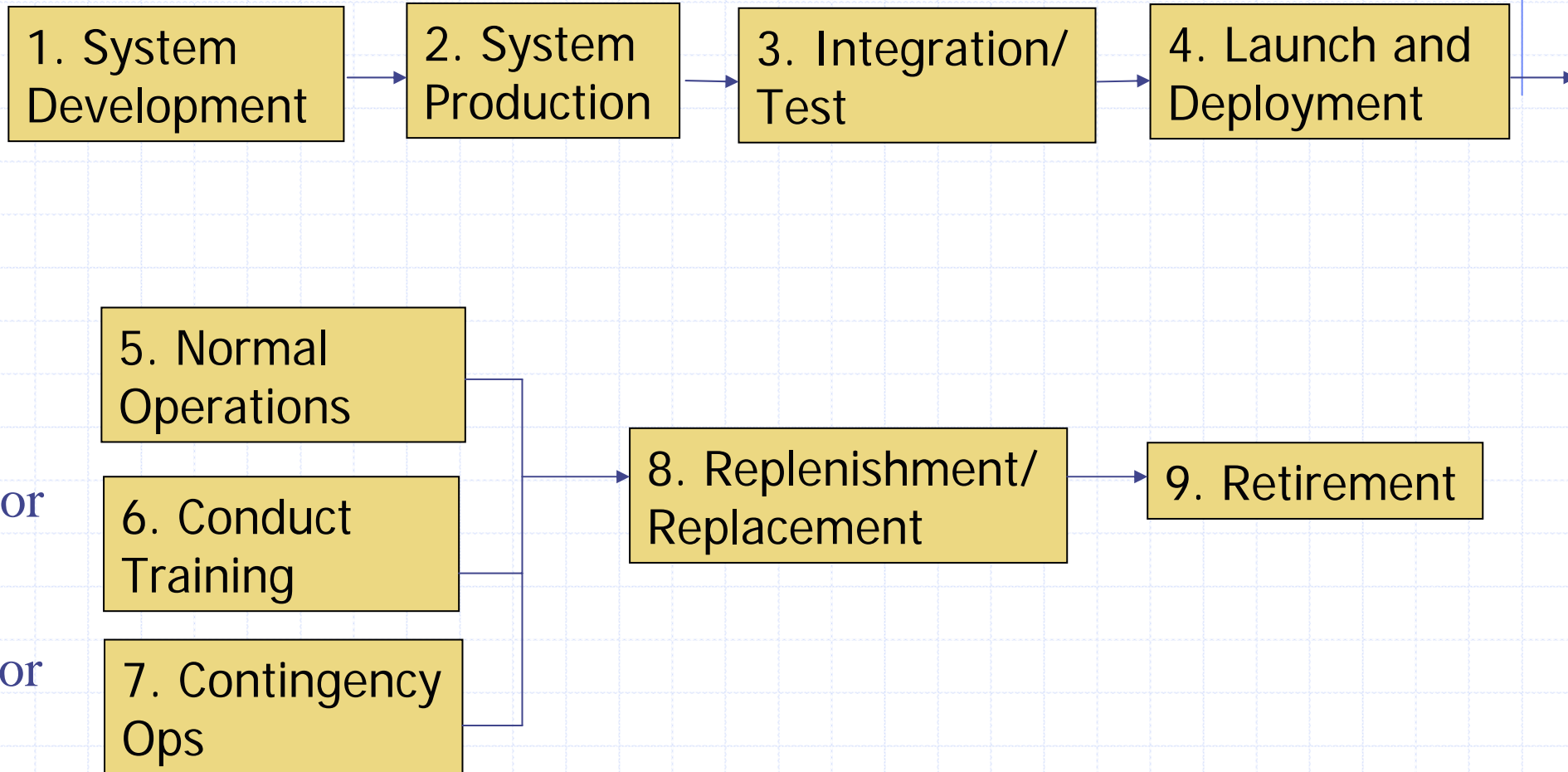

Operations: Functional Analysis

- ◆ Earth Uplink
 - Data collection/processing at EGS
 - Segments are time/destination tagged
- ◆ Mars Uplink
 - MINERVA initiates communication per instructions
- ◆ Positioning Loop
 - MINERVA initiates positioning
 - On-board calculation with EGS updates
- ◆ Anomaly Resolution
 - Three Safe Modes, Tiger Team crisis resolution

System Reliability: Safe Modes

- ◆ Progressive levels of ops reduction
- ◆ Graceful degradation of spacecraft and availability
- ◆ **Safe Mode 1:** Anomaly flags or checkouts not ok, maintain high availability
- ◆ **Safe Mode 2:** Non-critical power or mechanical failures, EGS notification
- ◆ **Safe Mode 3:** Critical failure, spacecraft shutdown, 14 hour self-reliance window

System Reliability: Failure Tree

- ◆ Examination of critical failures
 - Result from lower level faults
 - Multi-path vs. complete redundancy
- ◆ Setup Phase
 - Binary: Launch, separation, transit
 - Partial: Detachment, deployment, capture
- ◆ Normal Operations Phase
 - No failure
 - External: Environment, interactions
 - Internal: Operators, software, hardware

System Reliability: Event Analysis

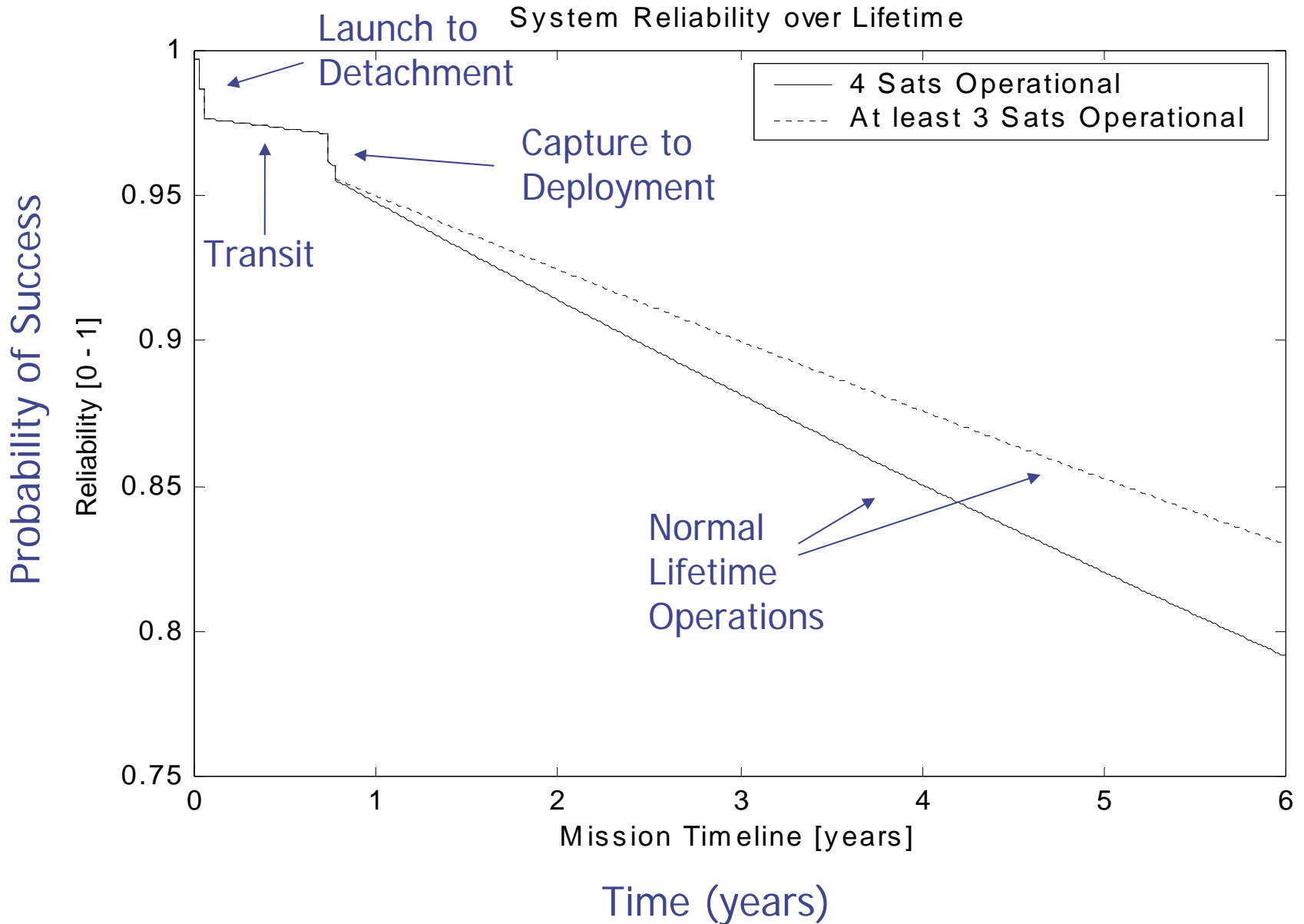



Detailed Design: Launch Analysis

Launch Requirements

- ◆ **Z001** System shall achieve initial operational capability by 2010.
- ◆ **M007** Total system mass and supporting launch structure shall be no greater than what can be launched on a single launch vehicle to a Mars transfer orbit.
- ◆ **S009** Launch vehicle shall be able to boost entire constellation mass to a Mars transfer orbit with a C3 energy of $6.46 \text{ km}^2/\text{s}^2$.

Launch Vehicle Trades

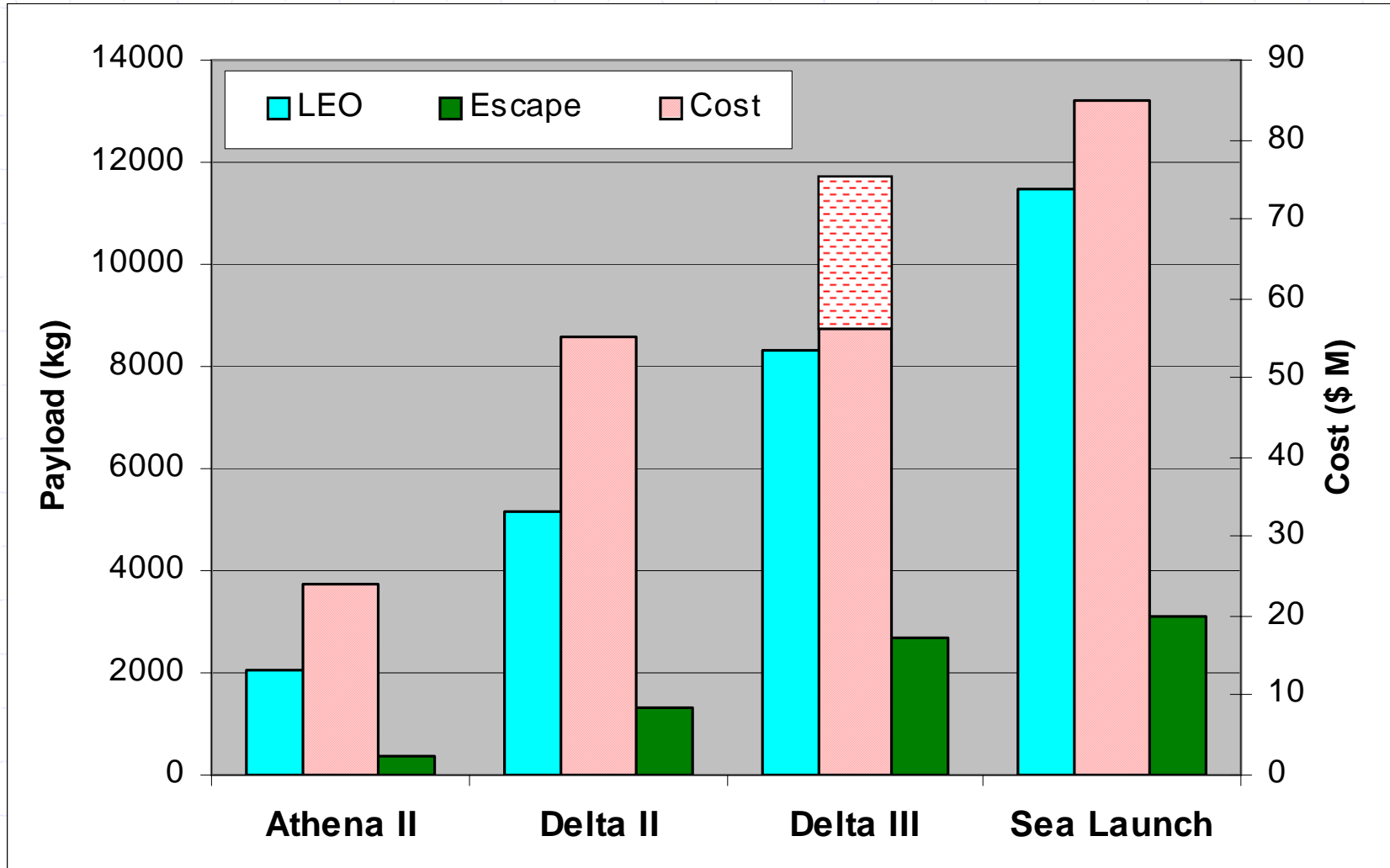

Launch Vehicle Performance

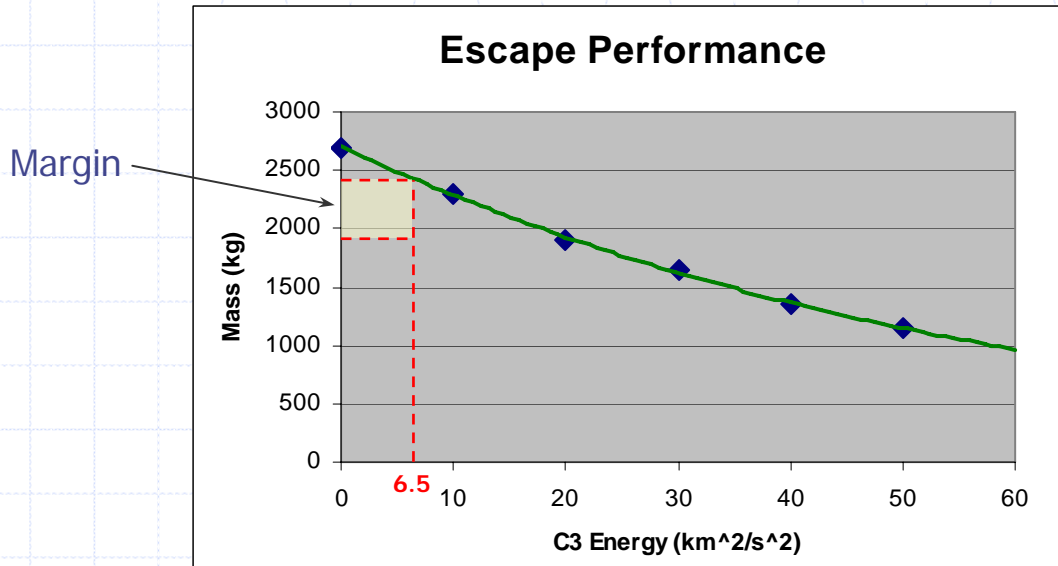

- ◆ The Delta III can provide more C3 energy than is needed for transfer
- ◆ Additional capability will be used to change the inclination of the parking orbit to 23.45°



Detailed Design: Cost Analysis

Cost Requirements

- ◆ **Z003** At IOC the expenditures in FY2000 dollars shall be less than \$300 million.

Cost Methodology

- ◆ Concurrent engineering sessions calculated total program cost for each design iteration
- ◆ Spacecraft development (10% profit, 15% margin)
 - Design-based cost estimating relationships (CERs)*
 - Limitation: Accuracy of CER methodology
- ◆ Ground station development (10% profit, 15% margin)
 - Ground software x 1.5 (equipment, management, etc.)
 - Assumption: JPL to provide space, equipment to minimize costs
- ◆ Launch
 - Delta III launch vehicle
 - Assumption: Reduction in Delta III costs with EELV-related efficiencies and market pressures
- ◆ Transit and on-orbit operations are not included

*Applied cost factor of 1.25 (addresses uncertainty in methodology)

Cost and Concurrent Engineering

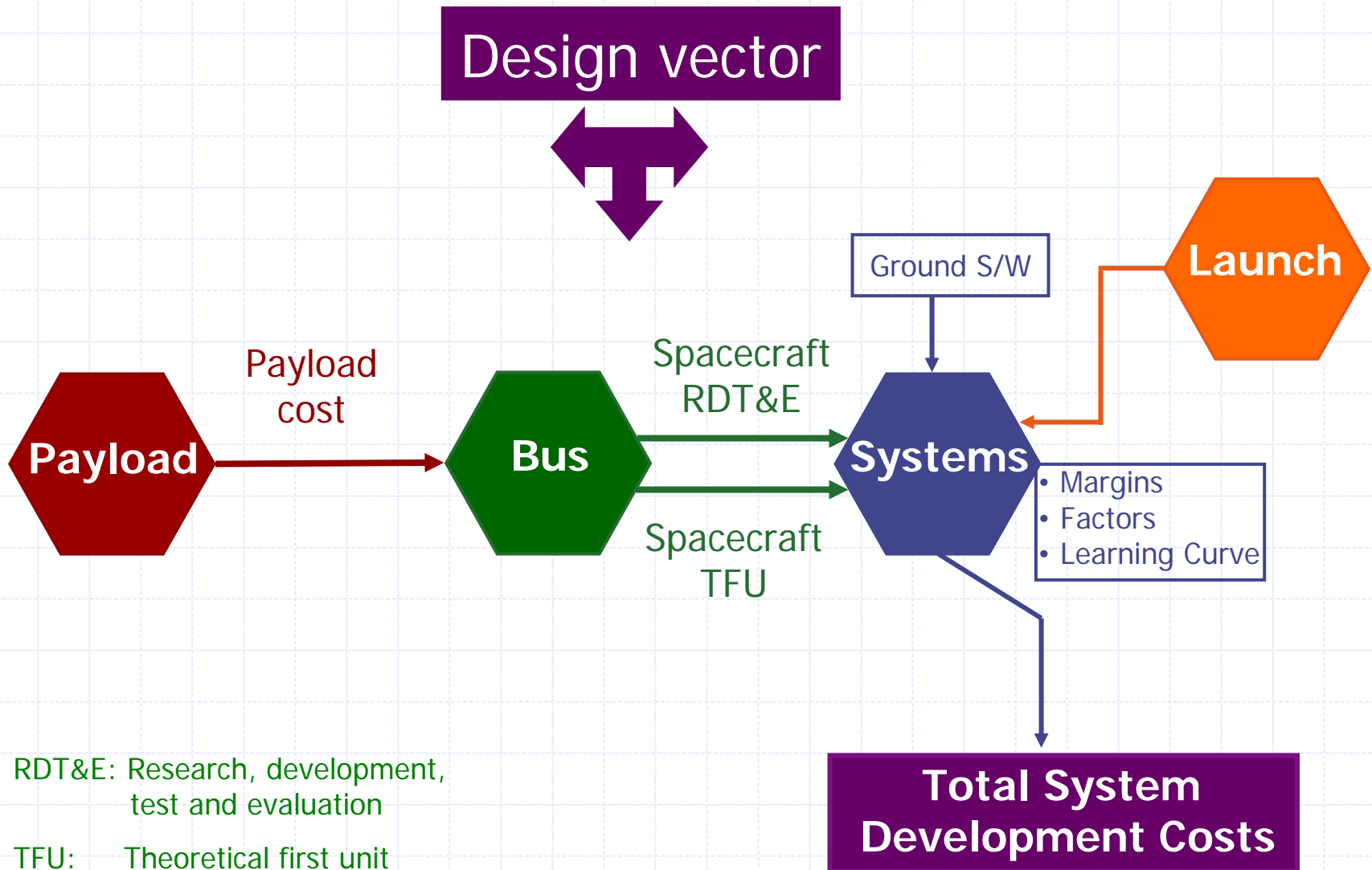

RDT&E: Research, development, test and evaluation

TFU: Theoretical first unit

Major Cost Trades

- ◆ Level of spacecraft autonomy
 - Problem: Spacecraft autonomy drives software costs
 - Trade space
 - ◆ Highly autonomous spacecraft functions
 - ◆ Minimal spacecraft autonomy (on-board position fix or earth position fix)
 - Decision: Minimal autonomy (on-board position fix)
- ◆ Spacecraft propulsion
 - Problem: Determine most cost-effective propulsion system
 - Trade space: Electrical versus chemical propulsion
 - Decision: Chemical propulsion is more cost effective given launch vehicle ability to inject into Mars transfer

Design Freeze Down-Select

	# of S/C	Prop System	Launch Vehicle	Cost (\$M)	Margin* (.15)	Total (\$M)
Option 1	4	EP	Delta III	279.1	33.3	312.3
Option 2	4	Chem	Delta III	266.4	31.5	297.9
Option 3	3*	EP	Delta III	261.2	29.8	290.9
Option 4	3*	Chem	Delta II	244.0	28.2	272.2

* Does not meet all performance requirements (coverage, Gb/sol)

* On spacecraft and ground station development costs. No margin on launch costs.

Spacecraft Cost Model

- ◆ CERs from SMAD
 - Assumes deep space and Earth orbiting systems
 - Accuracy to within 25-50%
- ◆ Calculate RDT&E, TFU cost separately
- ◆ TFU cost scales with number of spacecraft according to learning curve

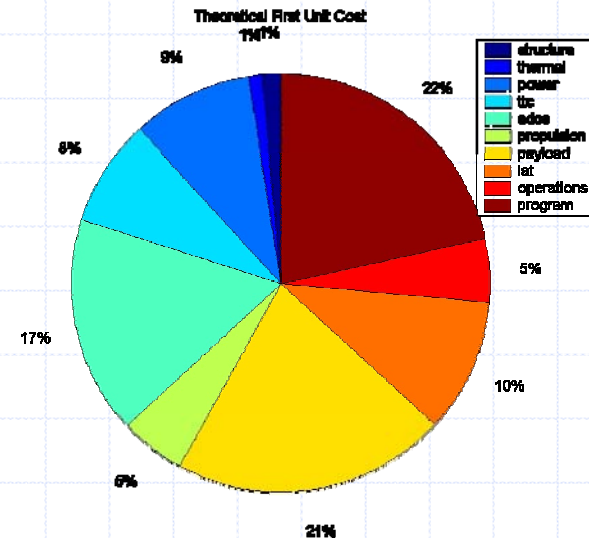
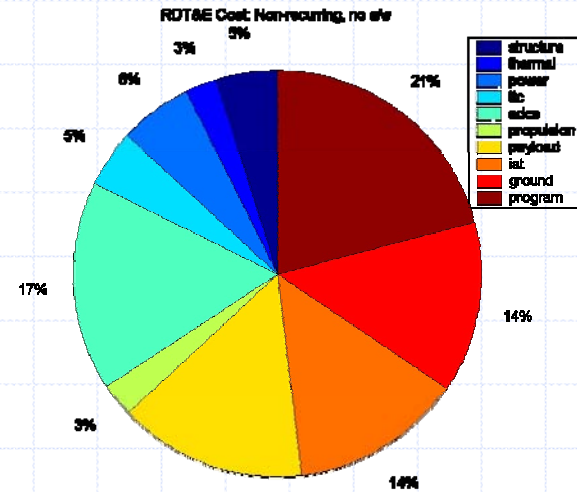

Major Elements of Cost

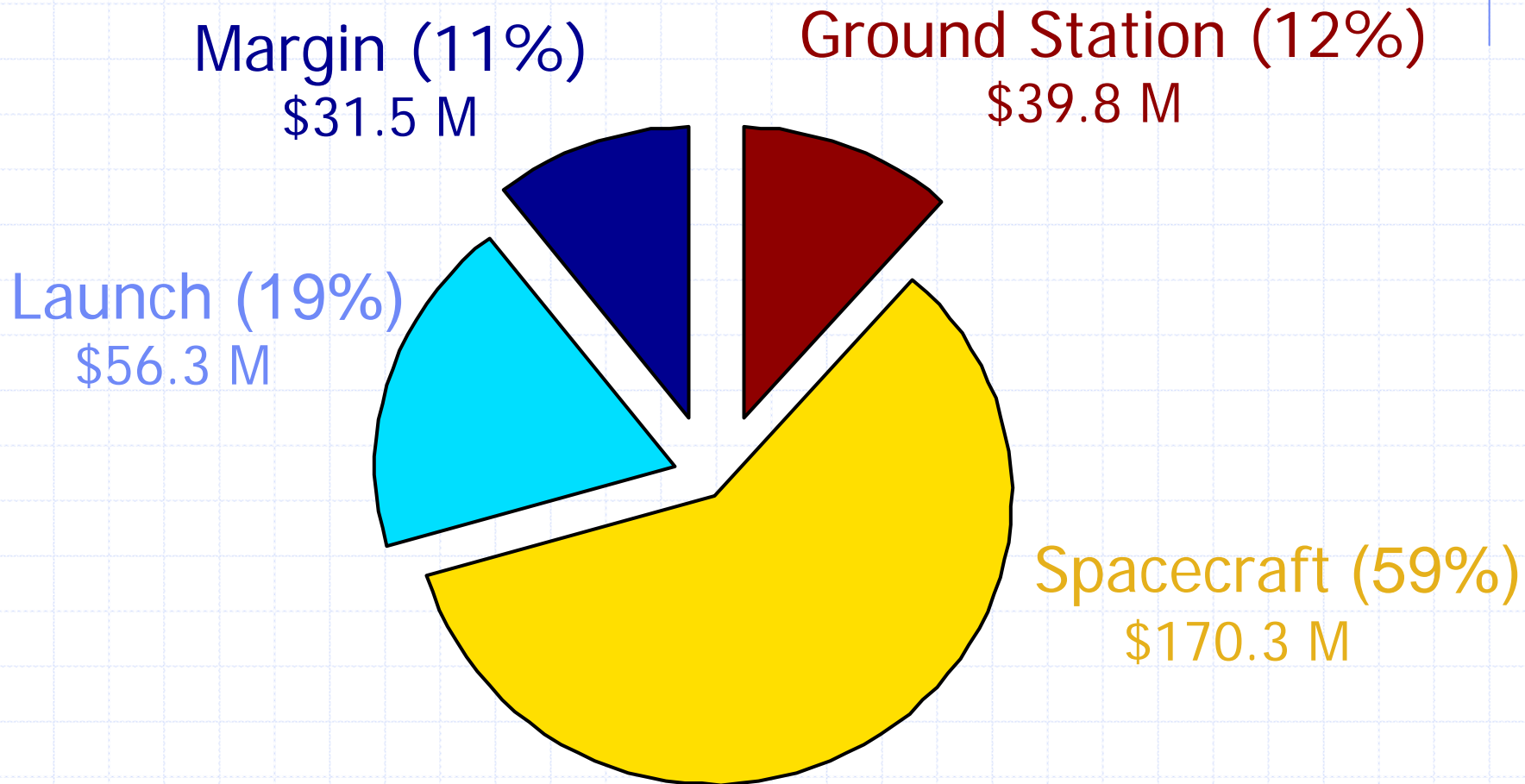

Life Cycle Costs

- ◆ Total Life Cycle Cost (5 year mission): **\$447.1 M**

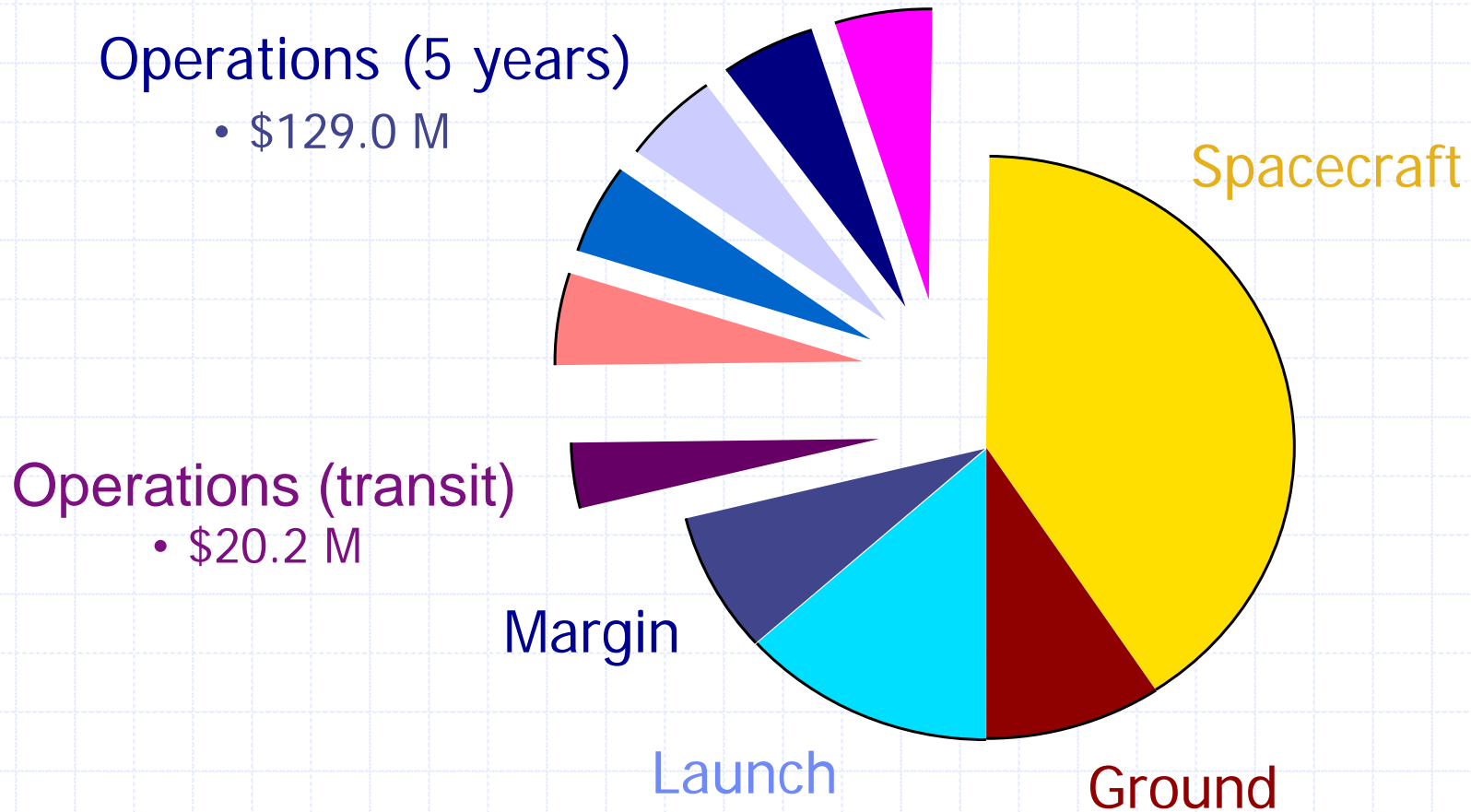



System Level Issues

System-Level Risk Management Strategy

- ◆ Cost Risk (Medium)
 - Source: CER methodology; software & launch costs
 - Strategy: Apply cost factor (1.25) and hold margin (15%)
- ◆ Technical Risk (Low – Medium)
 - Source: Mission integration, software development, cross-links
 - Strategy: Maximize use of proven hardware and software
- ◆ Schedule Risk (Low)
 - Source: Complexity of deep space program
 - Strategy: Hold margin before 2007 launch window

Maintain low risk through cost and schedule management and reliance on existing technology

Program Schedule

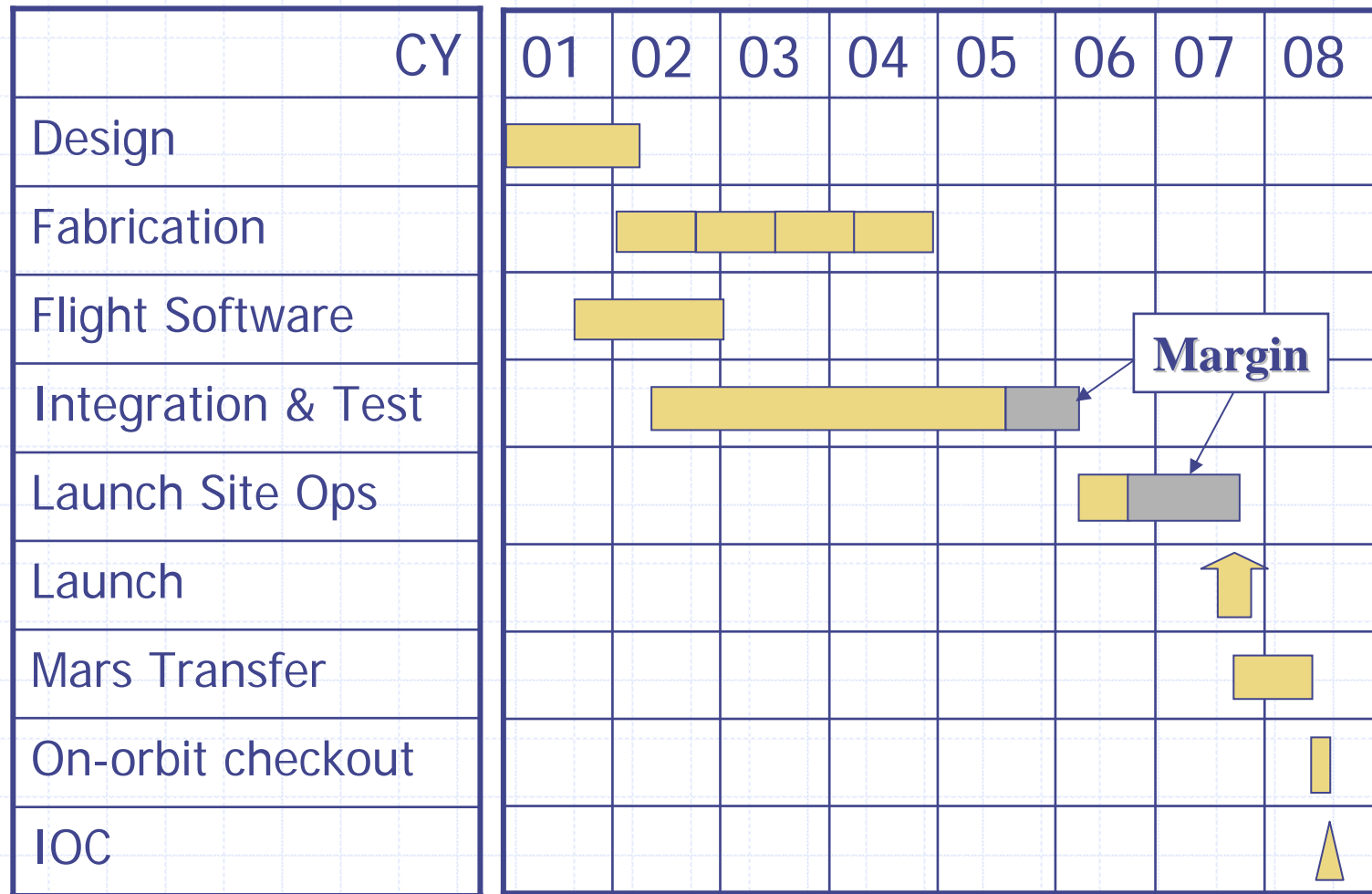

Funding Profile

Total Program Cost: \$297.9 M*

	(CY00 \$M)							
Program Yr	1	2	3	4	5	6	7	8
Calendar Yr	2001	2002	2003	2004	2005	2006	2007	2008
Funding	4.8	26.1	51.1	67.0	67.0	51.1	26.1	4.8

Profile

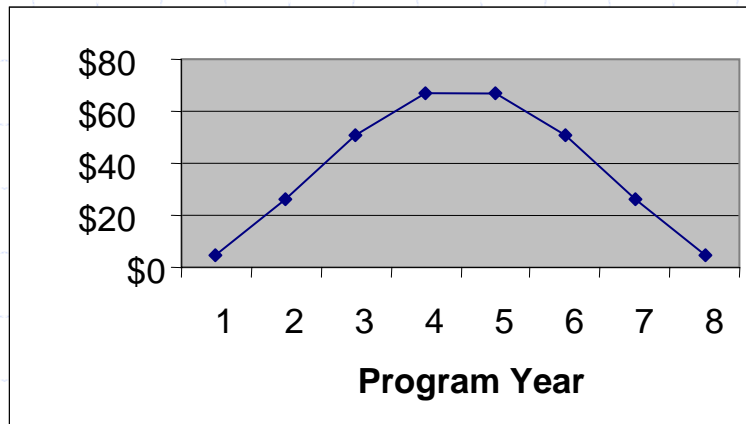

Cumulative

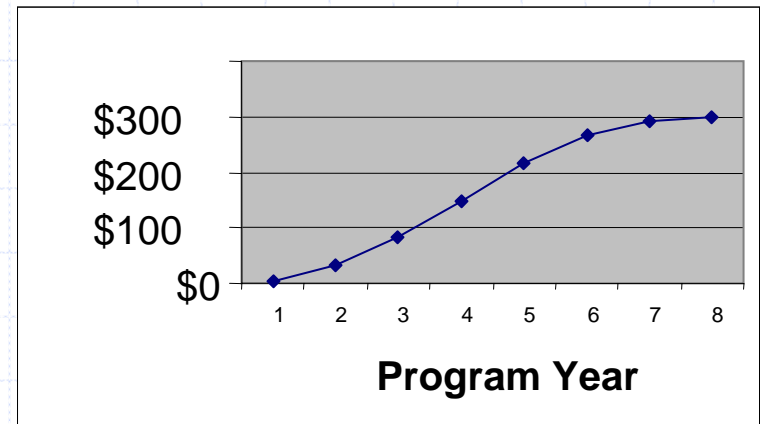

* Includes 15% margin (Note: CER methodology limits validity of cost estimate)

MINERVA Science Capabilities

- ◆ Improve Mars gravity field model
 - Indirect gravitational study of Phobos and Deimos
- ◆ Atmospheric composition of Mars
 - Absorption and scattering properties of Martian atmosphere
- ◆ Radio science
 - Study solar corona and interplanetary medium

Post-IOC System Expandability

- ◆ Upload software with improved autonomy
- ◆ Provide positioning and communication service to other spacecraft
- ◆ Relay between MSEs without Earth interaction
- ◆ Automate ground operations
- ◆ Add more spacecraft to constellation
 - Improve coverage, availability, and reliability
 - Include upgraded capabilities (e.g. remote sensing)
- ◆ Replenish constellation as spacecraft fail

Lessons Learned

- ◆ Methods for discovery of errors and disconnects
 - Usefulness of frequent integration meetings and status briefings
 - Evaluation of concurrent engineering session results
- ◆ Transitions
 - Team structure changed after TARR, delaying some tasks
 - Post-PDR transition much more rapid, effective
- ◆ Concurrent engineering
 - Useful for rapid characterization of design options via real-time inter-team communication
 - Must be supplemented with detailed design analysis between sessions
 - ICEMaker is useful interfacing tool
 - More automation would speed process



Backup Slides





Backup Slides: Orbit Analysis

Transit Overview

Departure burn	18 Aug 07, 09:56
Separation	18 Aug 07, 13:25
Deploy arrays	18 Aug 07, 13:31
Initial checkout	18 Aug 07, 14:00
Exit Earth SOI	21 Aug 07, 02:35
Arrive Mars SOI	29 May 08, 10:56
Circularization	03 Jun 08, 18:18
Deploy antenna	03 Jun 08, 18:20
Test/calibration	09 Jun 08, 22:20
IOC	10 Jul 08, 00:00

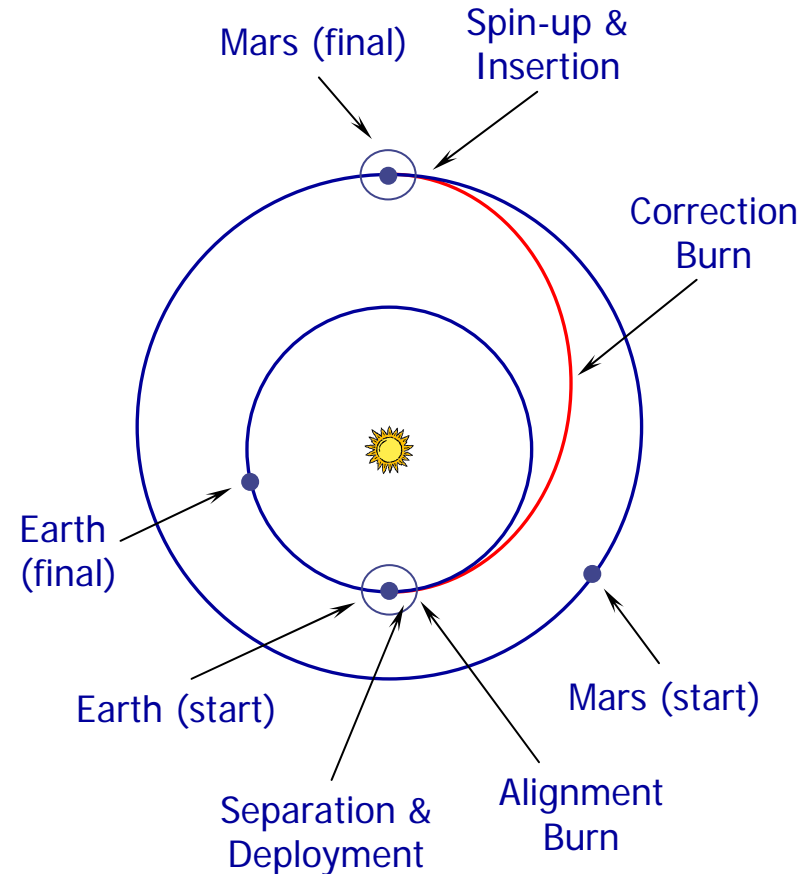

Percentage of Time in View

Single Satellite Failure

- ◆ Constellation provides $>50\%$ coverage in the $\pm 15^\circ$ latitude band
- ◆ Reduced coverage up to $\pm 65^\circ$

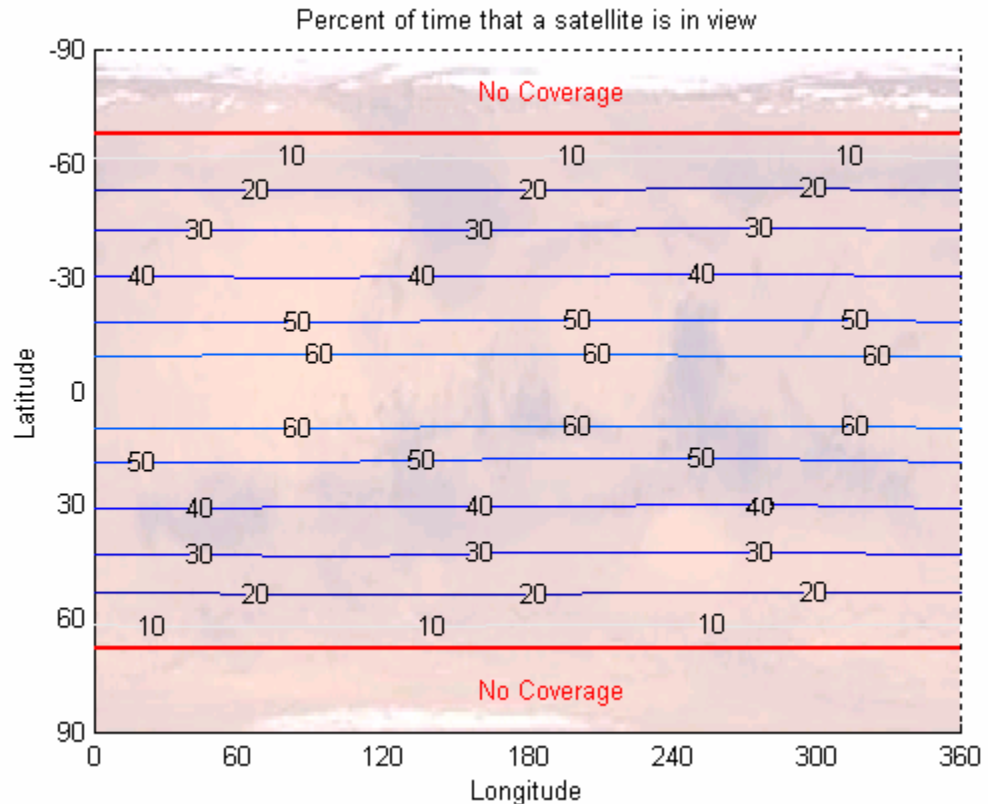

Revisit Time

Single Satellite Failure

- ◆ The maximum time between satellite passes is < 100 min
- ◆ The average time is < 45 min

Maximum Revisit Time in Minutes

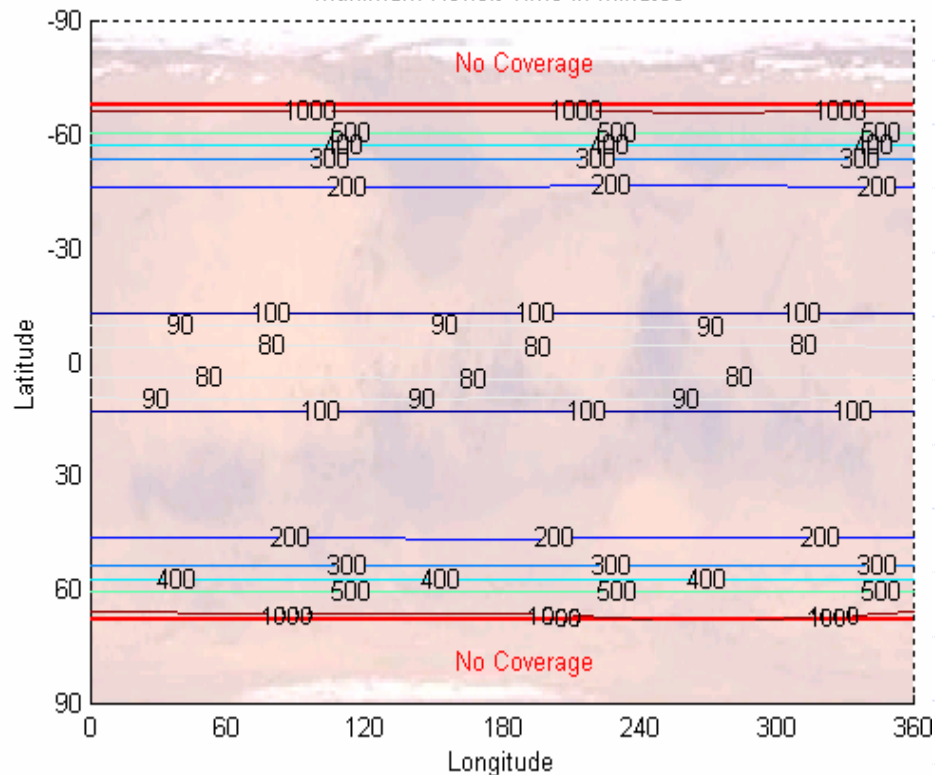

Average Revisit Time in Minutes

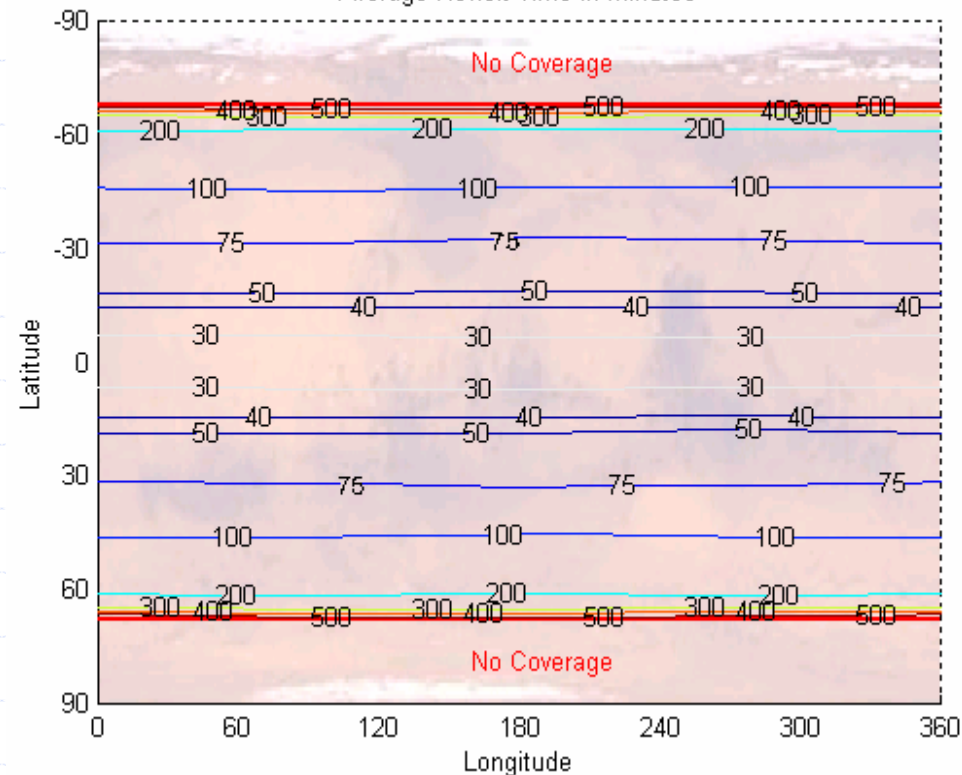

Contact Duration

Single Satellite Failure

- ◆ On average, a satellite will remain in view for 50 minutes.

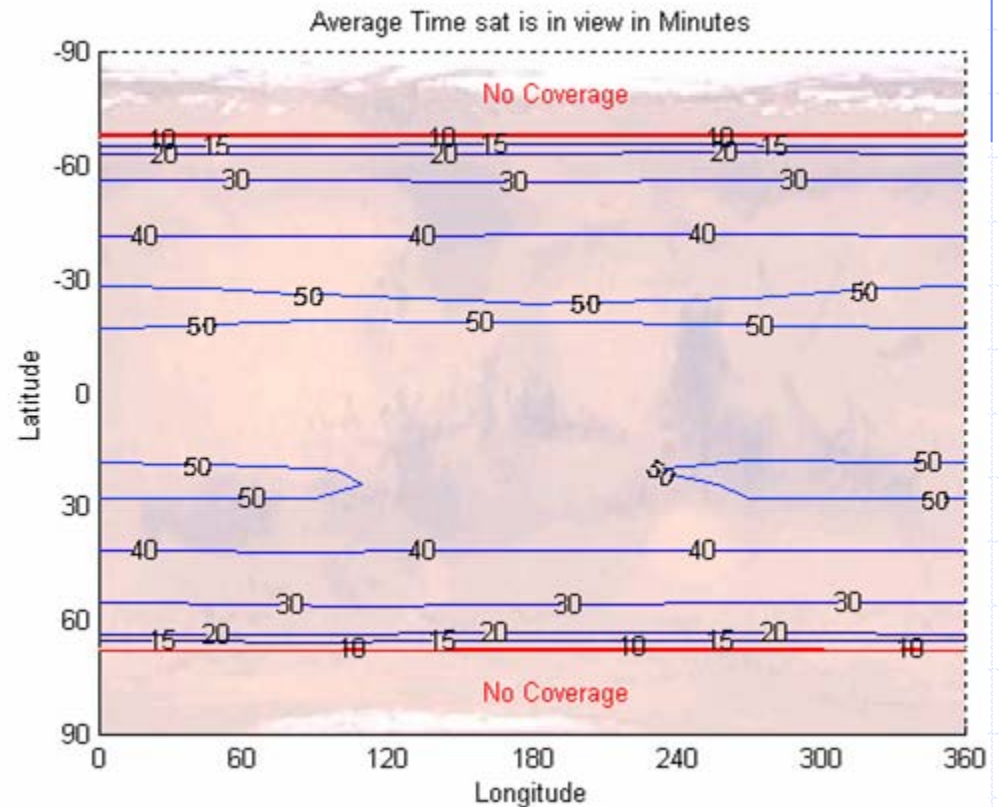



**Backup Slides:
Payload Analysis**

Link Margins

- ◆ Earth - MINERVA link:
 - Uplink: 28.8 dB, downlink: 3.09 dB
- ◆ MINERVA - Mars link:
 - Uplink: 5.29 dB, downlink: 4.73 dB
- ◆ MINERVA cross-link:
 - Uplink and Downlink: 17.4 dB
- ◆ MINERVA cross-link with Ka-band for DTE link:
 - Uplink: 16.65 dB, downlink: 2.97 dB
- ◆ MINERVA cross-link with omni-directional antenna for case of the loss of attitude control:
 - Uplink and Downlink: 12.4 dB

Communications Analysis: Worst Case

- ◆ Two MSEs on the dark side of Mars.
- ◆ Each of the MSEs is at the edge of the cone of MINERVA-Mars link.
- ◆ Each MSE has no more than 10W RF power.
- ◆ Largest distance between Earth and Mars is equal to 401,300,000 km.
- ◆ Maximum distance between MINERVA satellites is equal to 7,633 km.

Payload Electronics Hardware

- ◆ 3 amplifiers (total output power ≈ 165 W)
- ◆ 2 Ka-band and X-band supporting transponders
- ◆ 2 computers
- ◆ 1 UHF transceiver
- ◆ One ultra-stable oscillator

One failure of a critical component
(amplifier, transponder, computer)

≠

loss of the satellite

Frequency Used For Future Mars Missions (from Chad Edwards speech)



Planning View of '04 Mars Relay & Orbital Communication Architecture

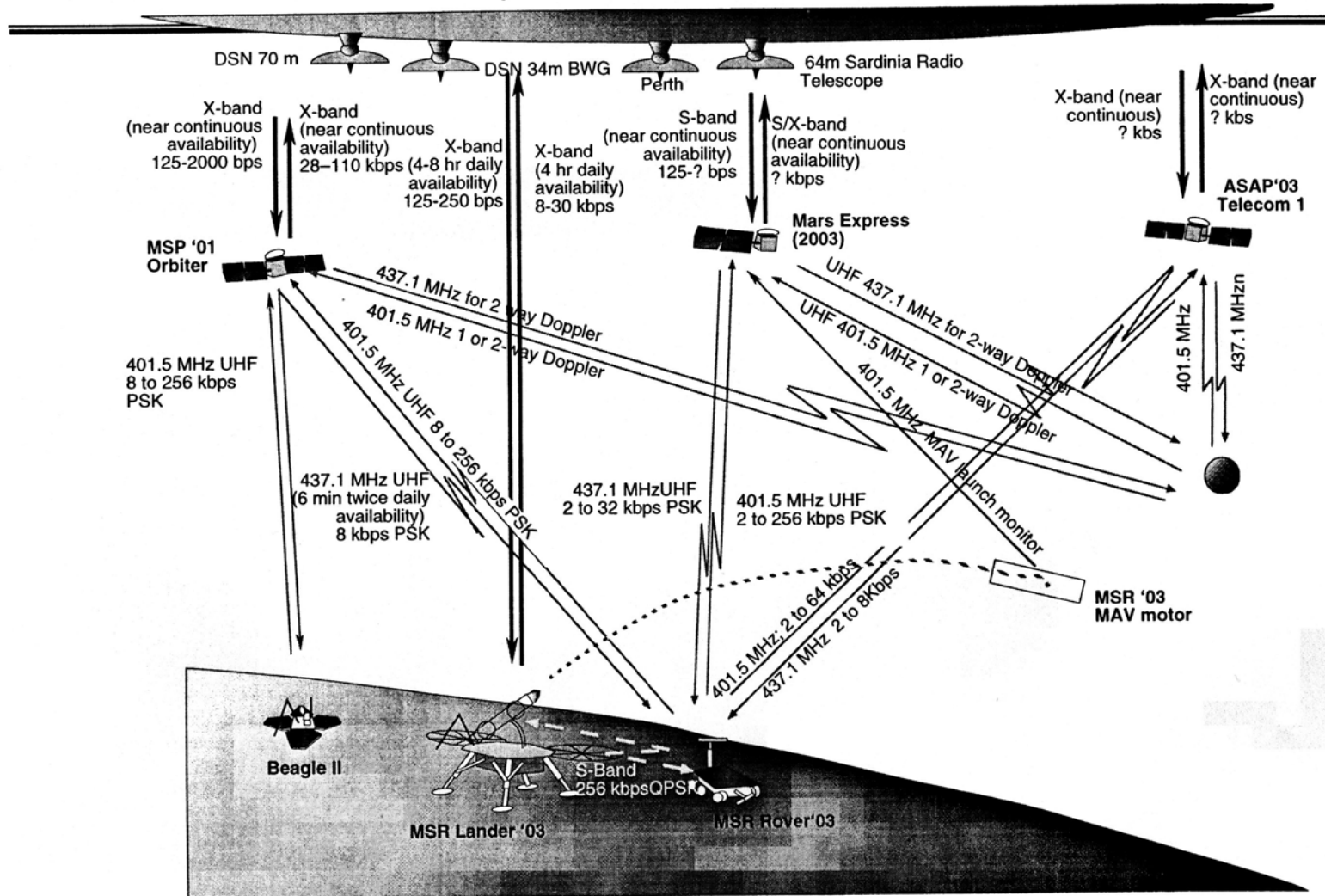

Failure Mode Analysis

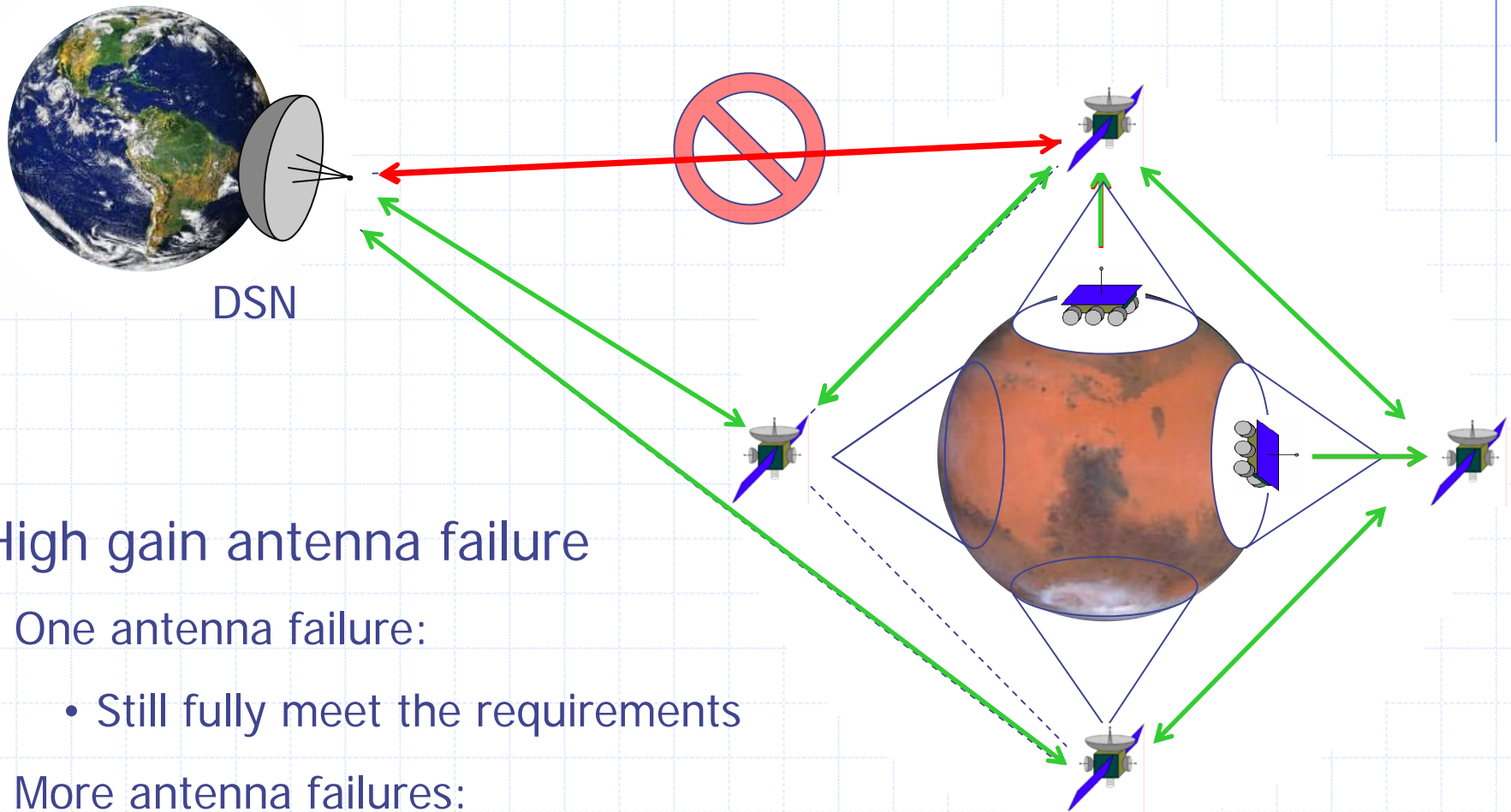

High gain antenna failure

- One antenna failure:
 - Still fully meet the requirements
- More antenna failures:
 - Graceful degradation of performance

Failure Mode Analysis

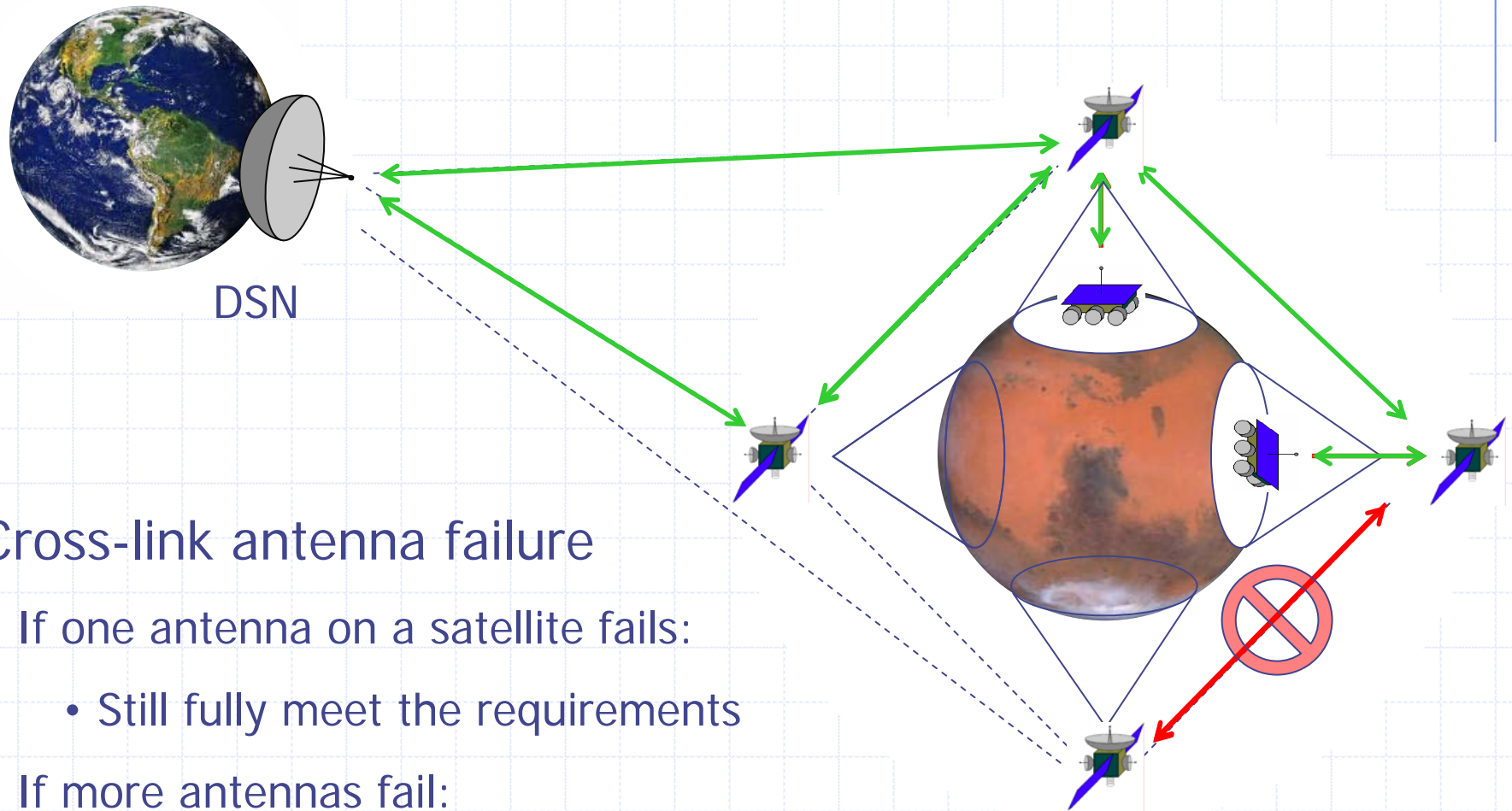

Cross-link antenna failure

- If one antenna on a satellite fails:
 - Still fully meet the requirements
- If more antennas fail:
 - Graceful degradation of performance

Failure Mode Analysis

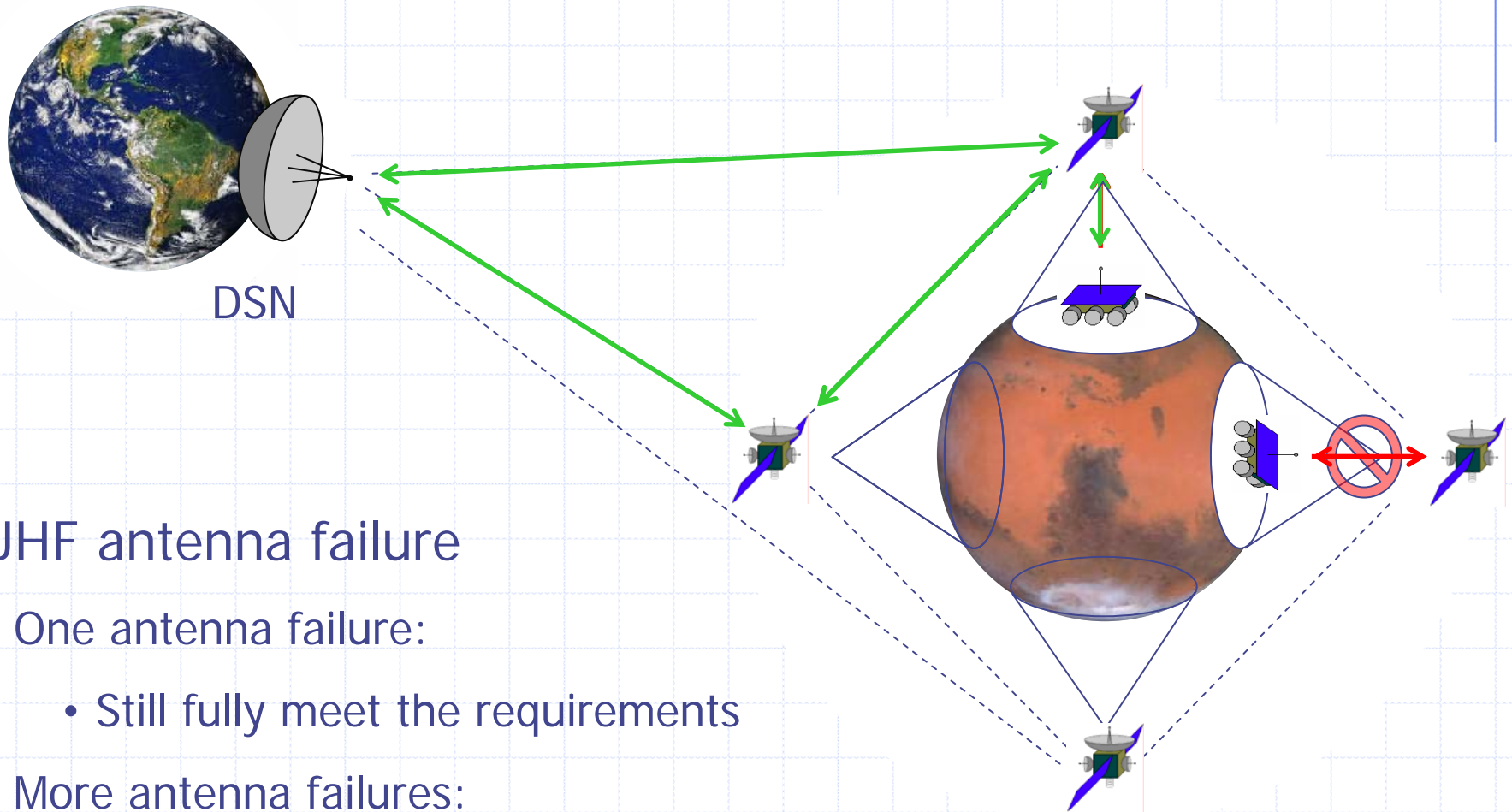

UHF antenna failure

- One antenna failure:
 - Still fully meet the requirements
- More antenna failures:
 - Graceful degradation of performance

Accuracy Over Time

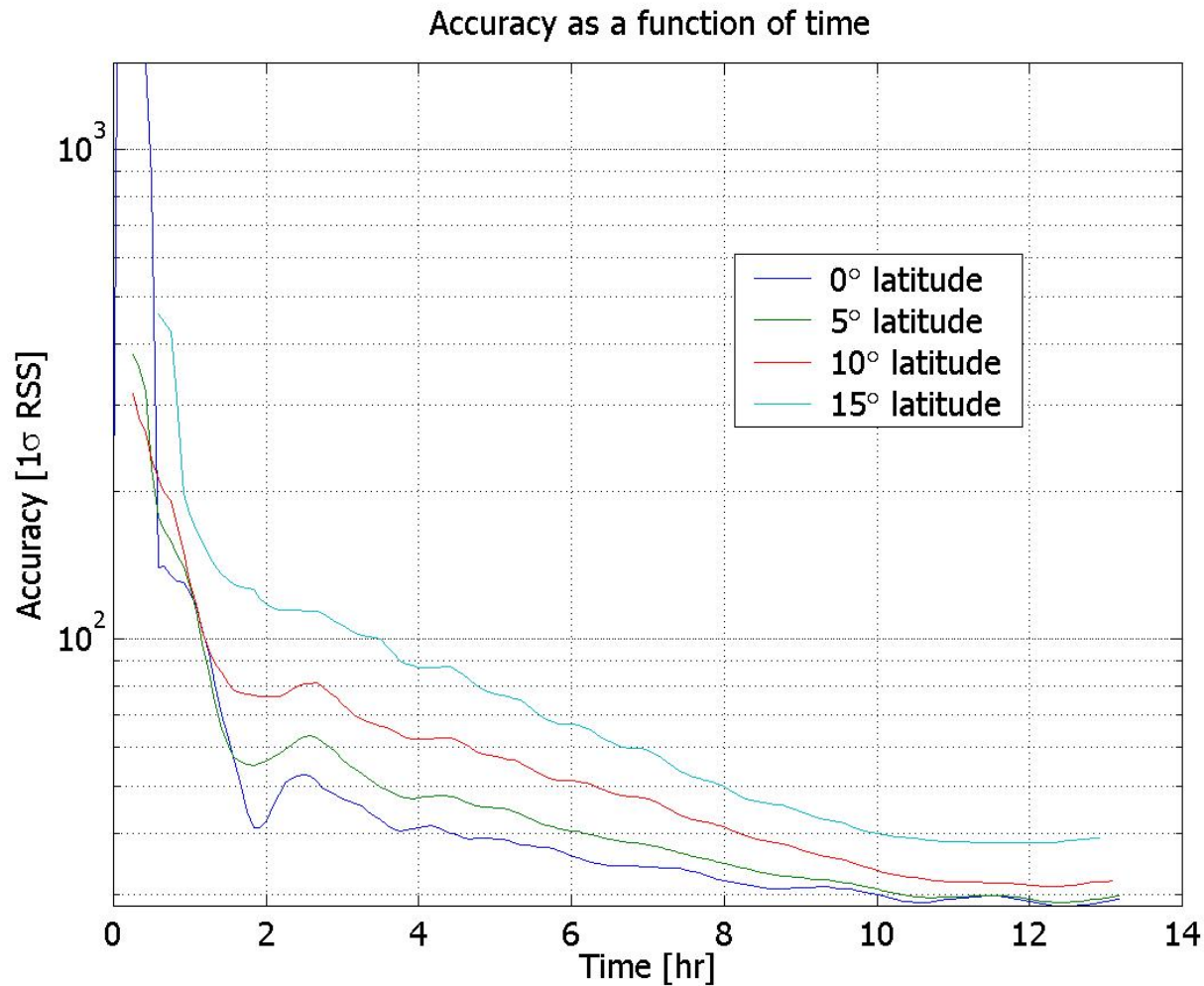

Positioning Performance

- ◆ First estimate accuracy depends on geometry w.r.t. satellite ground track
- ◆ Time to reach accuracy is a function of
 - Orbital inclination
 - MSE latitude
- ◆ Best performance around the equator (coverage)

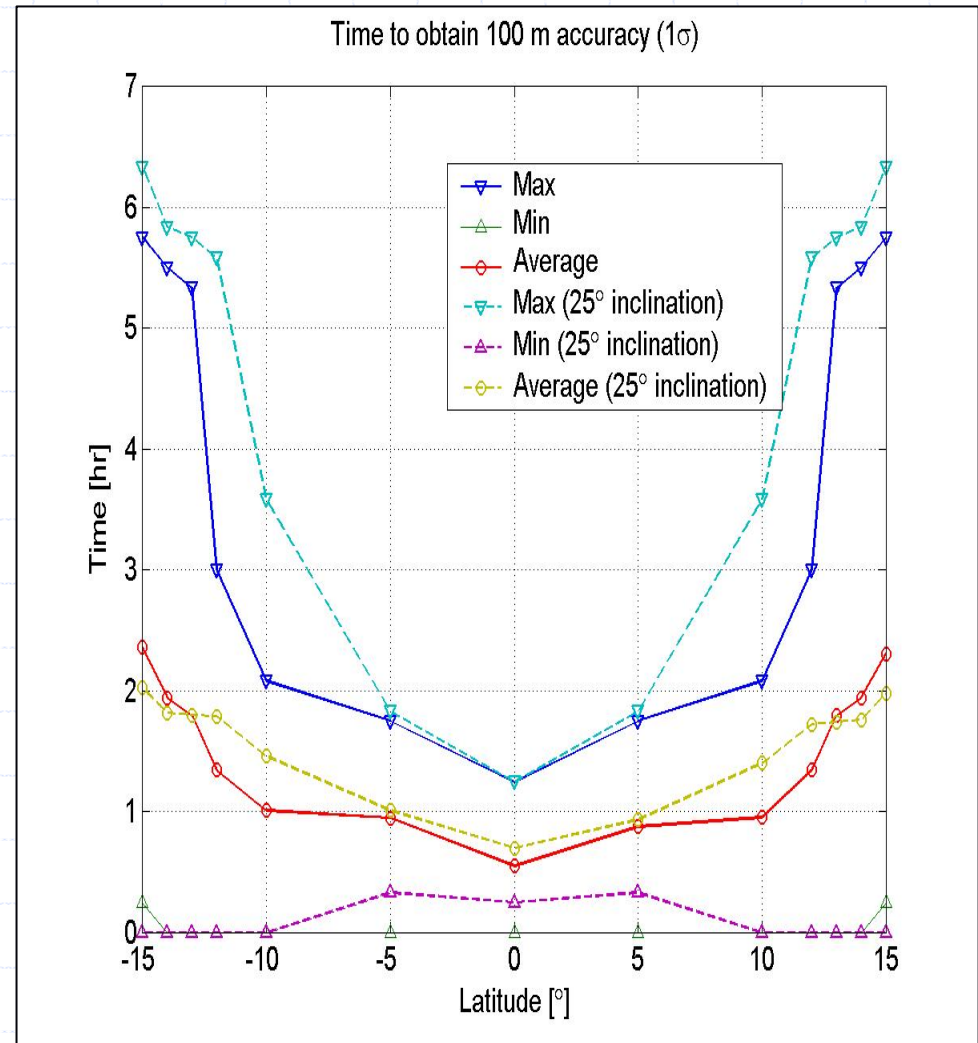

Positioning Performance

- ◆ Comparison with 30 degrees inclination:

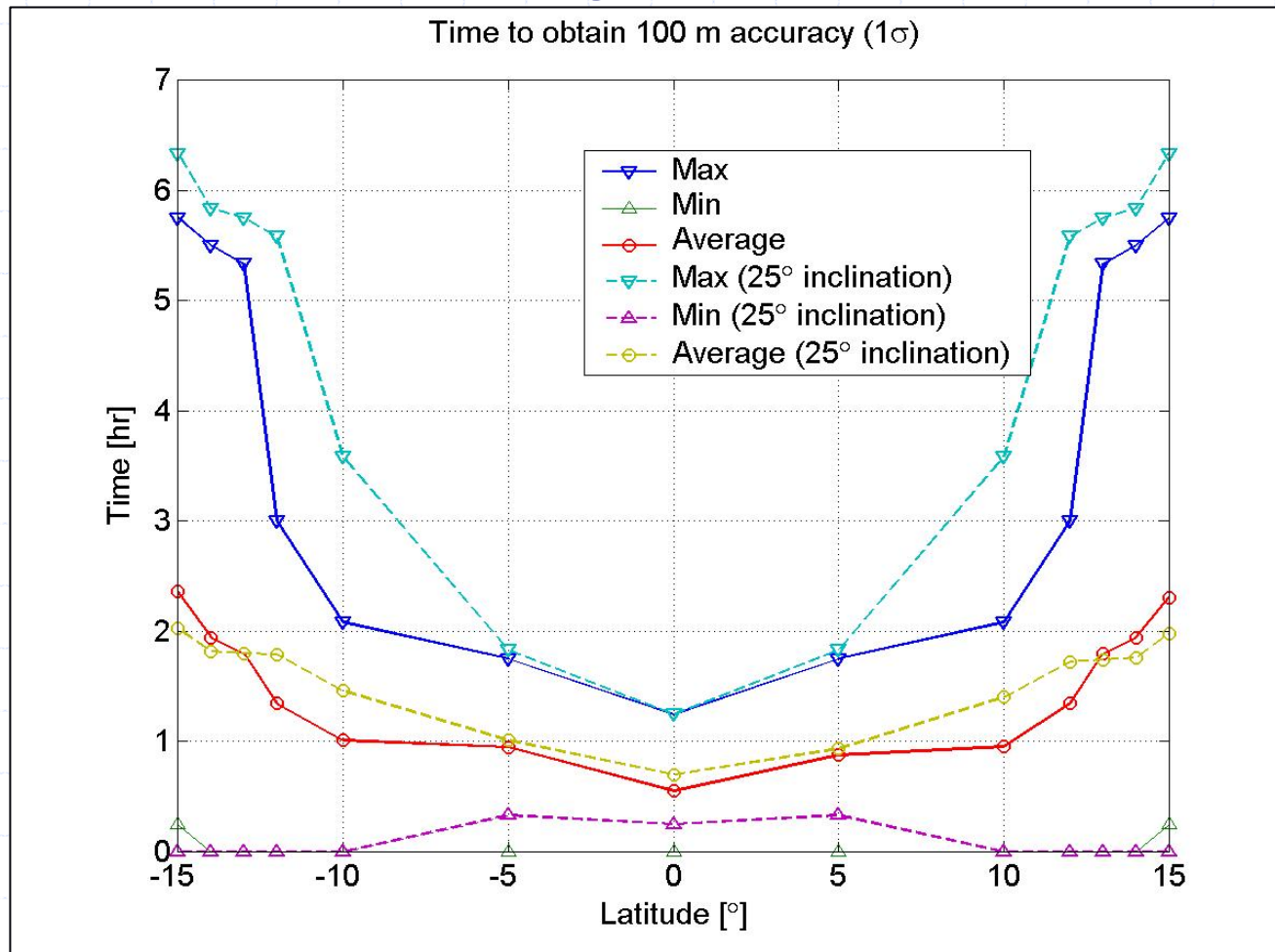

Time to Get 100 m Accuracy: Comparison with 30° inclination

- ◆ Probability to reach 100 m accuracy (1σ) within certain time:

0° latitude

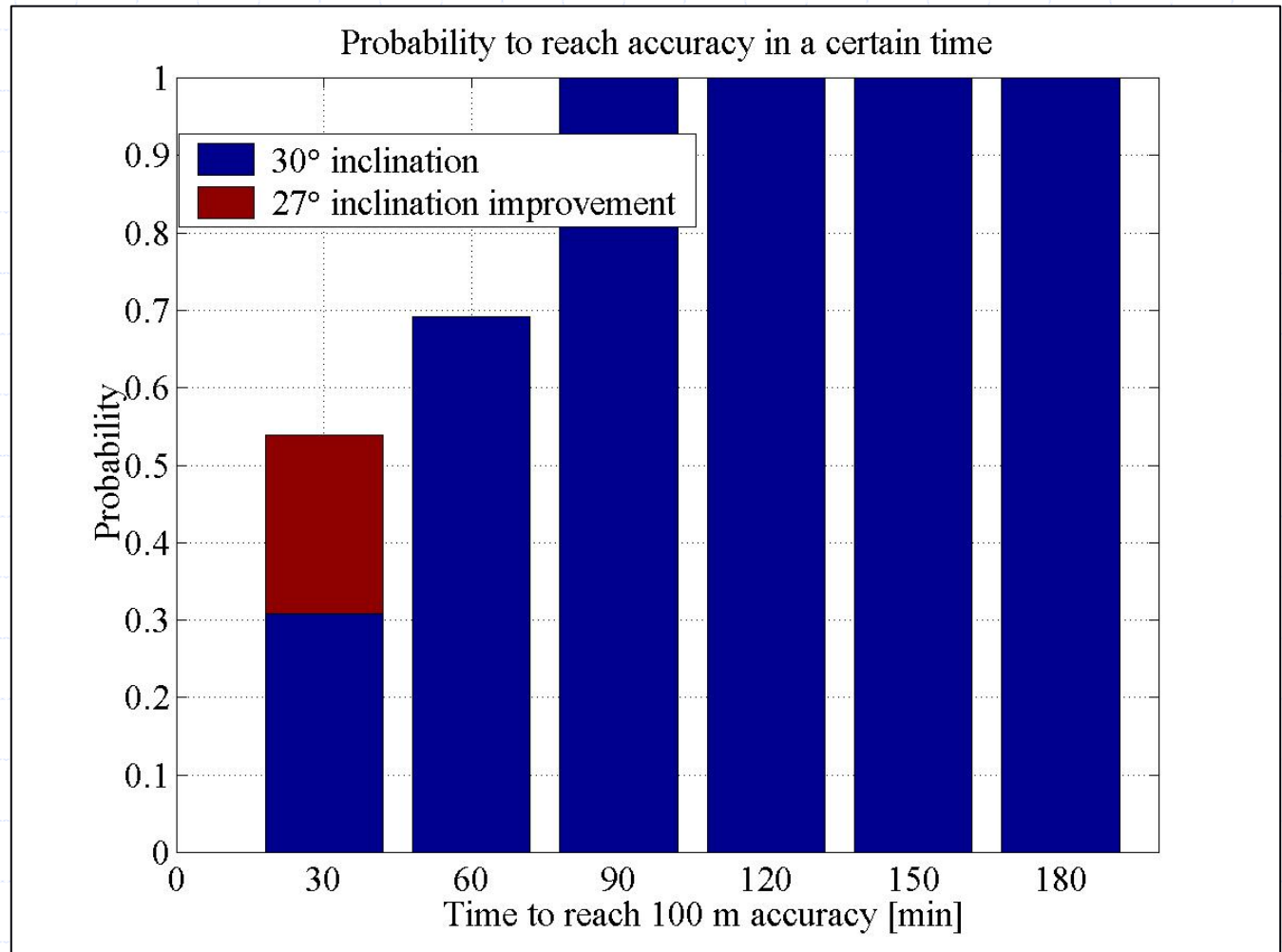

Time to Get 100 m Accuracy: Comparison with 30° inclination

- ◆ Probability to reach 100 m accuracy (1σ) within certain time:

15° latitude

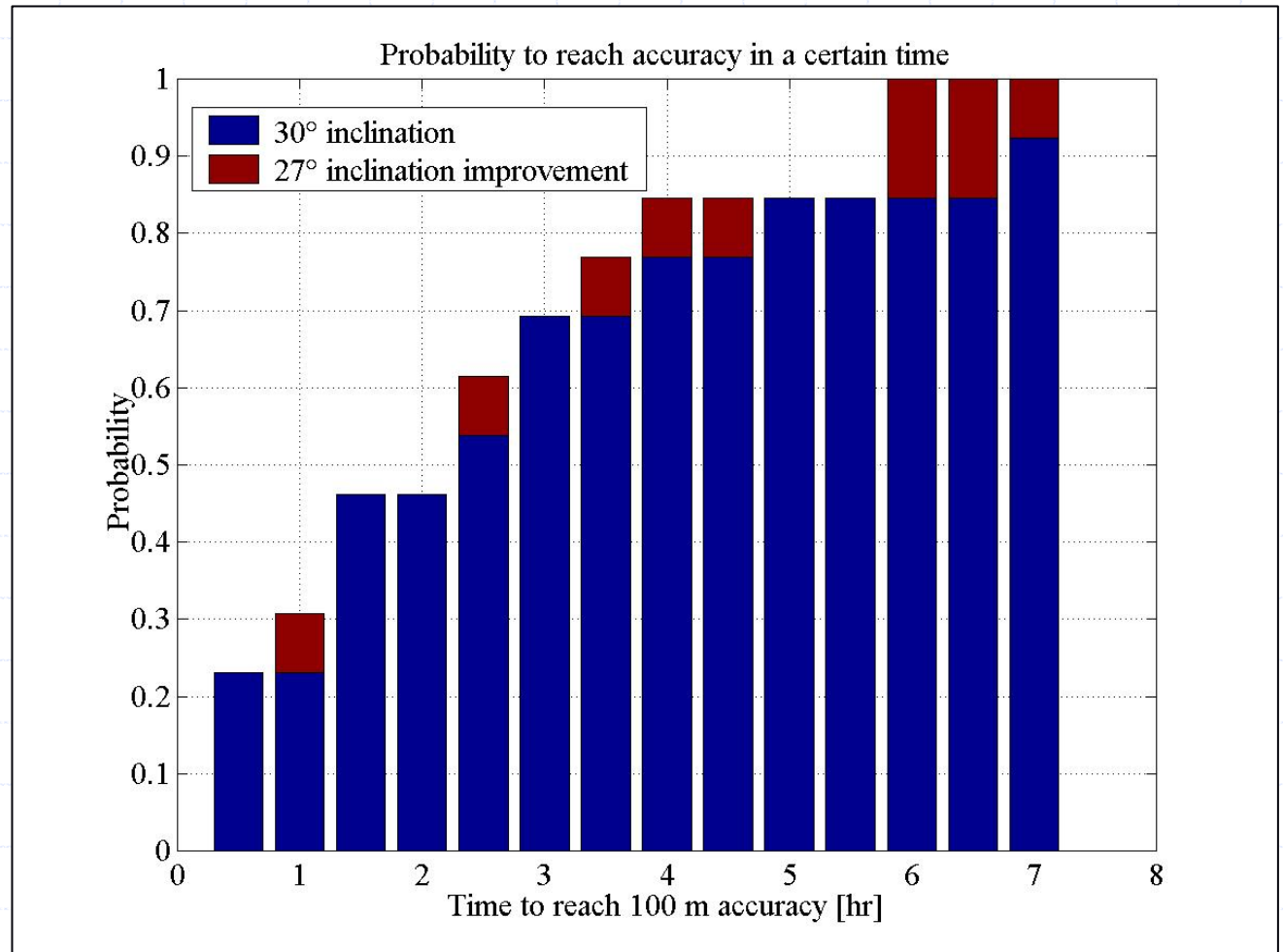

Time to Get 100 m Accuracy: Comparison with 25° inclination

- ◆ Probability to reach 100 m accuracy (1σ) within certain time:

0° latitude

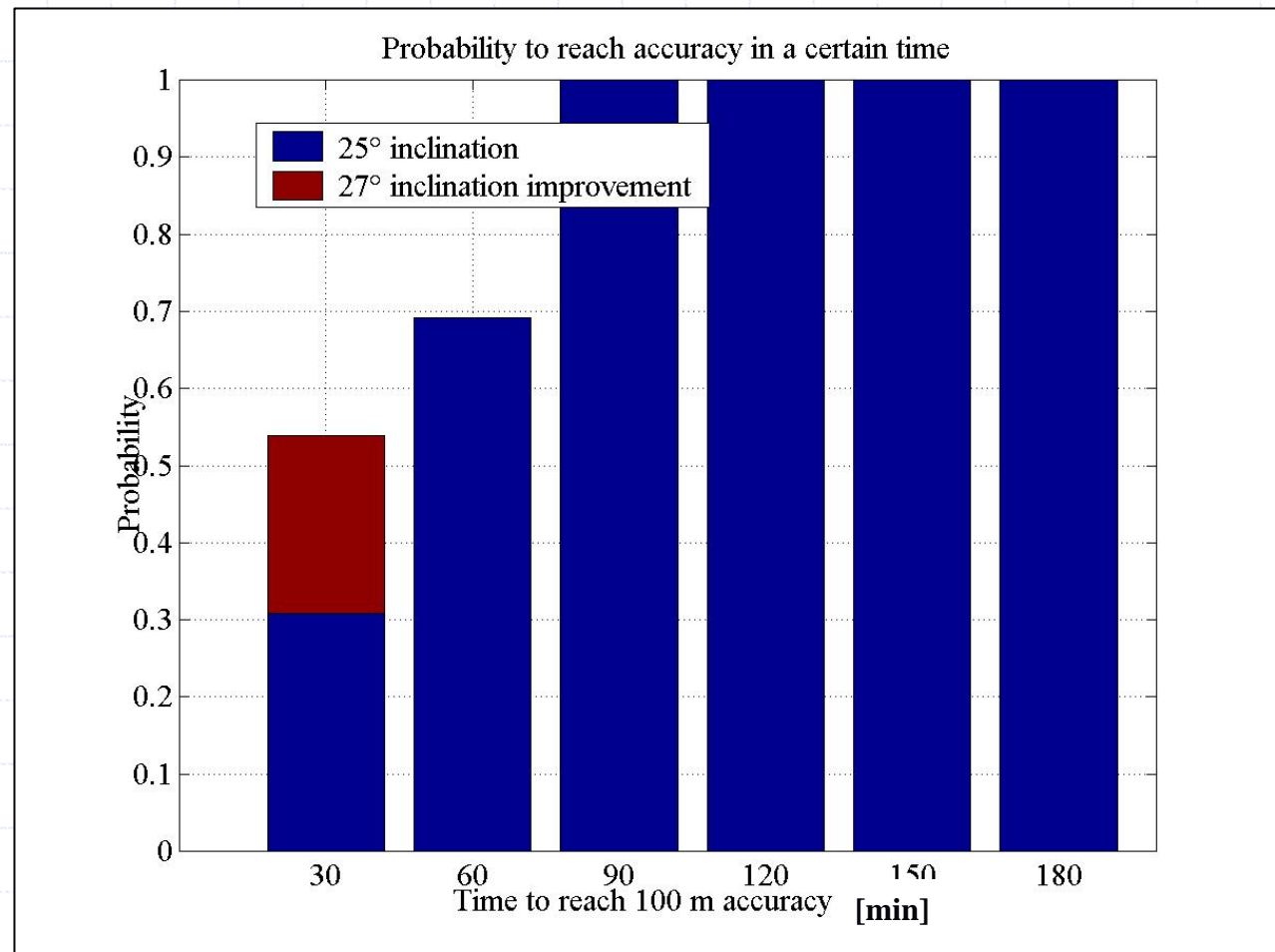

Time to Get 100 m Accuracy: Comparison with 25° inclination

- ◆ Probability to reach 100 m accuracy (1σ RSS) within certain time:

15° latitude

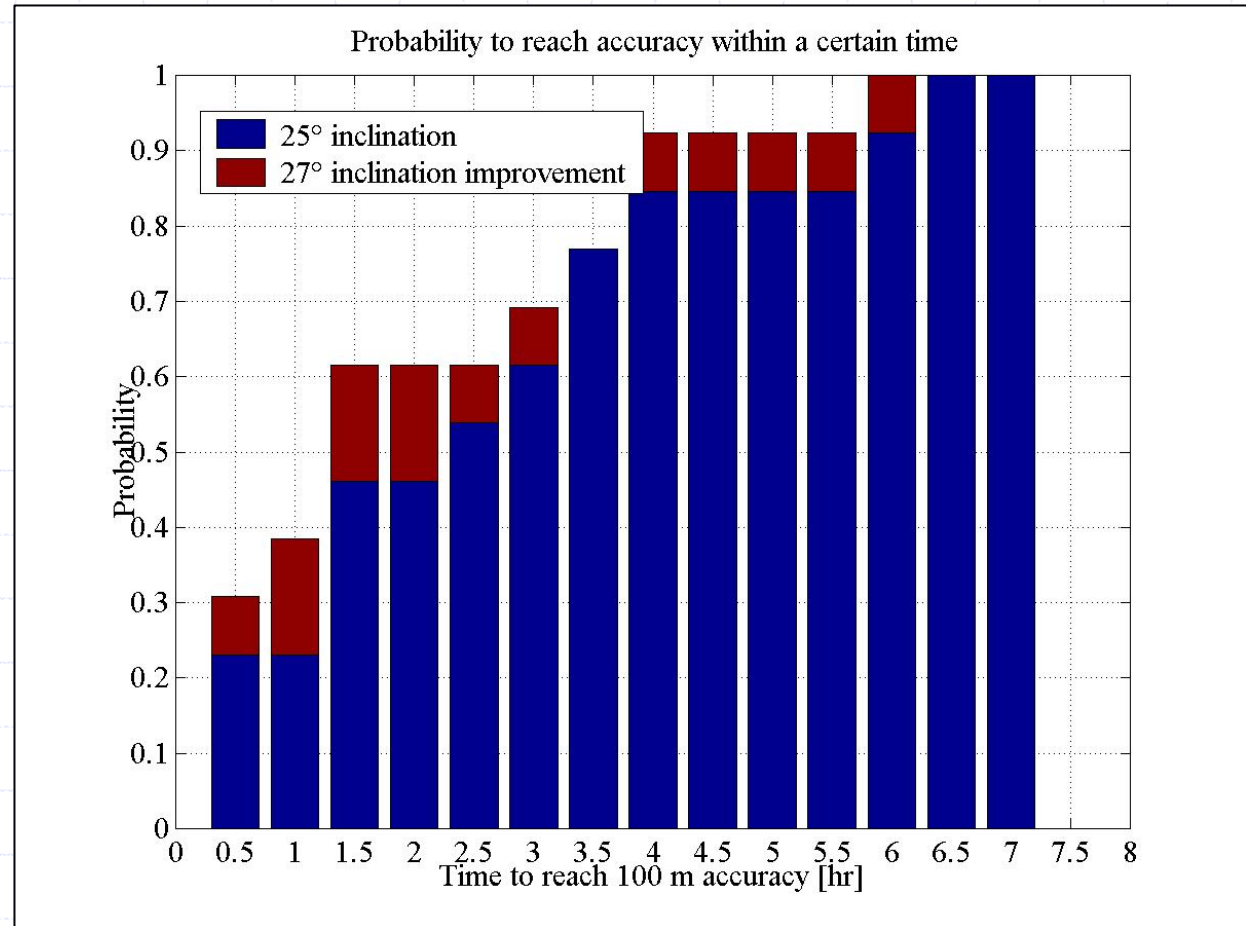

Software Cost

- ◆ Software cost estimated by SLOC

Cost per SLOC	Flight Software	Ground Software
Ada	\$ 435	\$ 220
C	\$ 726	\$ 220

Computer Hardware - RAD 6000

- ◆ Radiation hardened version of IBM Risc 6000 Single Chip CPU (32 bit)
 - Chip dimensions: 8" x 9" x 2" inches
 - Mass: ~5 kg
 - Memory: 128 MB of DRAM + 16 GB of EEPROM
 - MIL-STD-1553 interface
- ◆ Processing speeds
 - 20 MHz (22 MIPS) using 9 W
 - 10 MHz it (11 MIPS) using 5.5 W
 - 2.5 MHz (2.7 MIPS) it uses 2.5 watts.
- ◆ Two processors (2 for 1 redundancy)



Backup Slides: Bus Analysis

External Satellite Components

EXTERNAL COMPONENTS

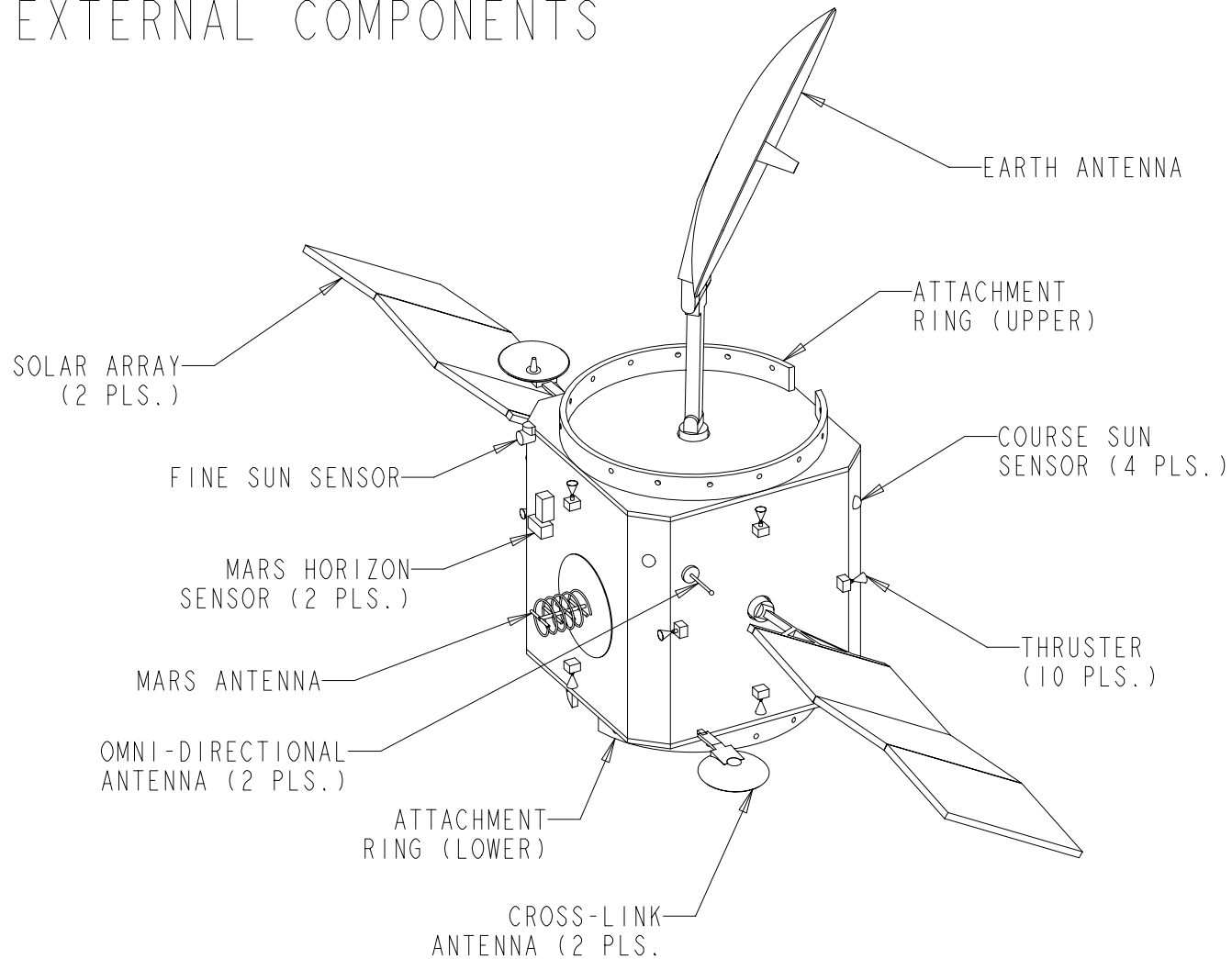

Internal Satellite Components

INTERNAL COMPONENTS

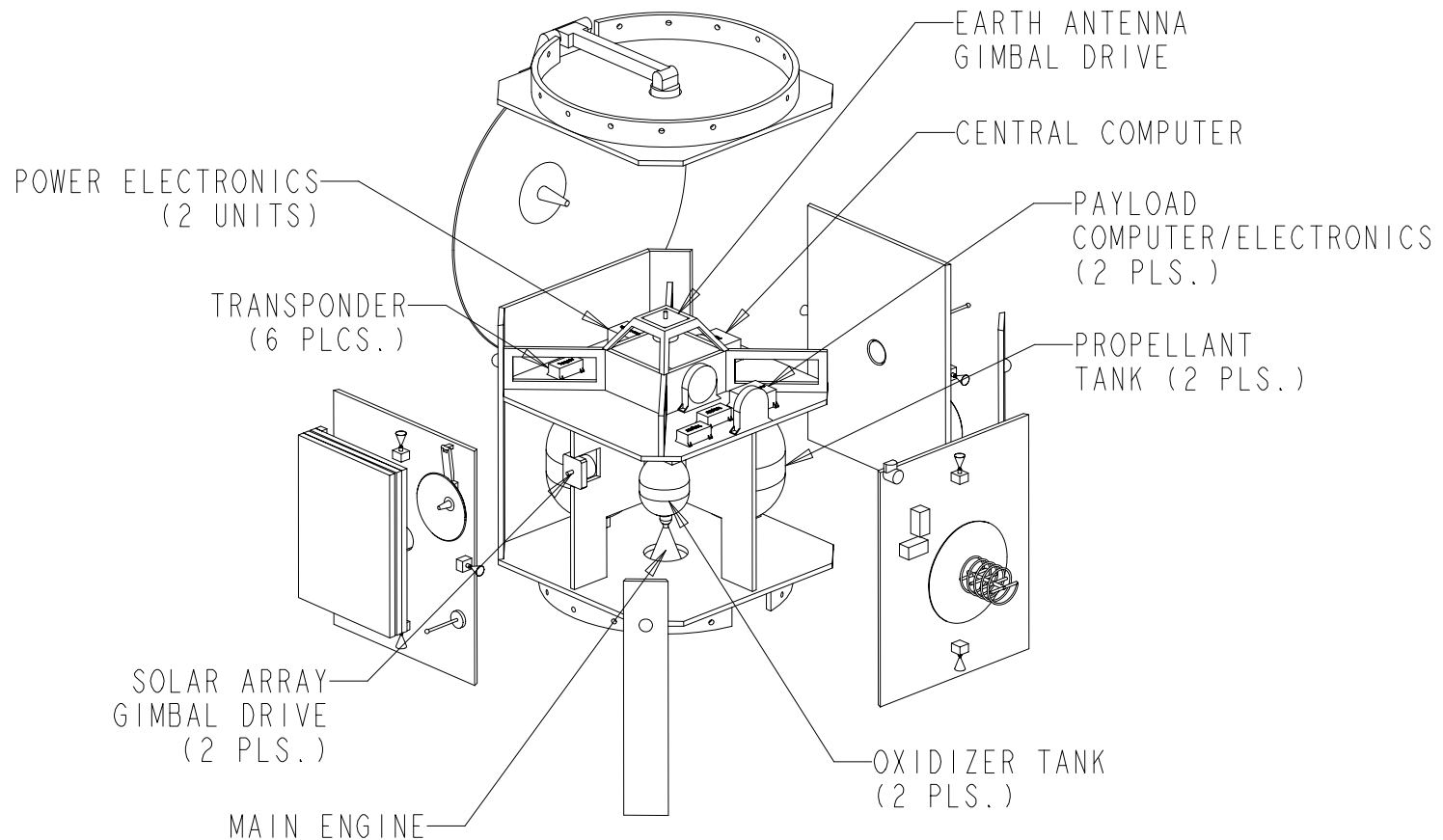



Backup Slides: Launch Analysis

Launch Vehicle Performance

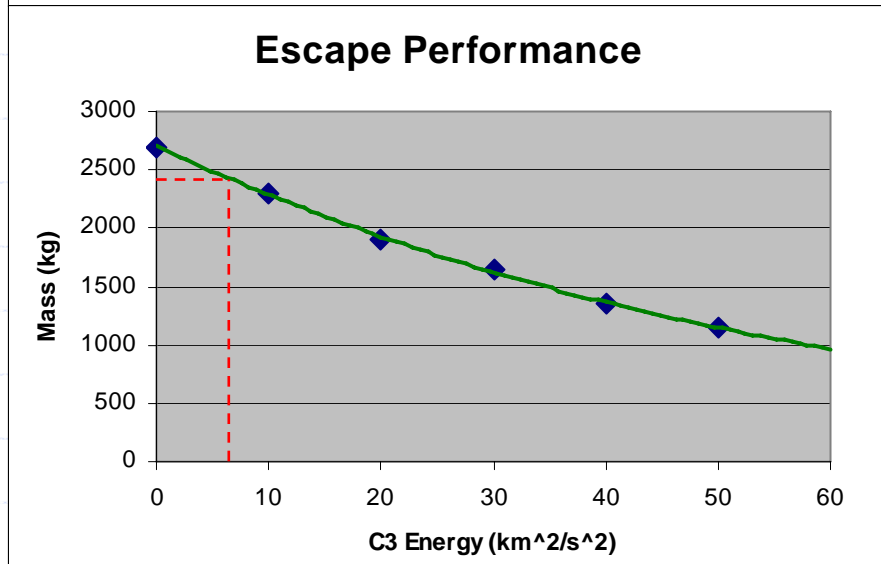
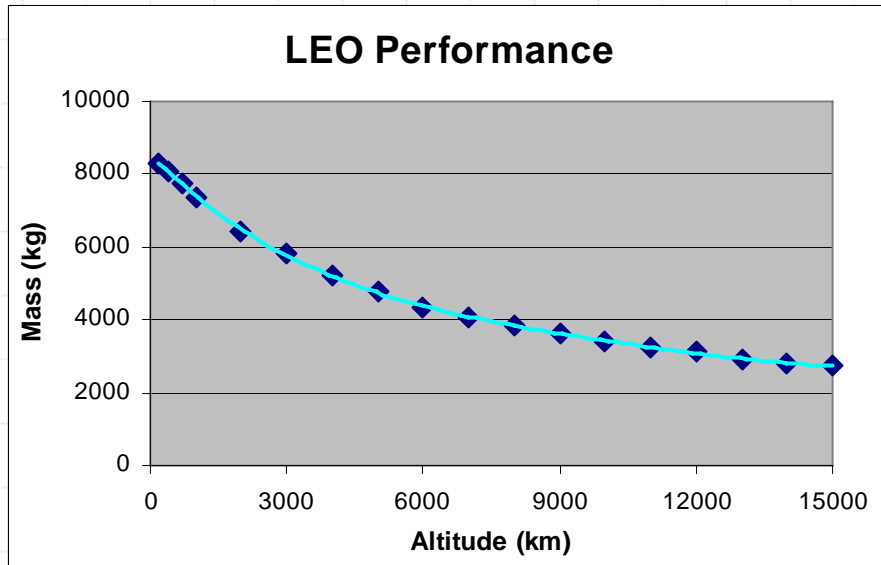



Backup Slides: Operations Analysis

Functional Flow

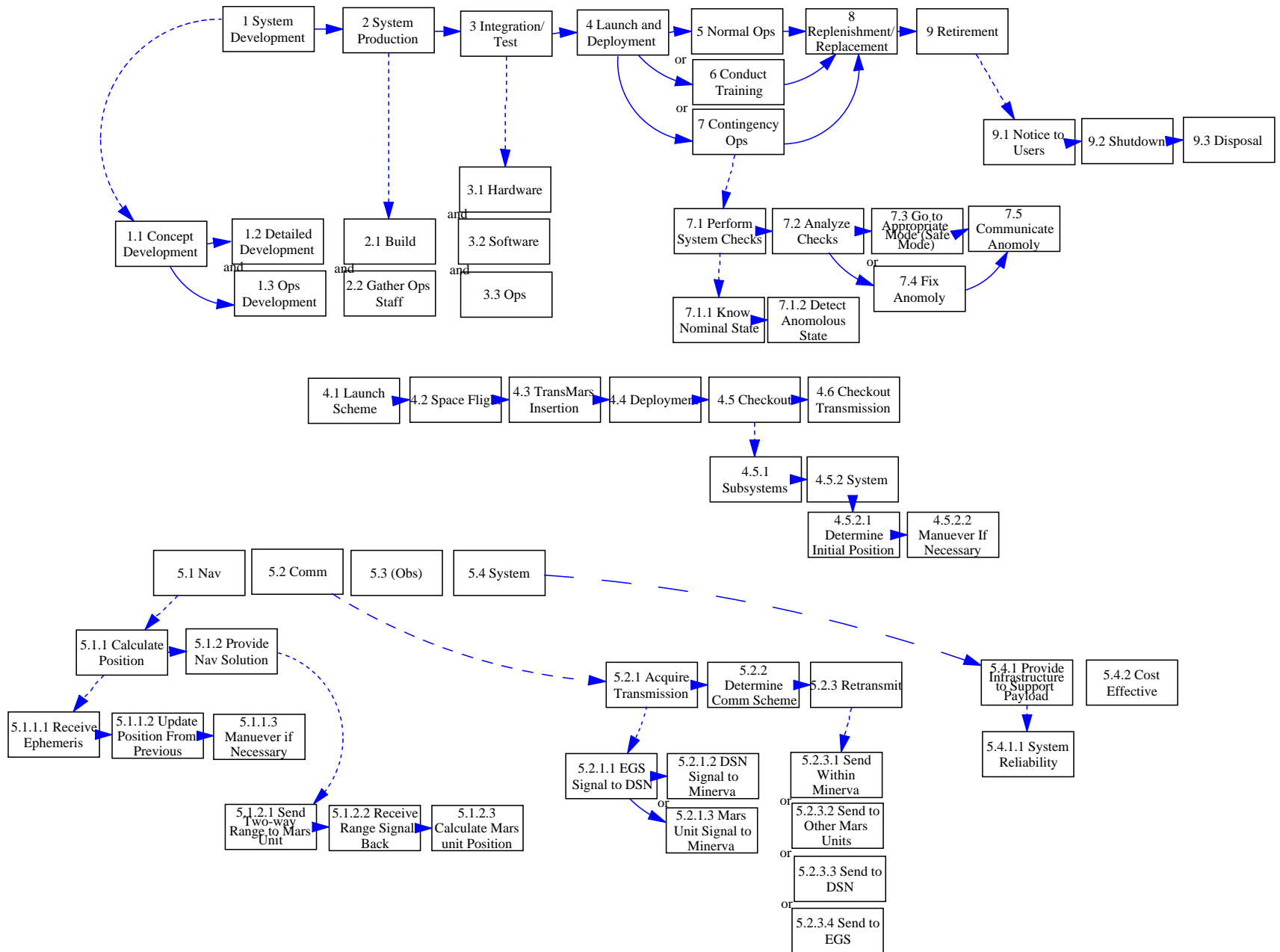

Earth Uplink

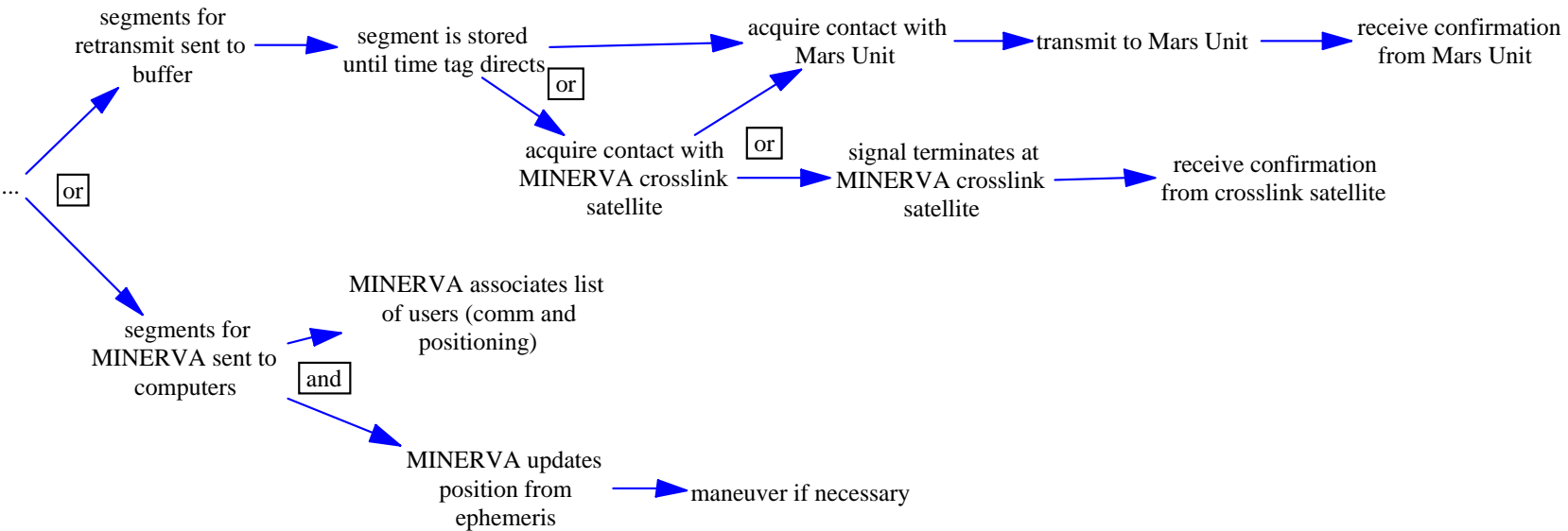
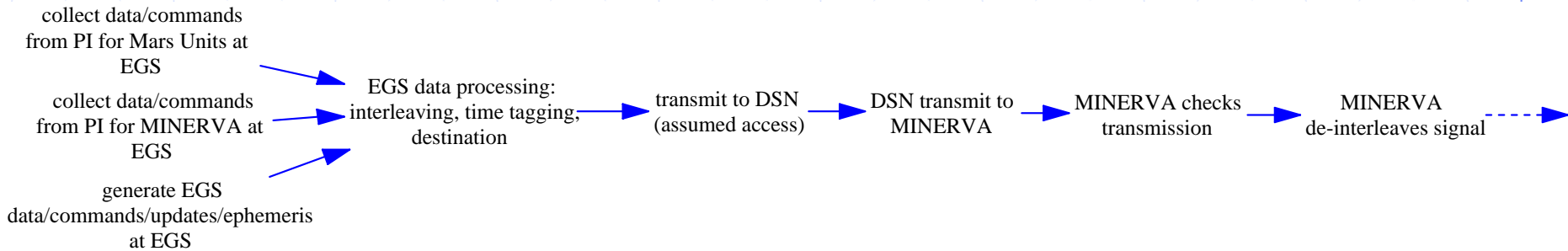

Mars Uplink

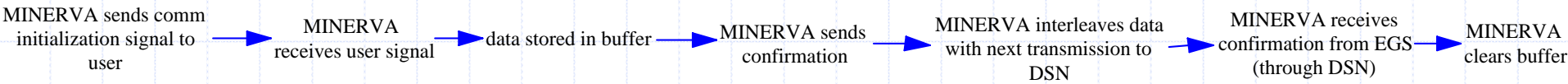

Positioning Loop

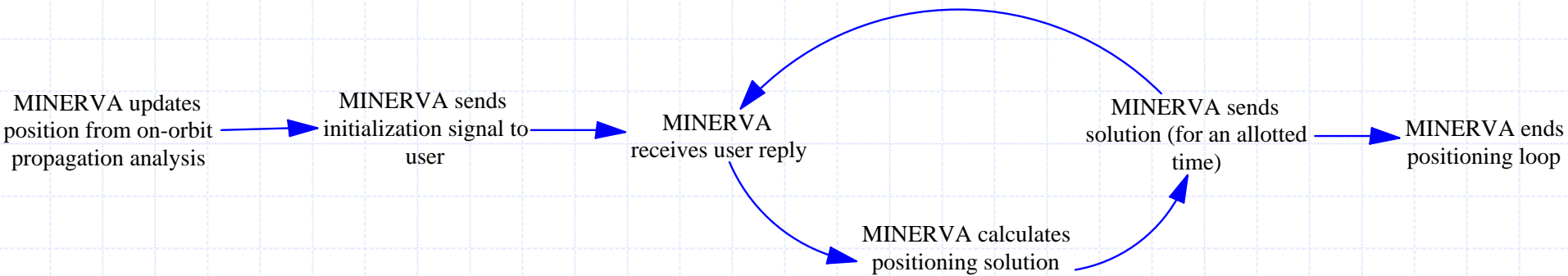

Anomaly Resolution

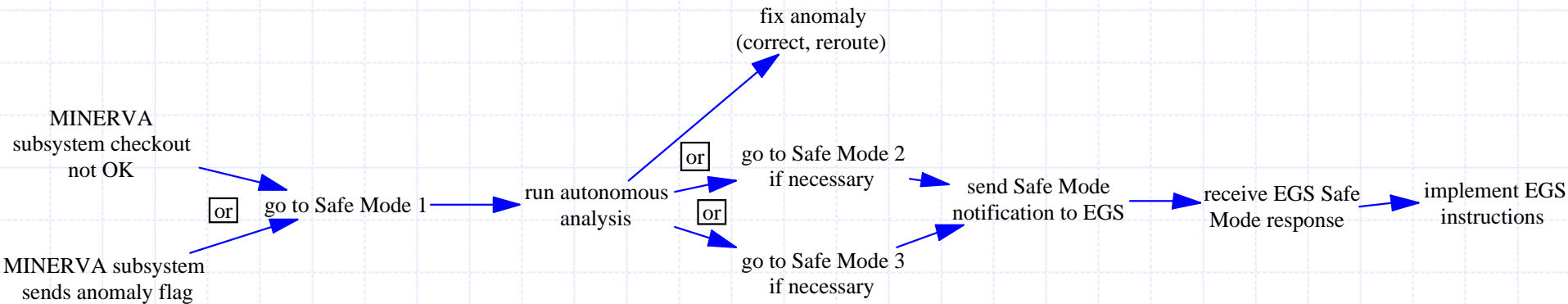

Failure Tree: Setup

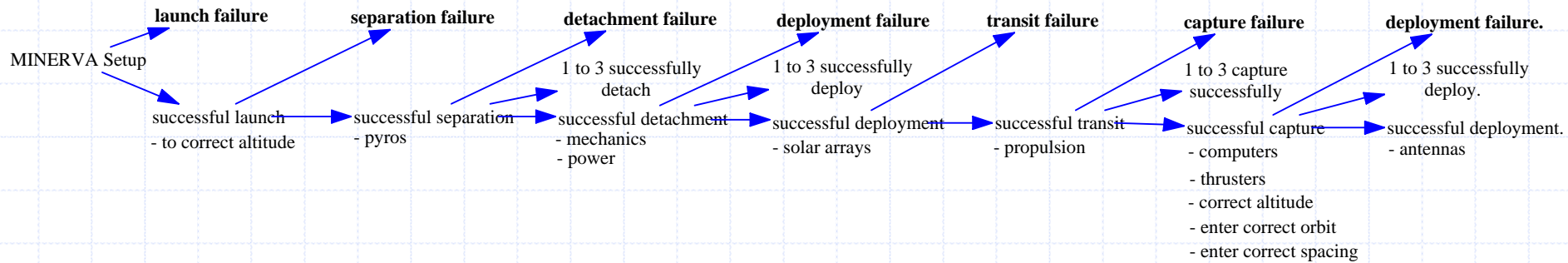

Failure Tree: Normal Lifetime Ops

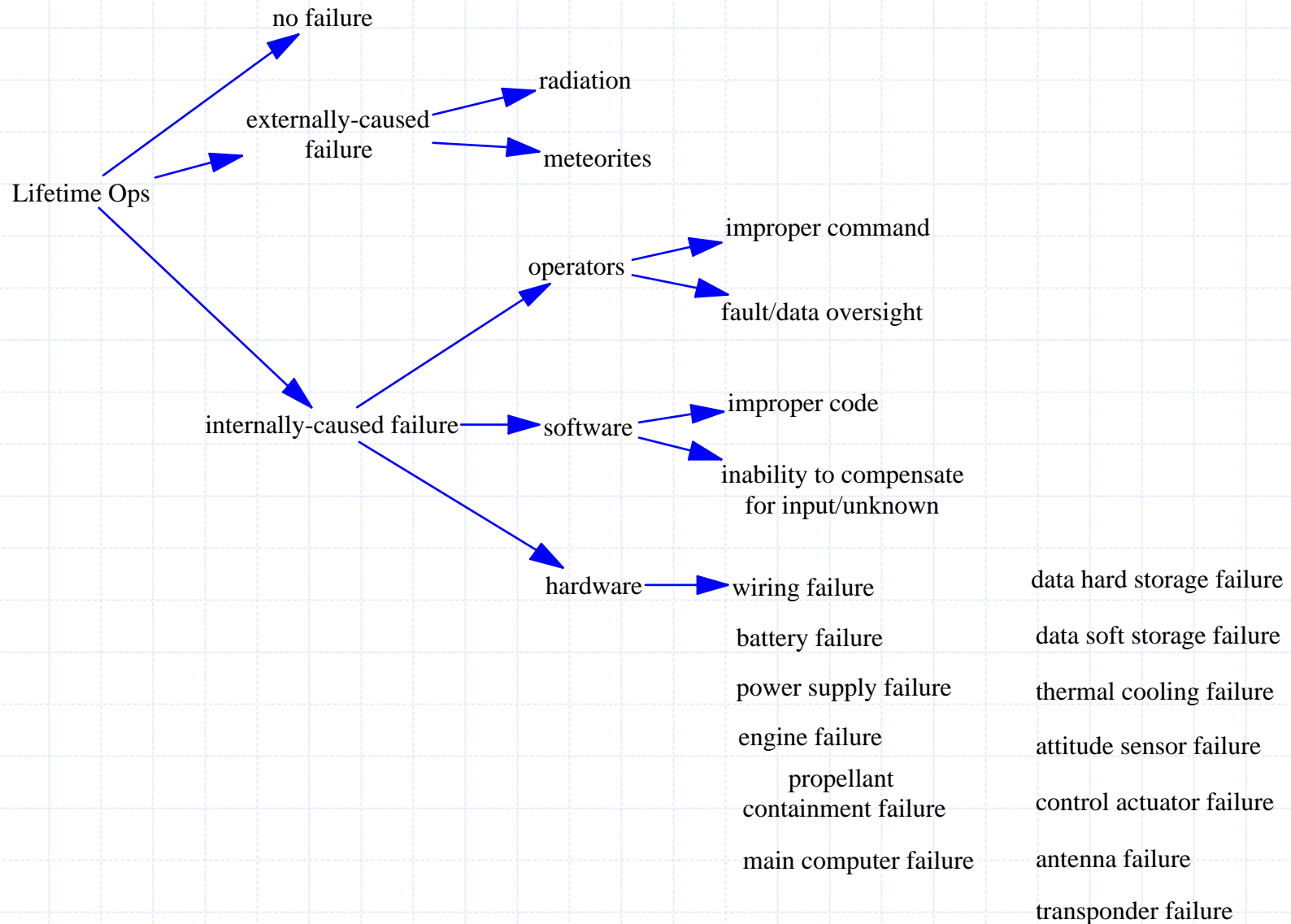

Reliability (and Failure Rates)

- ◆ Launch: 0.997 (or 0.90)
- ◆ Separation: 0.99
- ◆ Detachment: 0.99
- ◆ Transit: (0.005 failures/year)
- ◆ Capture: 0.99
- ◆ Deployment: 0.99
- ◆ ADCS: (0.001 failures/year)
- ◆ Payload: (0.00201 failures/year)
- ◆ Power: (***) failures/year)
- ◆ Propulsion: (0.005 failures/year)
- ◆ Thermal: (0.002 failures/year)
- ◆ Computers: (0.005 failures/year)



Backup Slides: Cost Analysis

Cost Trade: Level of Autonomy

- ◆ Problem: Spacecraft autonomy drives software costs
- ◆ Trade space:
 - Highly autonomous s/c functions
 - ◆ Flight software: \$24.8M
 - ◆ Ground software: \$50M
 - Minimal s/c autonomy (on-board position fix)
 - ◆ Flight software: \$17.6M
 - ◆ Ground software: \$20.5M
 - Minimal s/c autonomy (Earth position fix)
 - ◆ Flight software: \$16.4M
 - ◆ Ground software: \$19.1M
- ◆ Decision: Select minimal autonomy (Earth position fix) due to program cost constraints

Notes on Concurrent Engineering

- Design sessions enabled thorough exploration of trade space via real-time inter-team communication
 - ◆ Earth parking orbit
 - ◆ Constellation altitude
 - ◆ # s/c
 - ◆ Orbit inclination
- ICEMaker is useful interfacing tool
- More automation would speed process
 - ◆ Models in Excel
 - ◆ Matlab/Excel integration