

MIT OpenCourseWare  
<http://ocw.mit.edu>

4.500 Introduction to Design Computing  
Fall 2008

For information about citing these materials or our Terms of Use, visit: <http://ocw.mit.edu/terms>.

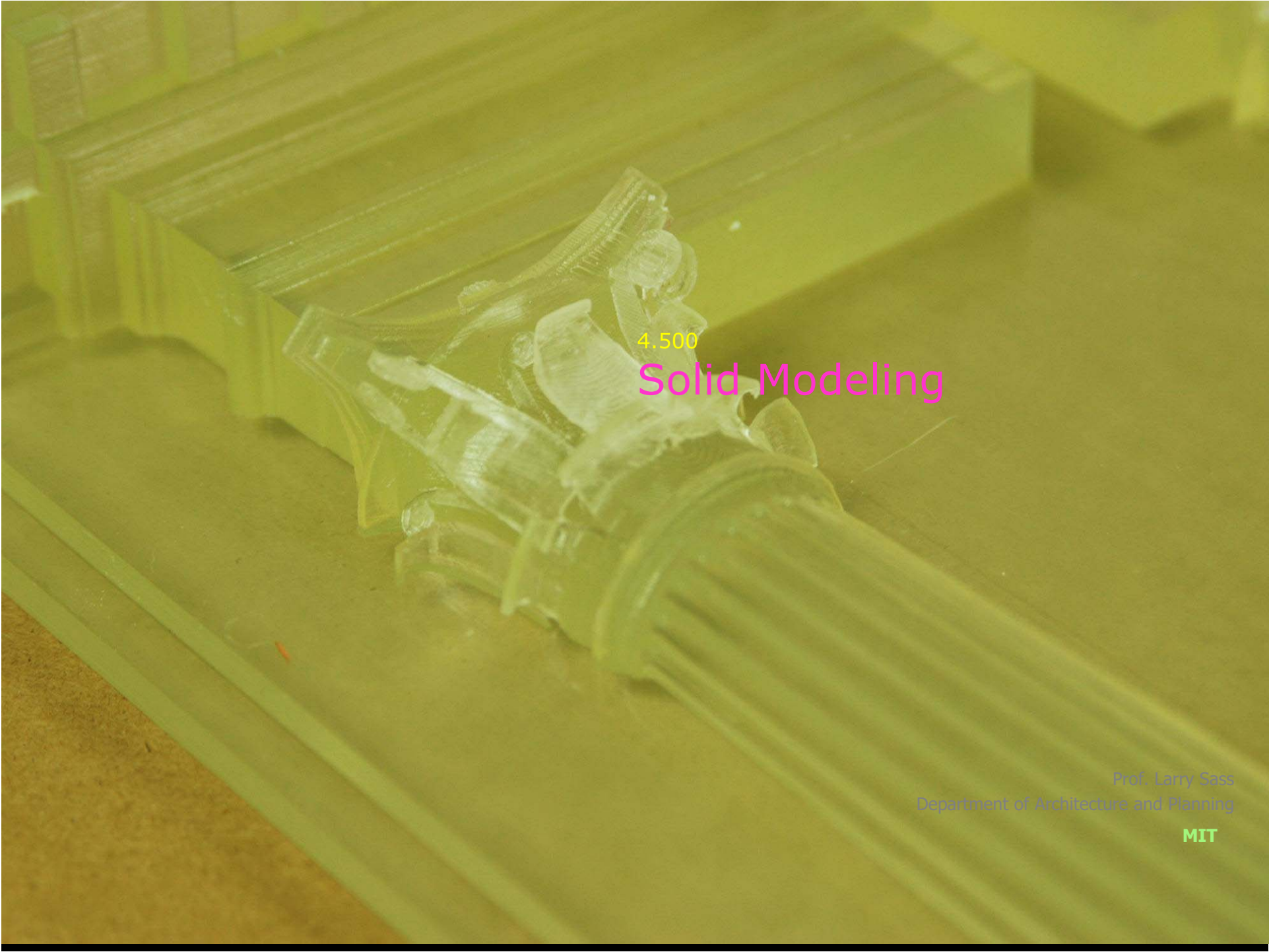

4.500

## Solid Modeling

Prof. Larry Sass  
Department of Architecture and Planning

MIT



## Lecture 2

[1] Computer Modeling

[2] Solid Modeling Operations

[3] Background

[4] Modeling Functions

[5] Homework

[1]  
Modeling

# Solid Modeling

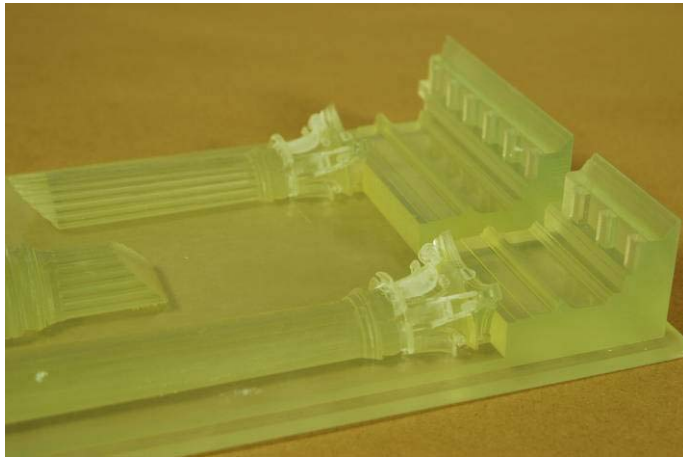

- Stereo Lithography
- 3D Printing
- FDM Printing

# 3d Printing

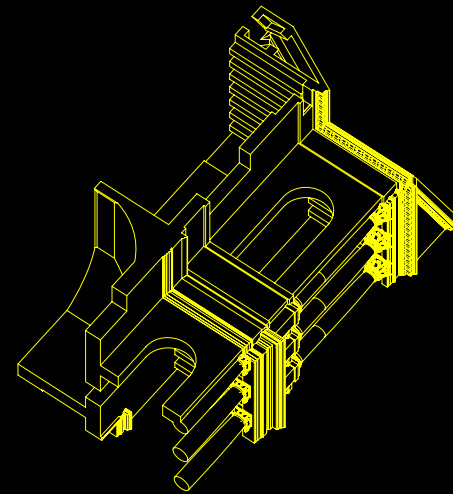
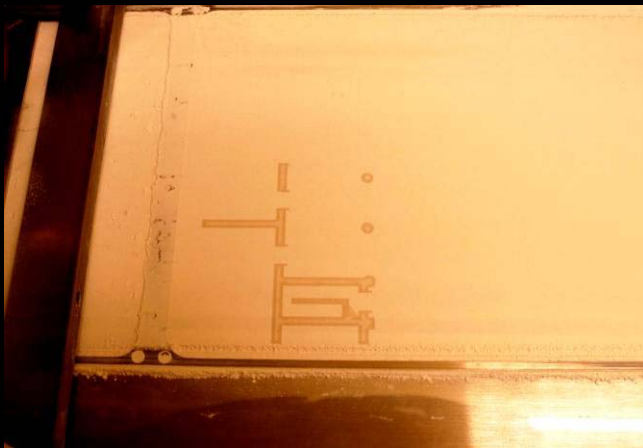
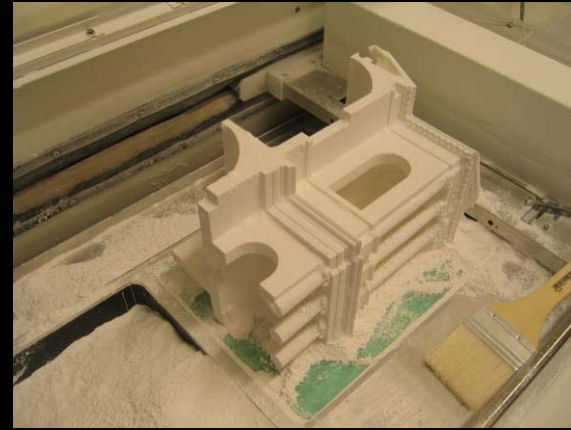
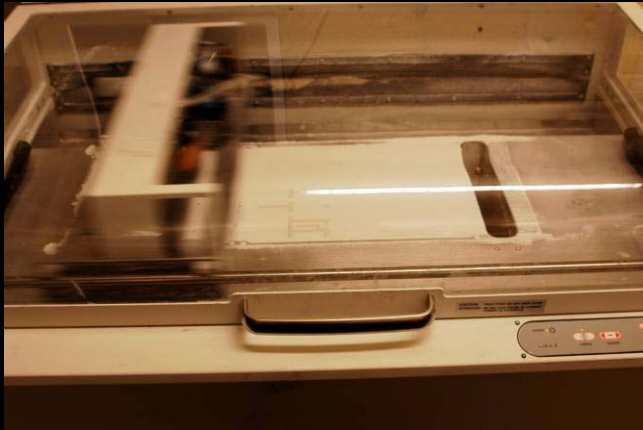

# Types of Solid Models

- Solid Models
- Surface Models

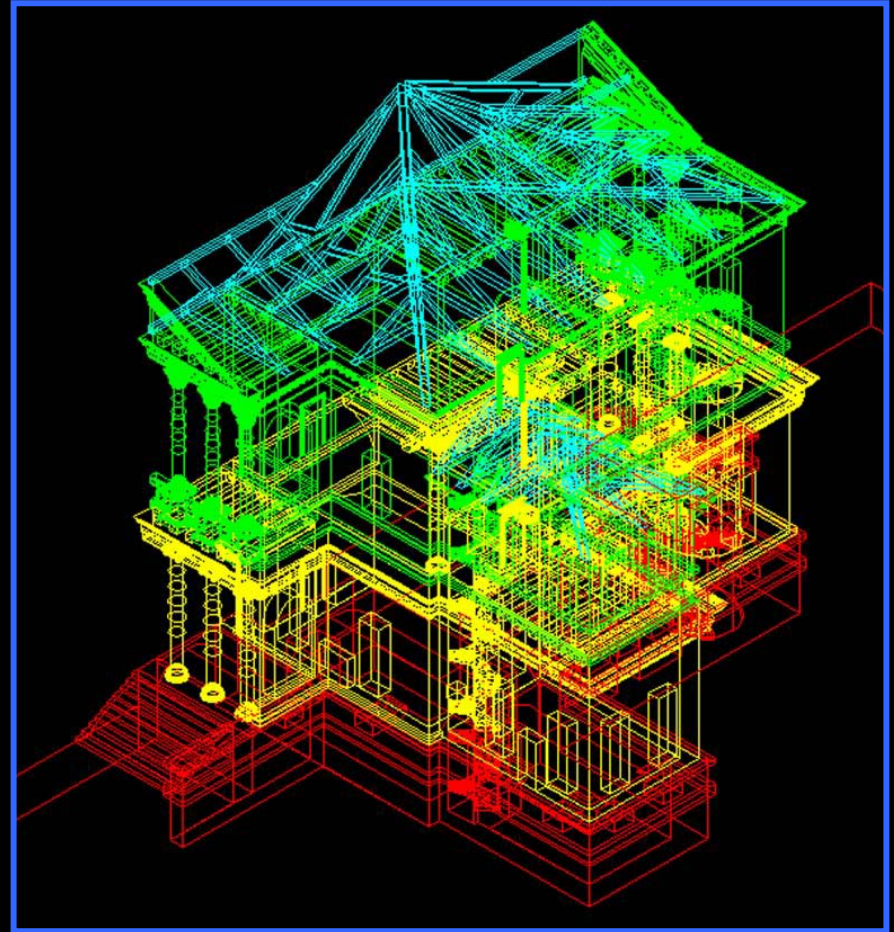

# Types of Solid Models

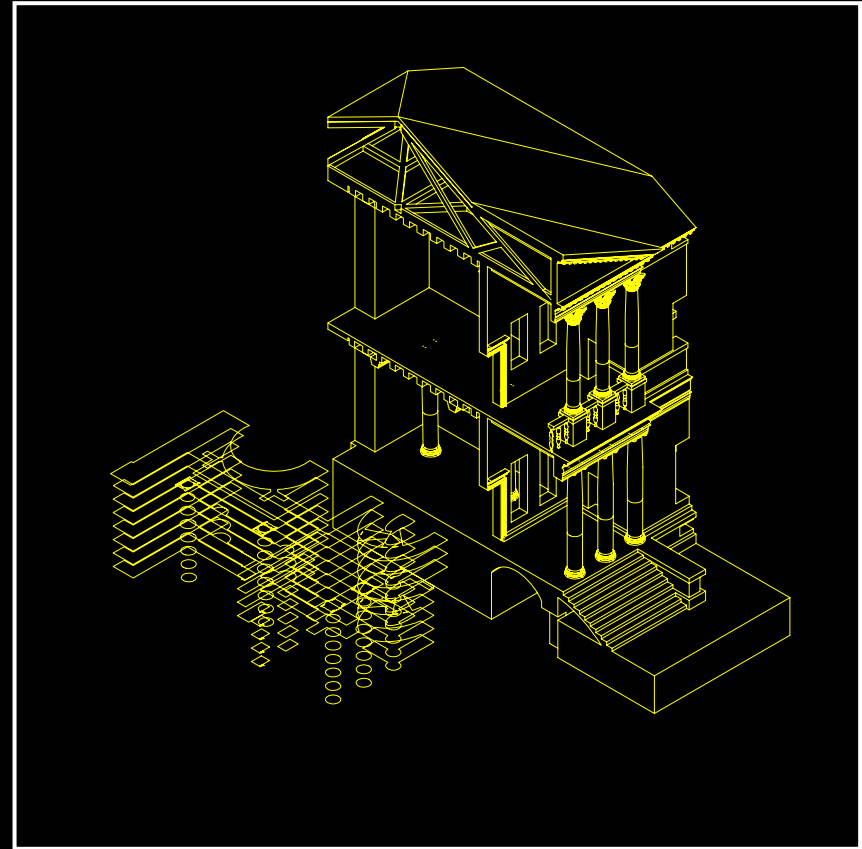
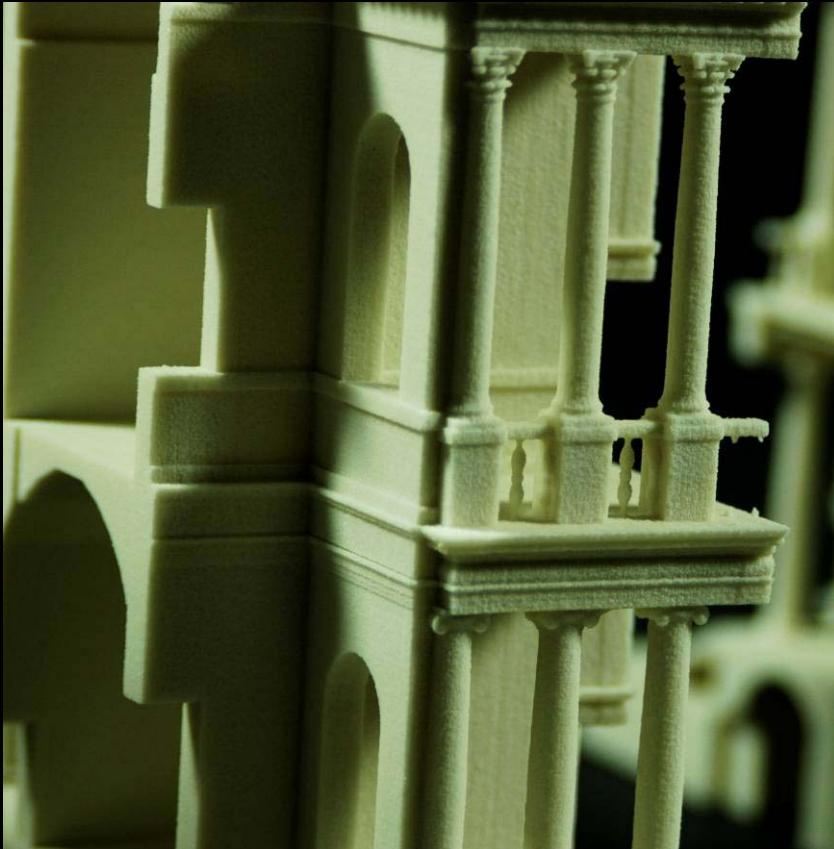



## Types of Representation

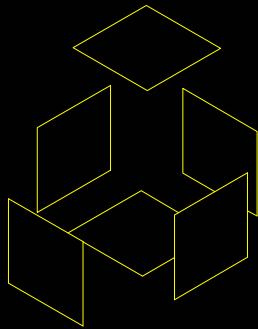

Surface Models

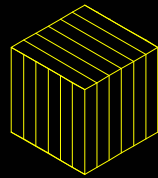

Ruled Surface

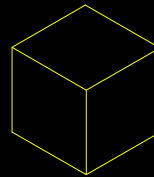

Solid Modeling

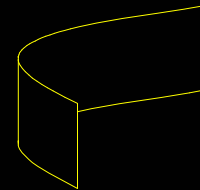

NURB Surface  
Modeling

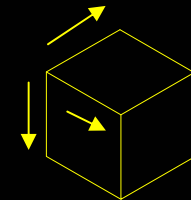

Parametric  
Modeling

# Types of Representation

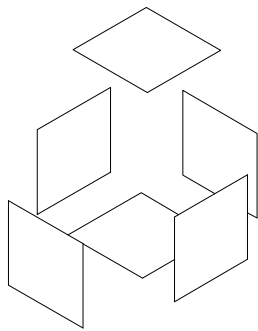

Surface Models

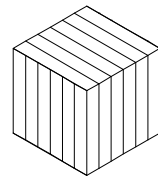

Ruled Surface

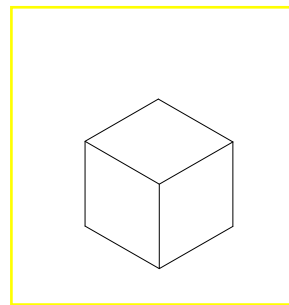

Solid Modeling

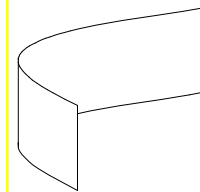

NURB Surface  
Modeling

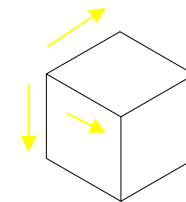

Parametric  
Modeling

[2]  
Solid Modeling

Surface Modeling



Solid Modeling

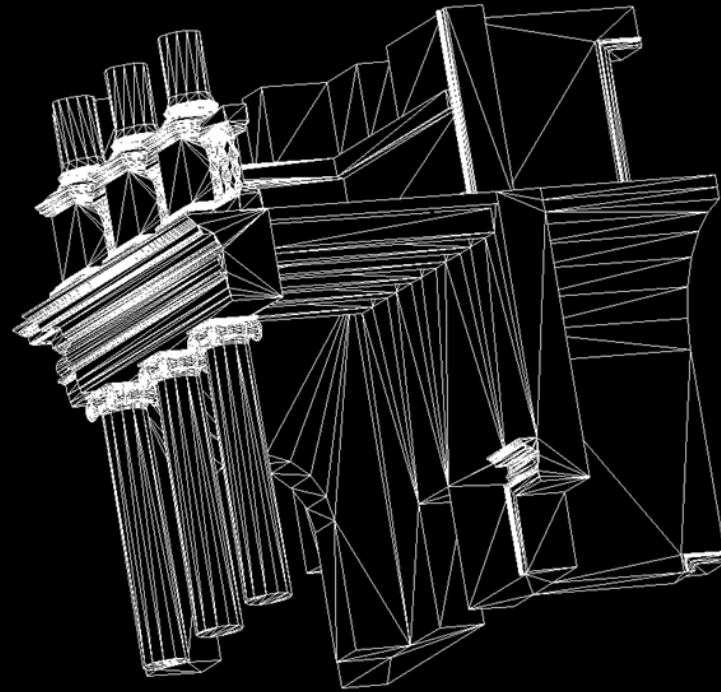

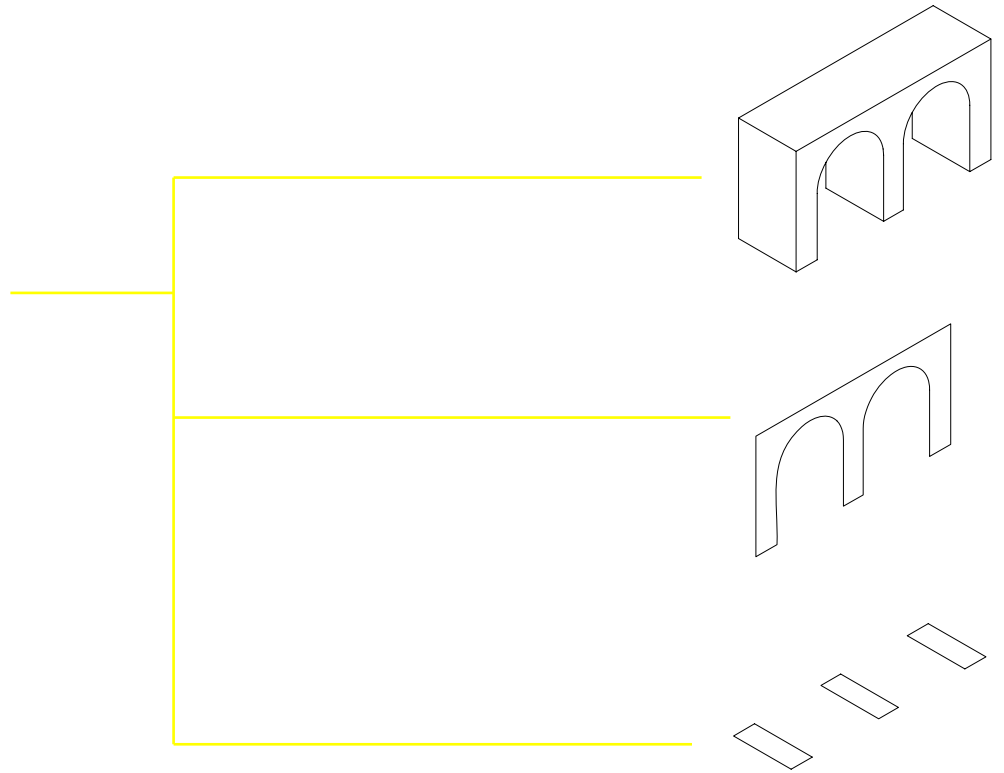
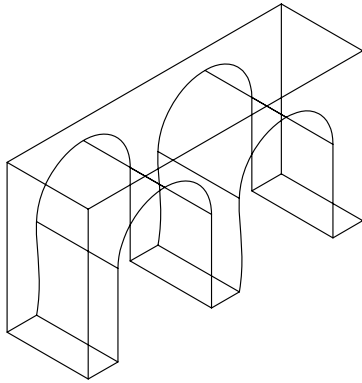

[3]  
Background

## History of Solid Modeling

- Computer Models were used in Architectural Research in – 1980s
- Computer Models used to create renderings – 1990s
- Computer Models will be used a the building source – 2000 – 2015

[4]  
Modeling Functions