

Applications of Diffraction

Outline

- Interference
- Diffraction
- Examples:
 - . Diffraction Gratings
 - . Photonic Crystals
 - . Interference Lithography
- Holography

Oil on Water

“I fetched out a cruet of oil and dropped a little of it on the water. I saw it spread itself with surprising swiftness upon the surface... Though not more than a teaspoonful, produced an instant calm over a space several yards square which spread amazingly and extended itself gradually till it reached the lee side, making all that quarter of the pond, perhaps half an acre, as smooth as a looking glass.”

“After this I contrived to take with me, whenever I went into the country, a little oil in the upper hollow joint of my bamboo cane, with which I might repeat the experiment and I found it constantly to succeed.”

~ 1762 ~
Ben Franklin

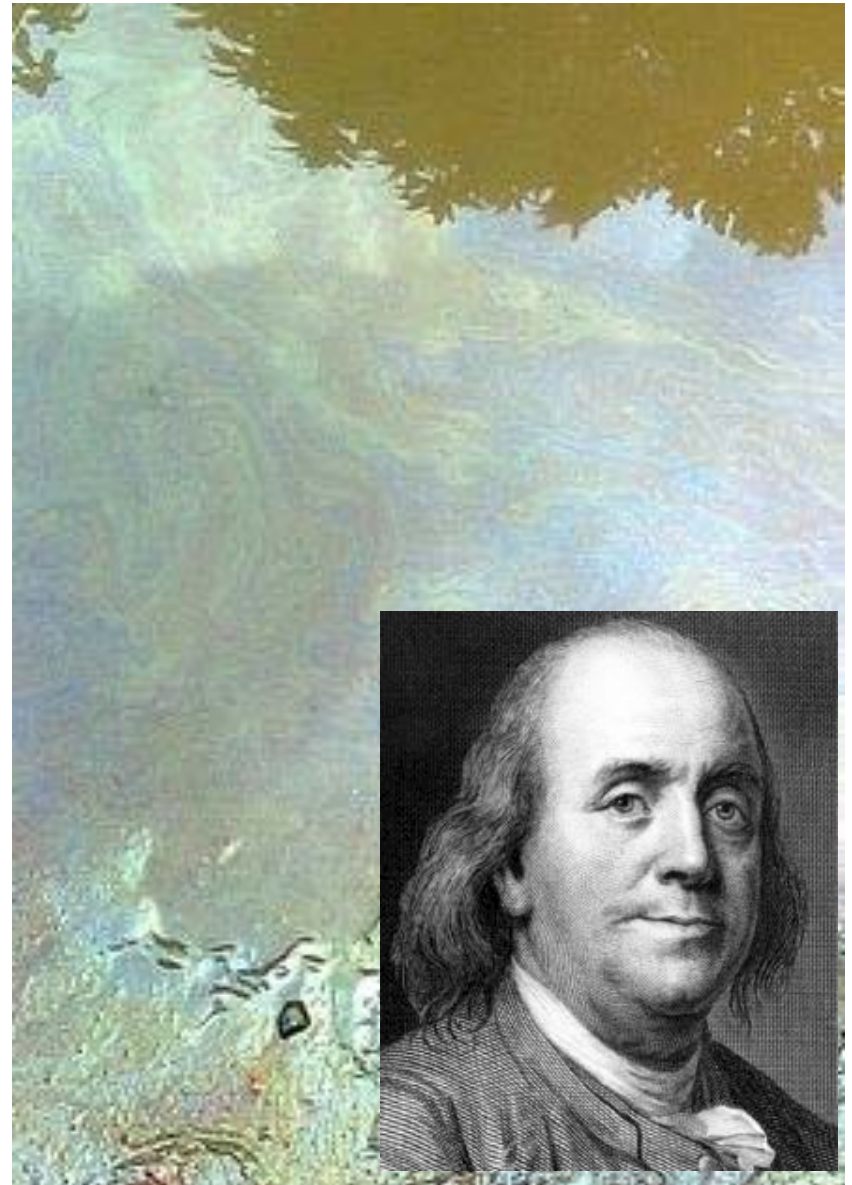
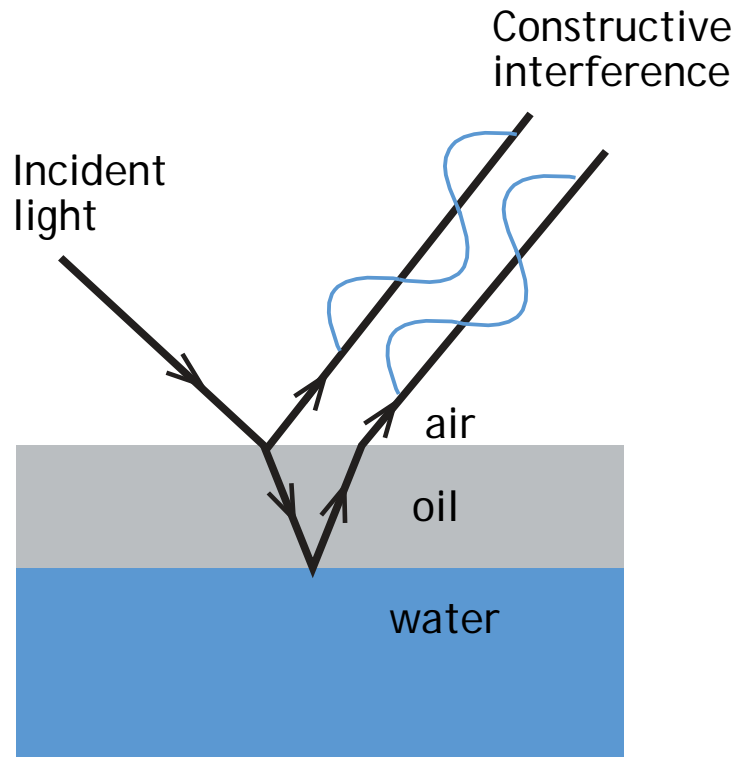

Image of Benjamin Franklin is in the public domain
Image of oil on water by ieshraq
<http://www.flickr.com/photos/ieshraq/4221707518/> on flickr

Thin Film Interference



Lord Rayleigh (1842 -1919) Repeated Franklin's oil on water experiment in 1890 and made a calculation of the thickness of the oil layer.

$$\begin{aligned} \text{teaspoonful of oil} &\div \text{half an acre of pond} \\ &= 2.4 \text{ nm} \end{aligned}$$



Image of Lord Rayleigh is in the public domain

Image of oil on water by Yoko Nekonomania
<http://www.flickr.com/photos/nekonomania/4827035737/>
on flickr

Diffraction of Light From Periodic Slit Source

DOUBLE SLIT DIFFRACTION WITH SLITS OF
DIFFERENT SEPARATION

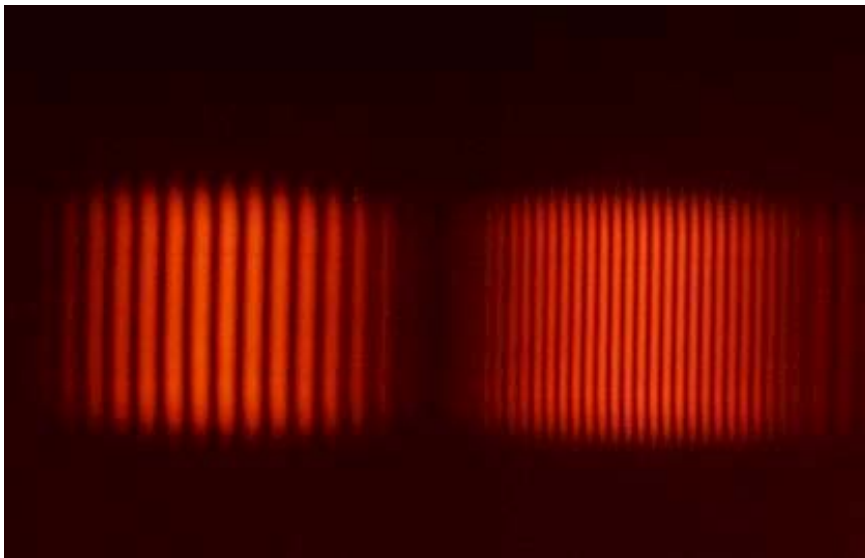
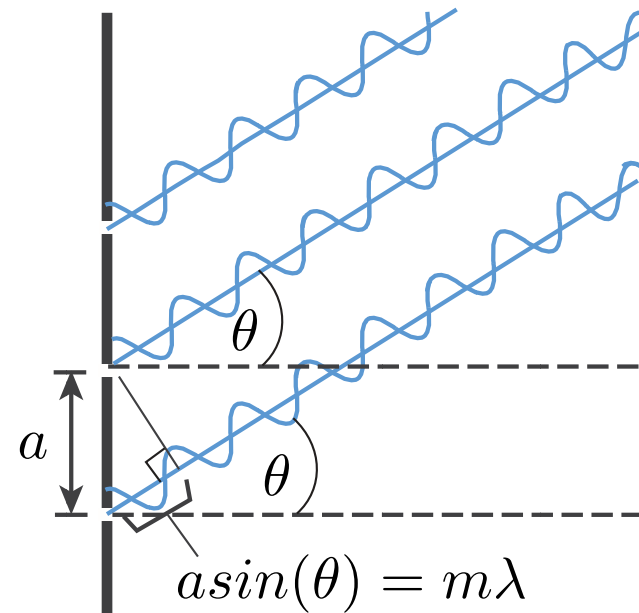
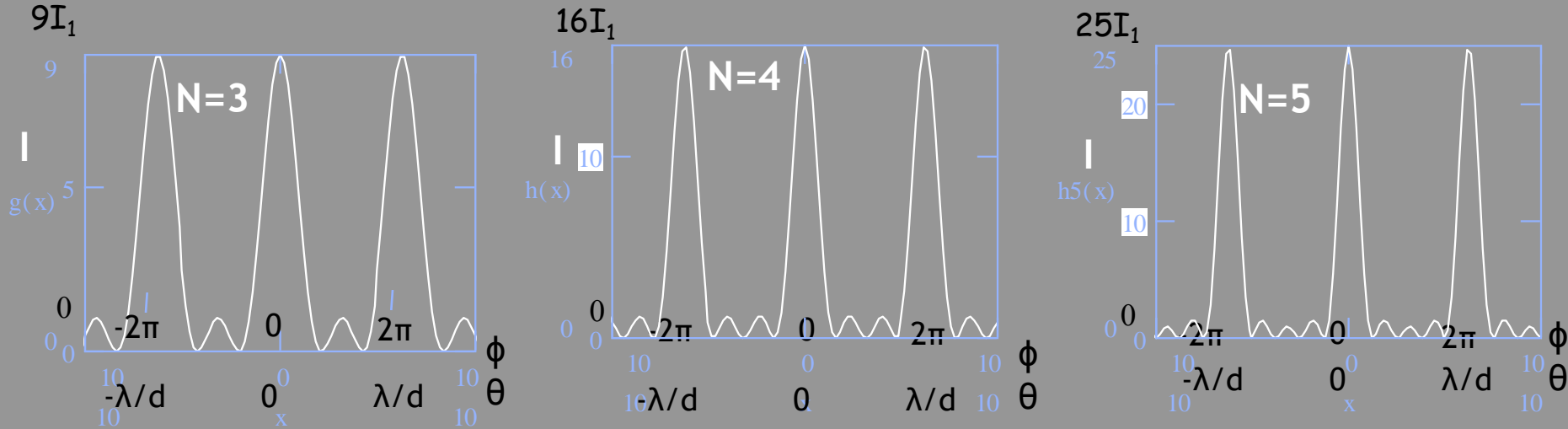

Image is in the public domain



Maxima in the intensity occur if this path length difference is an integer number of wavelengths.

Diffraction of Light From Multiple Slits



The positions of the principal maxima occur at $\phi = 0, \pm 2\pi, \pm 4\pi, \dots$ where ϕ is the phase between adjacent slits.

The intensity at the peak of a principle maximum goes as N^2 .

3 slits: $A_{\text{tot}} = 3A_1 \rightarrow I_{\text{tot}} = 9I_1$. N slits: $I_N = N^2I_1$.

Between two principle maxima there are $N-1$ zeros and $N-2$ secondary maxima \rightarrow The peak width $\sim 1/N$.

The total integrated power for a principle maximum goes as $N^2(1/N) = N$.

Application of Diffraction Gratings in Spectrometers

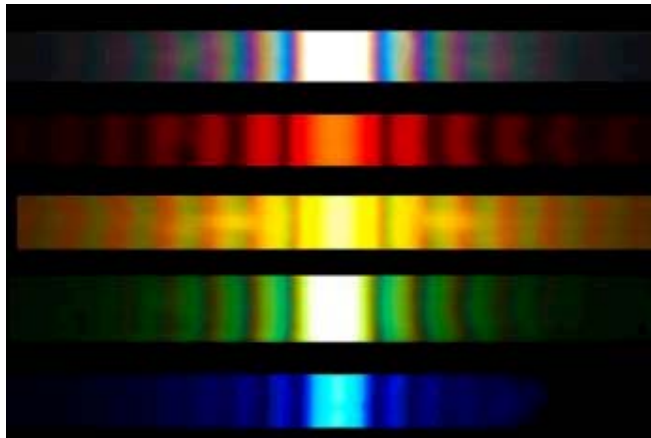
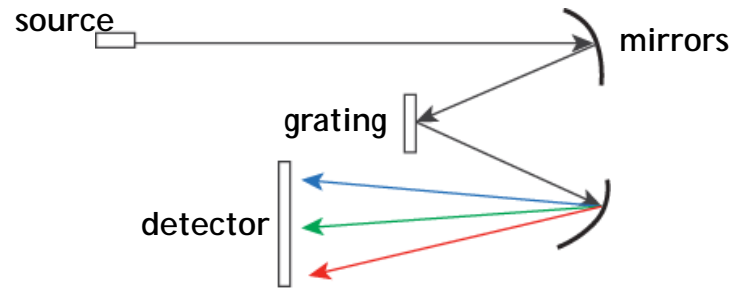
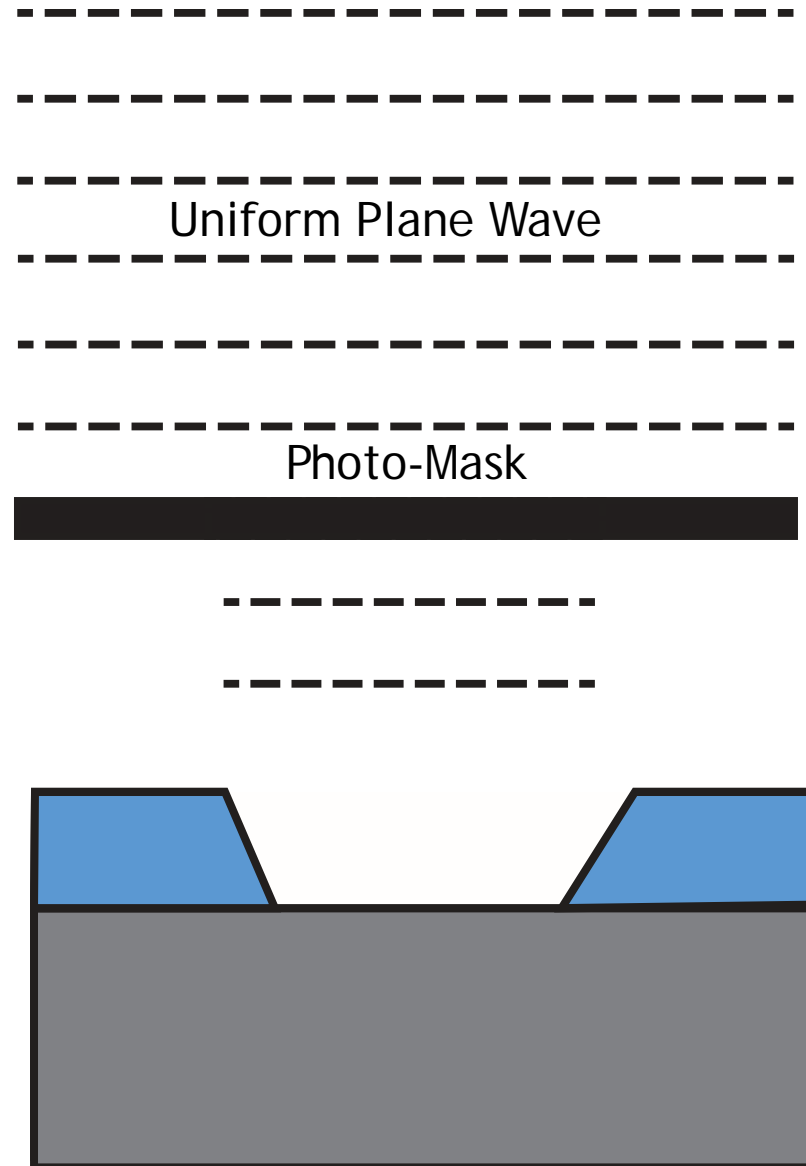
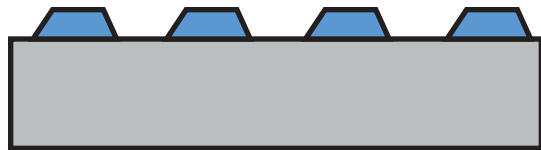

Image is in the public domain

*Making Diffraction Gratings
via Photolithography*



Making Diffraction Gratings

A lithographic technique is often used to produce diffraction gratings. This method relies on the interference pattern between two plane wave light sources. The grating period can be changed by changing the angle between the two.

$$P = \frac{\lambda}{2 \sin \theta}$$

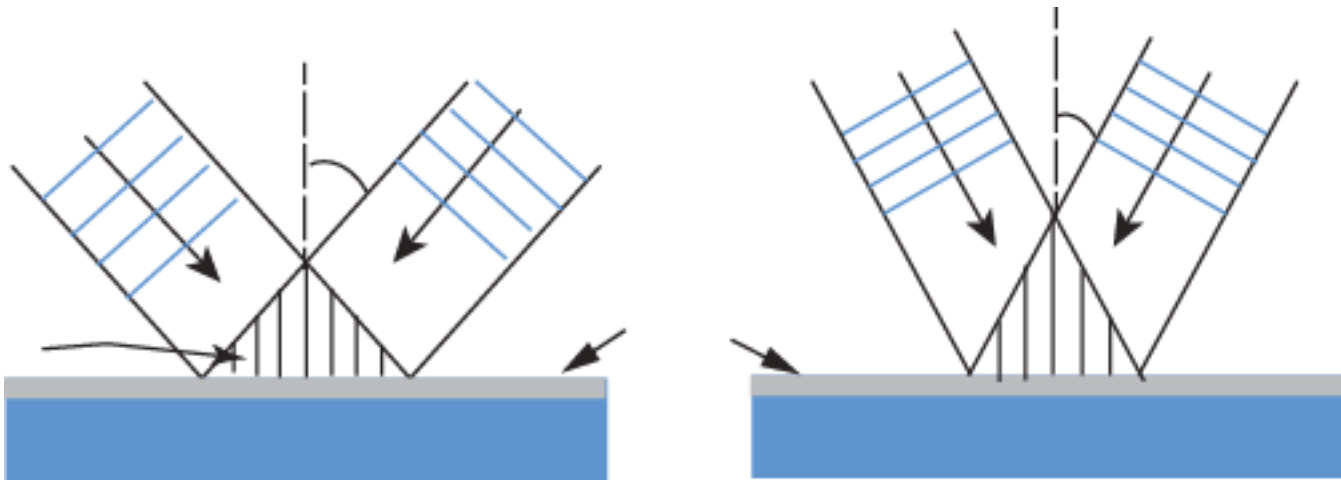

Natural Diffraction Gratings

Structural color: color arising from the diffraction of light by the surfaces and interference in an object, rather than from any absorption of light by pigments.

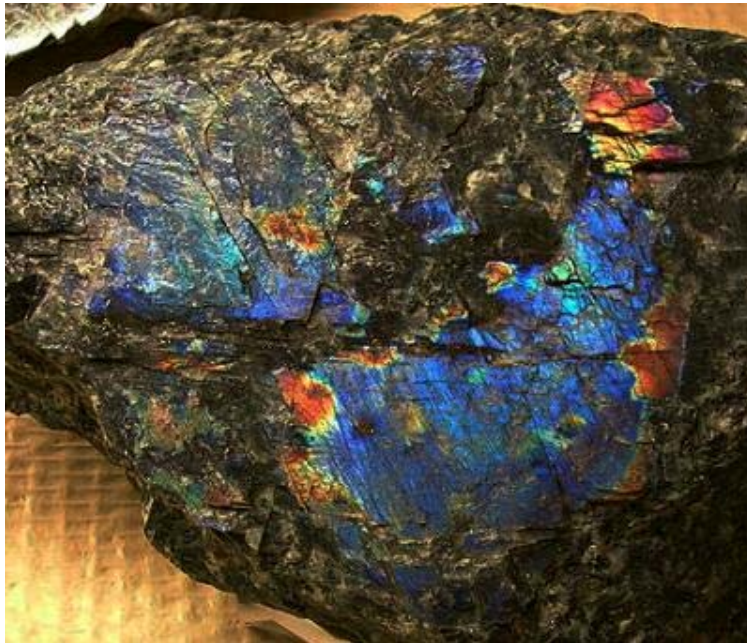

Image by Shyamal
[http://commons.wikimedia.org/wiki/
File:LabradoriteOslo.jpg](http://commons.wikimedia.org/wiki/File:LabradoriteOslo.jpg) on Wikimedia commons

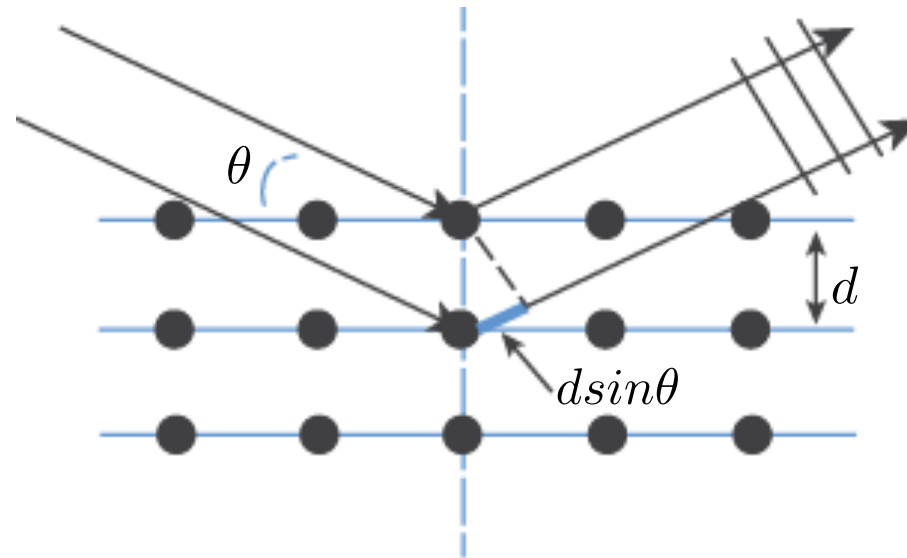

Image by Geoff Gallice
[http://www.flickr.com/photos/
11014423@N07/5596526523](http://www.flickr.com/photos/11014423@N07/5596526523) on flickr

Applications of Diffraction

X-ray Crystallography

The incoming beam (coming from upper left) causes each scatterer to re-radiate a small portion of its energy as a spherical wave. If scatterers are arranged symmetrically with a separation d , these spherical waves will be in synch (add constructively) only in directions where their path-length difference $2d \sin \theta$ equals an integer multiple of the wavelength λ . In that case, part of the incoming beam is deflected by an angle 2θ , producing a reflection spot in the diffraction pattern.



Diffraction of Light a DVD

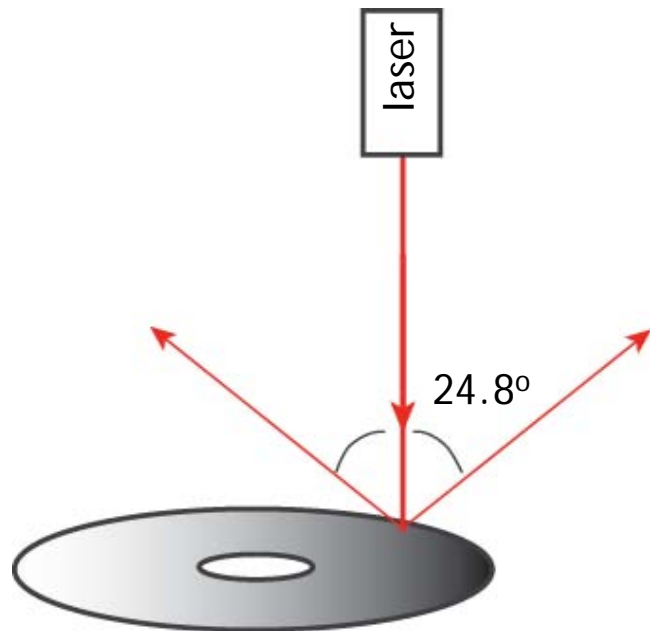

$$a \sin \theta = m\lambda$$

CD/DVD surface acts like a diffraction grating

How much information can the CD store?

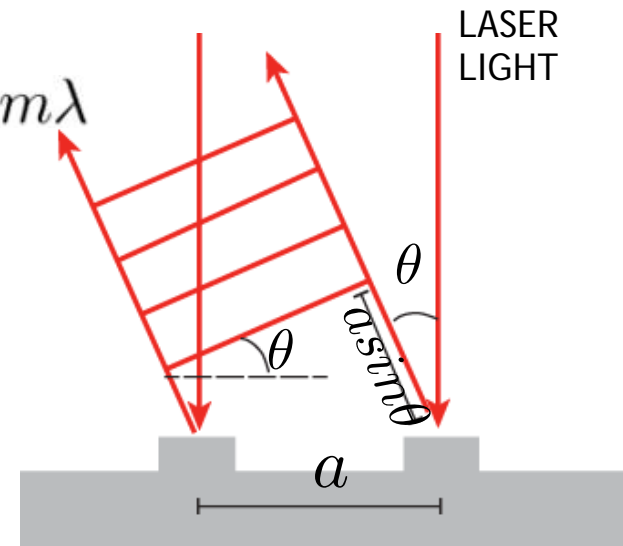

2 BUMPS on a CD/DVD SURFACE
are DISTANCE a APART

Conventional vs. Holographic Photography

■ Conventional:

- Records only intensity $|E_O|^2$
- 2-d version of a 3-d scene
- Photograph lacks depth perception or parallax
- Phase relation (i.e. interference) are lost

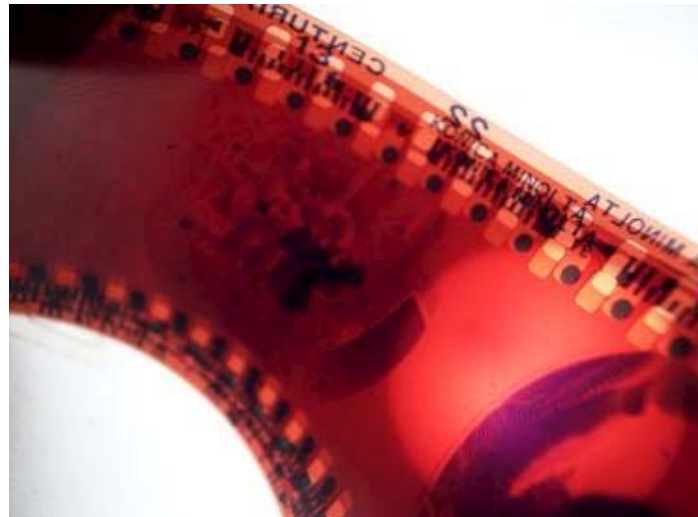

Image by live-14zawa
<http://www.flickr.com/photos/livegym/306473531/> on flickr

Conventional vs. Holographic Photography

■ Hologram:

- Freezes the intricate wavefront of light that carries all the visual information of the scene including amplitude and phase
- To view a hologram, the wavefront is reconstructed
- View what we would have seen if present at the original scene through the window defined by the hologram
- Provides depth perception and parallax



Holography: Interference Photography

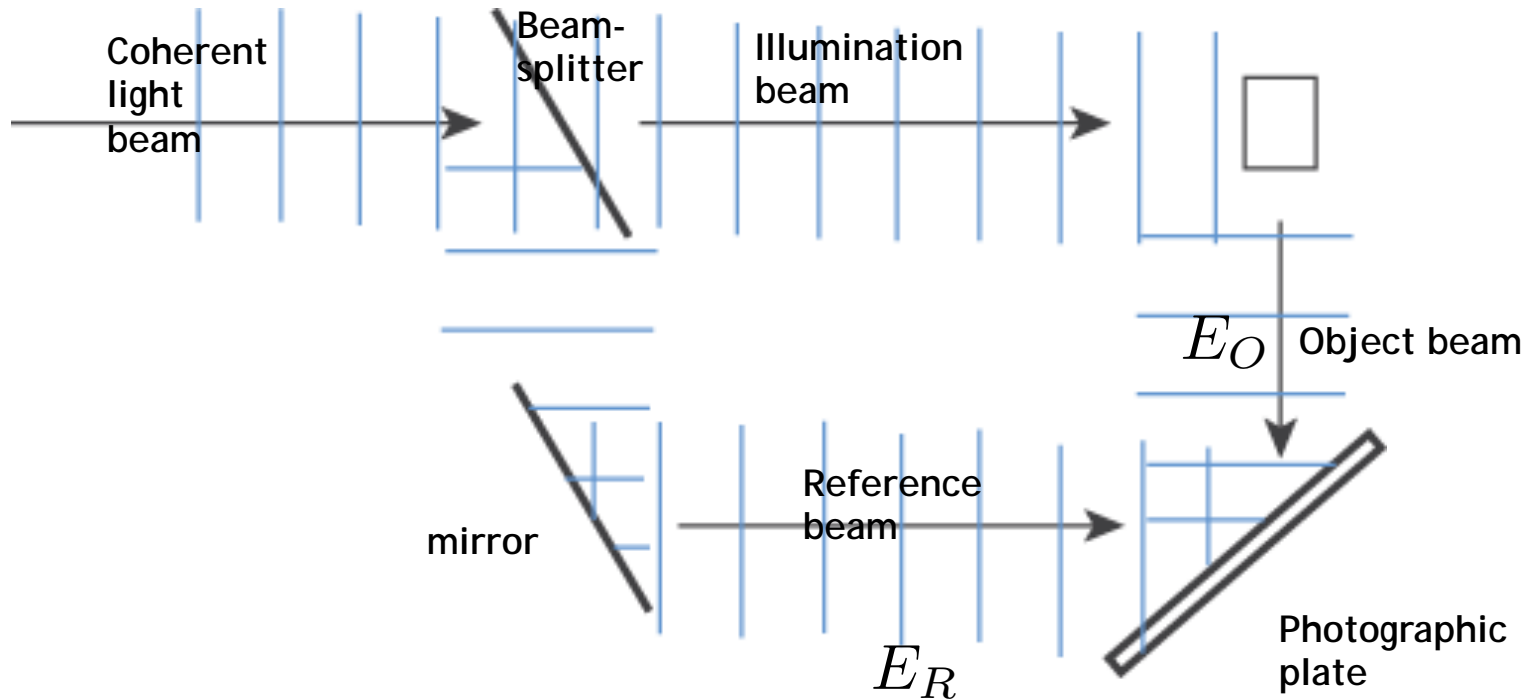

Intensity of light on the photographic plate

$$|E_O + E_R|^2 = E_O E_R^* + |E_R|^2 + |E_O|^2 + E_O^* E_R$$

Holography: Interference Photography

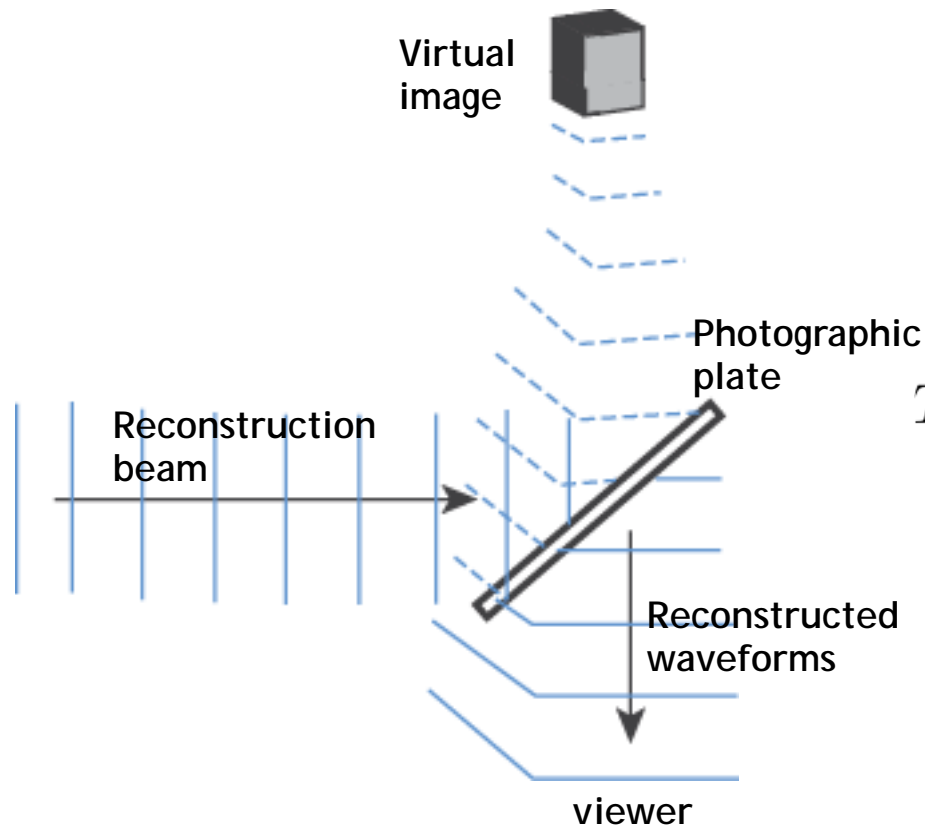

If a photographic plate is exposed to the two beams, and then developed, its transmittance, T , is proportional to the light energy which was incident on the plate, and is given by

$$T = s[E_O E_R^* + |E_R|^2 + |E_O|^2 + E_O^* E_R]$$

where s is a constant.

When the developed plate is illuminated by the reference beam, the light transmitted through the plate, $E_{\text{VIEWER}} = T^* E_R$ is:

$$\begin{aligned} E_{\text{Viewer}} &= E_R T = s[E_O E_R^* + |E_R|^2 + |E_O|^2 + E_O^* E_R] E_R \\ &= s[E_O + |E_R|^2 E_R + |E_O|^2 E_R + E_O^* E_R^2] \end{aligned}$$

Holographic Movie Projection

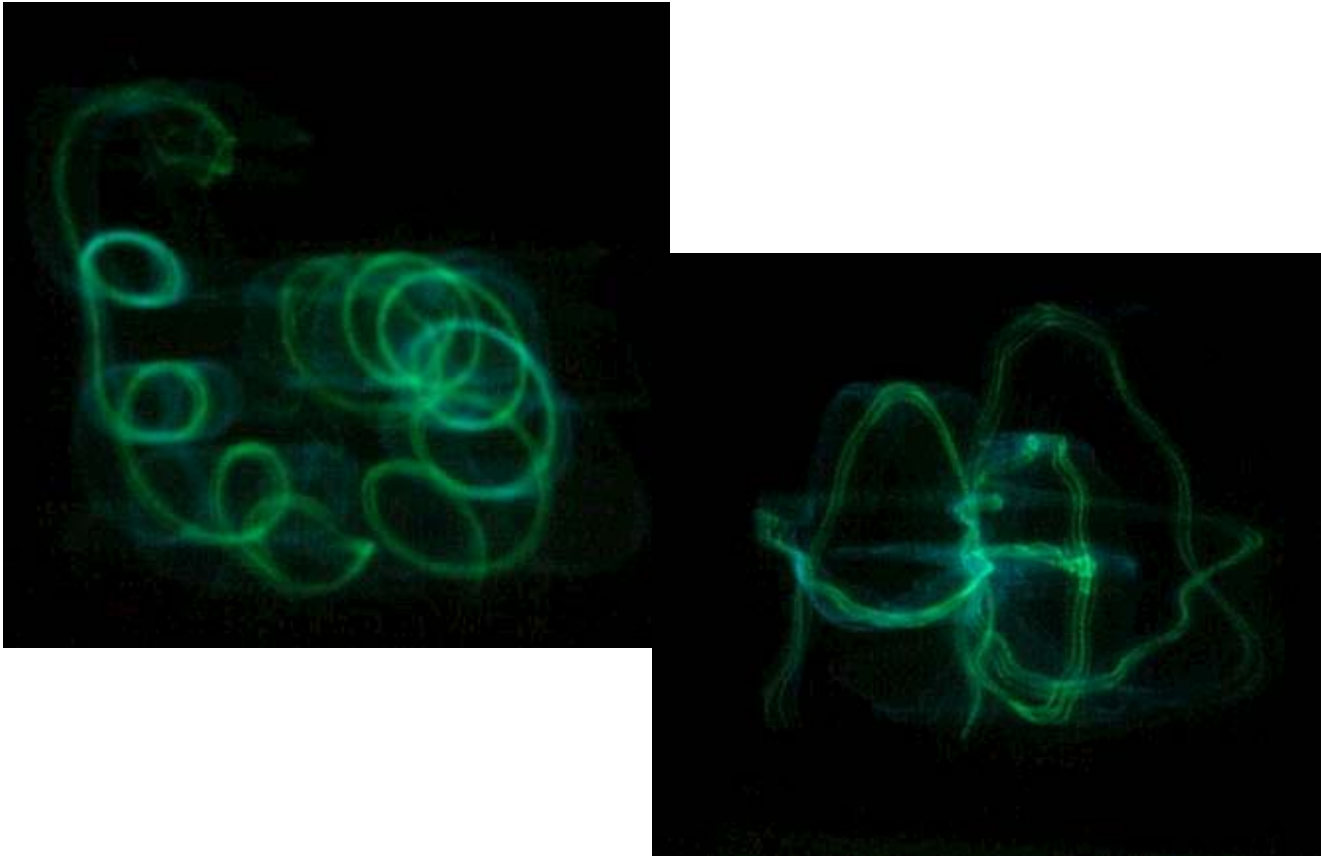

Images by Hologlyphics
<http://www.flickr.com/photos/hologlyphics/2497672716/>
on flickr

MIT OpenCourseWare
<http://ocw.mit.edu>

6.007 Electromagnetic Energy: From Motors to Lasers
Spring 2011

For information about citing these materials or our Terms of Use, visit: <http://ocw.mit.edu/terms>.