

MIT EECS 6.837

Computer Graphics

Wojciech Matusik

A cartoon has been removed due to copyright restrictions.

Real-Time Shadows

Why are Shadows Important?

- Depth cue
- Scene Lighting
- Realism
- Contact points

Image removed due to copyright restrictions.

Shadows as a Depth Cue

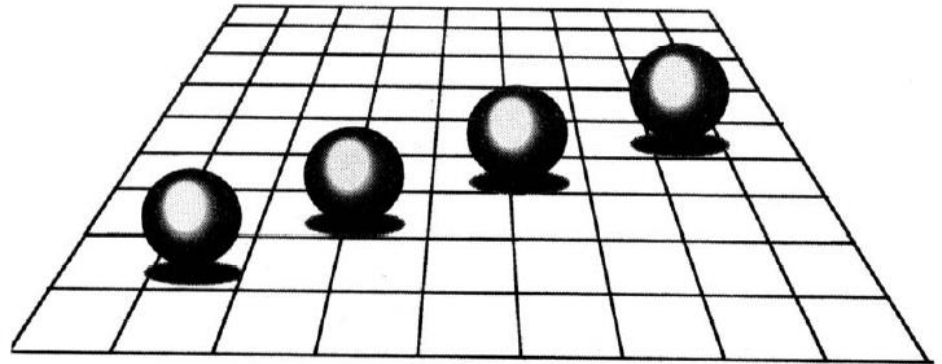
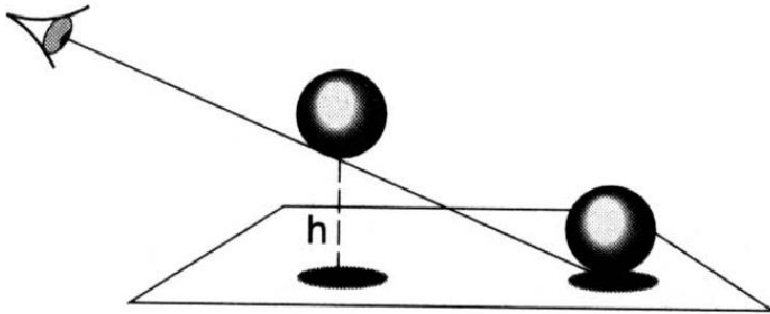

A

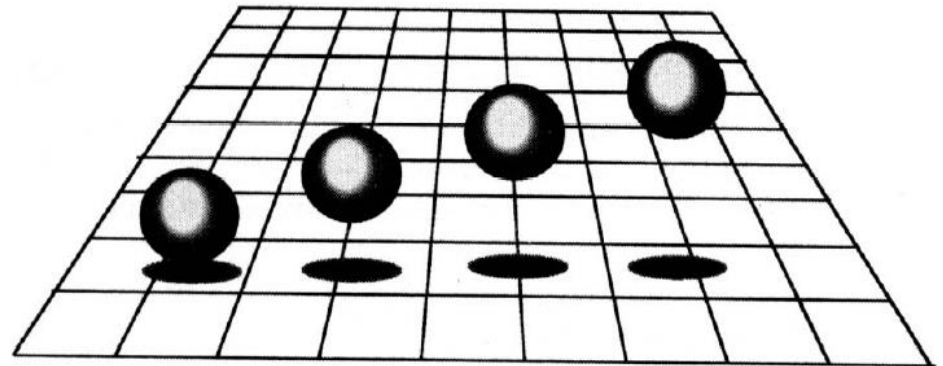

© source unknown. All rights reserved. This content is excluded from our Creative Commons license. For more information, see <http://ocw.mit.edu/help/faq-fair-use/>.

Shadows as the Origin of Painting



© source unknown. All rights reserved. This content is excluded from our Creative Commons license. For more information, see <http://ocw.mit.edu/help/faq-fair-use/>.

This image is in the public domain. Author: David Allan (!744-1796).

Shadow in Ray Tracing

- Trace secondary (shadow) rays towards each light source
- If the closest hit point is smaller than the distance to the light then the point is in shadow

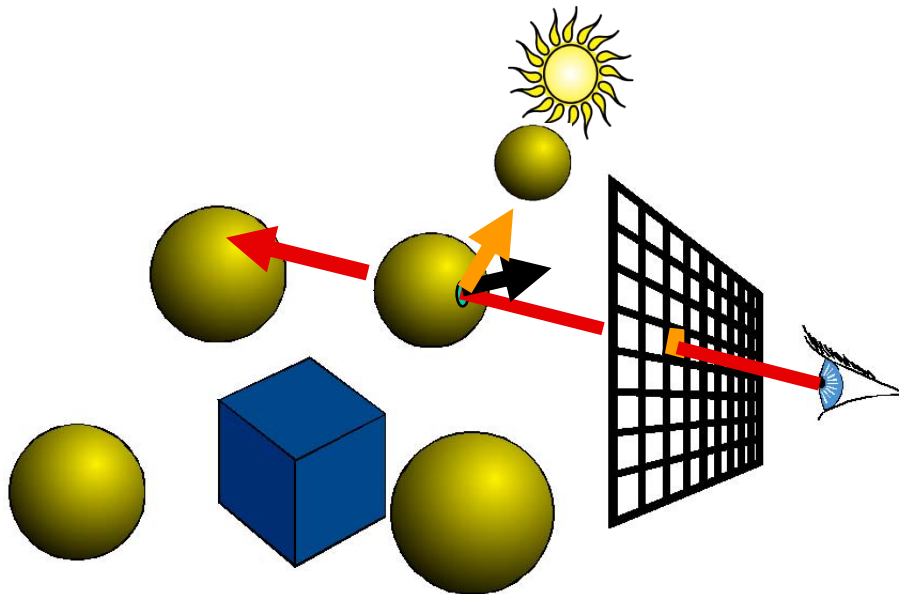

Today

- **Shadow Maps**
 - Shadow/View Duality
 - Texture Mapping
- Shadow Volumes
- Deep Shadow Maps
- Alias-free Shadow Maps

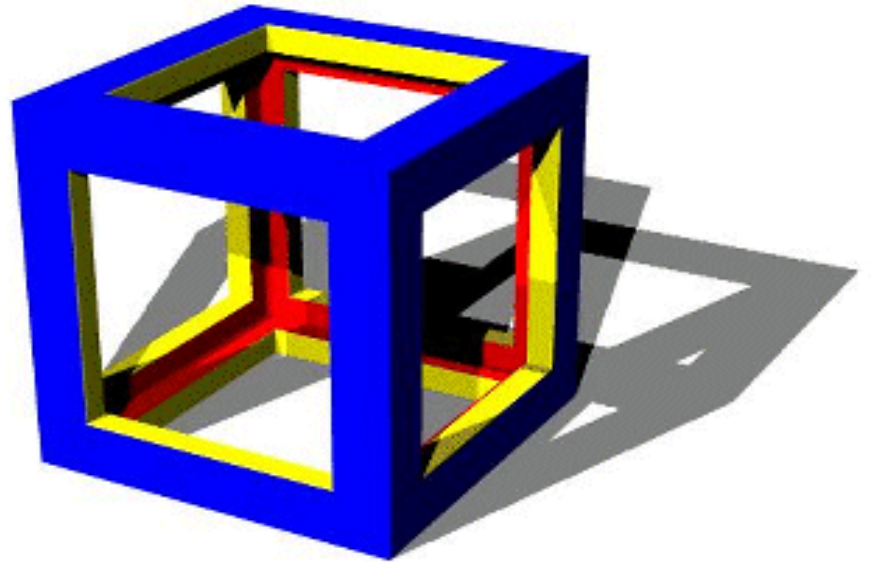

Shadow Maps Are Important

- Both in high-end production software...
 - Pixar's RenderMan
- ... and in real-time rendering (e.g. games)



© Pixar. All rights reserved. This content is excluded from our Creative Commons license. For more information, see <http://ocw.mit.edu/help/faq-fair-use/>.

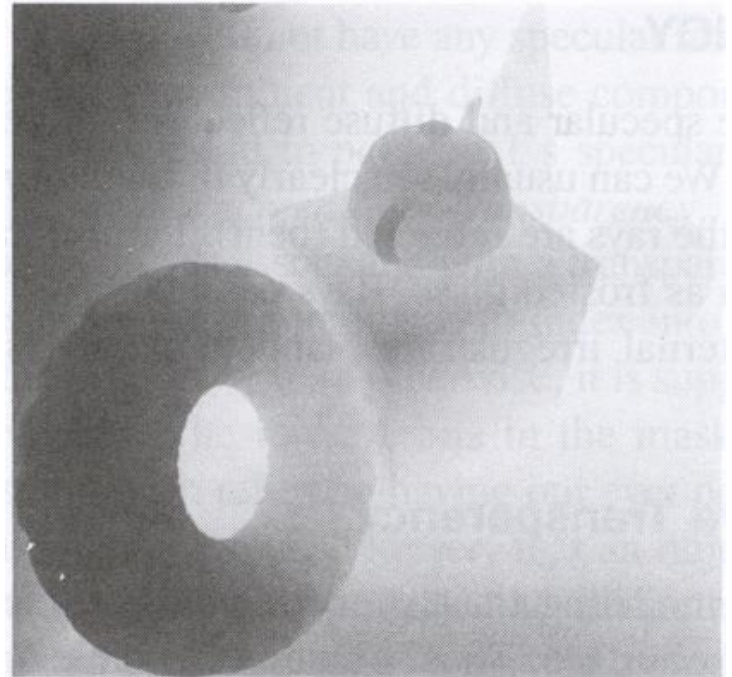

© source unknown. All rights reserved. This content is excluded from our Creative Commons license. For more information, see <http://ocw.mit.edu/help/faq-fair-use/>.

Shadow/View Duality

- A point is lit if it is visible from the light source

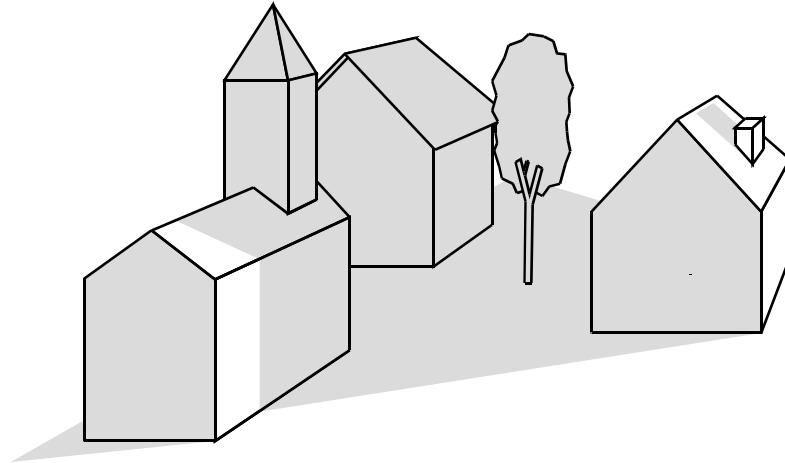

- Shadow computation similar to view computation

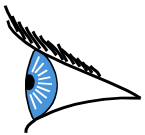
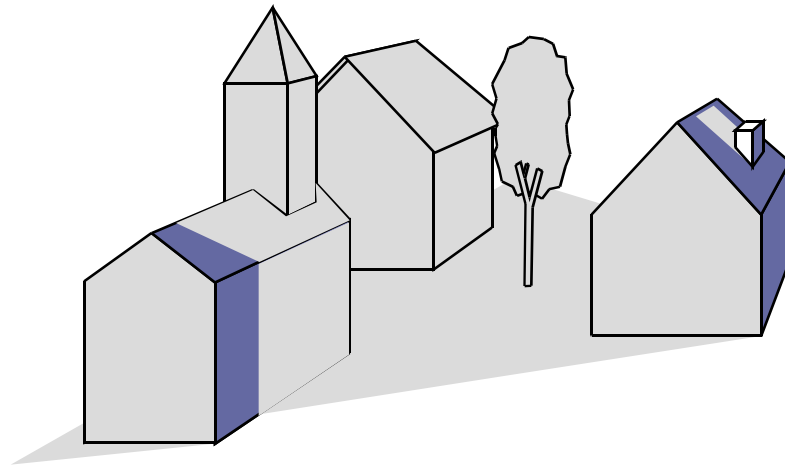

Shadow Mapping

- Texture mapping with depth information
- 2 passes
 - Compute shadow map == depth from light source
 - You can think of it as a z-buffer as seen from the light
 - Render final image, check shadow map to see if points are in shadow

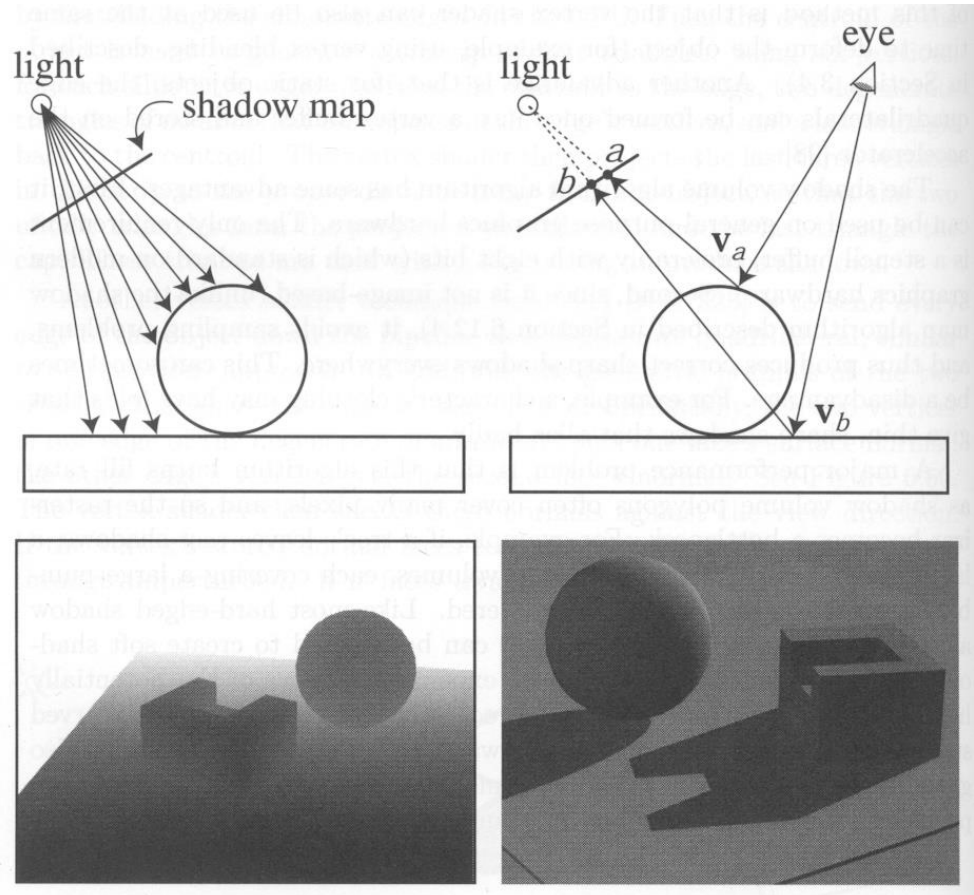

© Addison-Wesley. All rights reserved. This content is excluded from our Creative Commons license. For more information, see <http://ocw.mit.edu/help/faq-fair-use/>.

Foley et al. "Computer Graphics Principles and Practice"

Shadow Map Look Up

- We have a 3D point $(x,y,z)_{WS}$

- How do we look up the depth from the shadow map?

- Use the 4x4 perspective projection matrix from the light source to get $(x',y',z')_{LS}$
- $\text{ShadowMap}(x',y') < z'$?

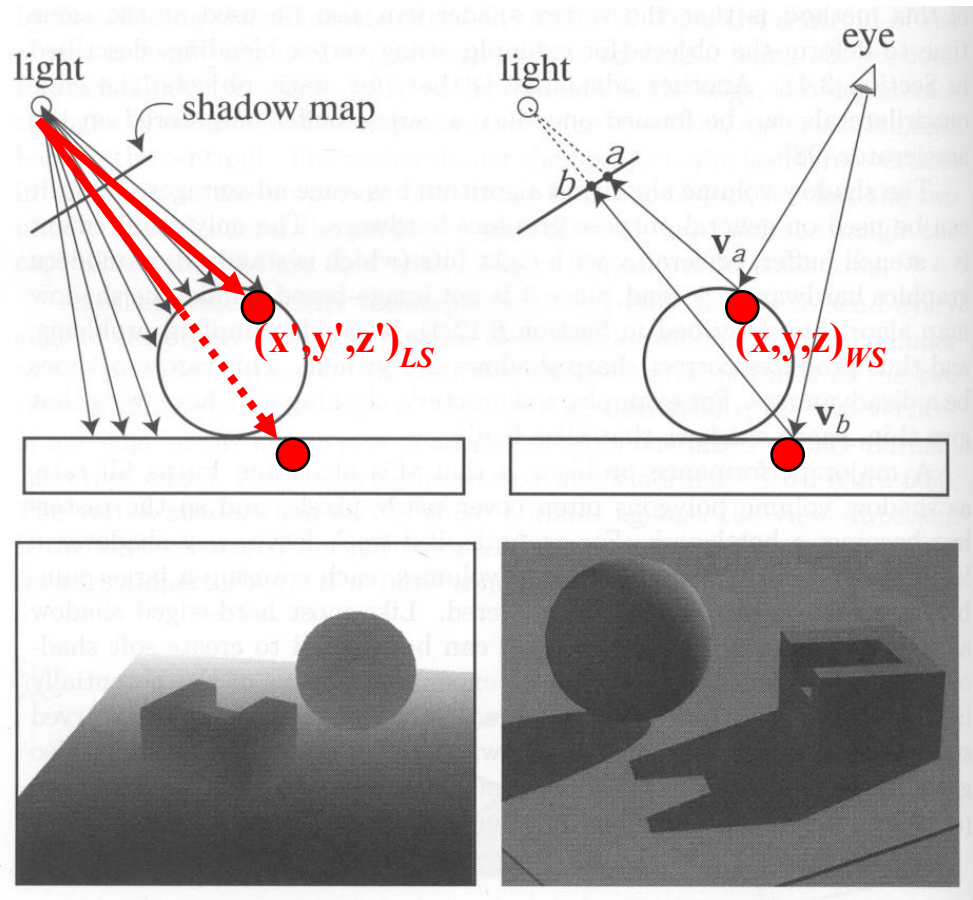

© Addison-Wesley. All rights reserved. This content is excluded from our Creative Commons license. For more information, see <http://ocw.mit.edu/help/faq-fair-use/>.

Shadow Map Look Up

Questions?

- We have a 3D point $(x,y,z)_{WS}$

- How do we look up the depth from the shadow map?

- Use the 4x4 perspective projection matrix from the light source to get $(x',y',z')_{LS}$
- $\text{ShadowMap}(x',y') < z'$?

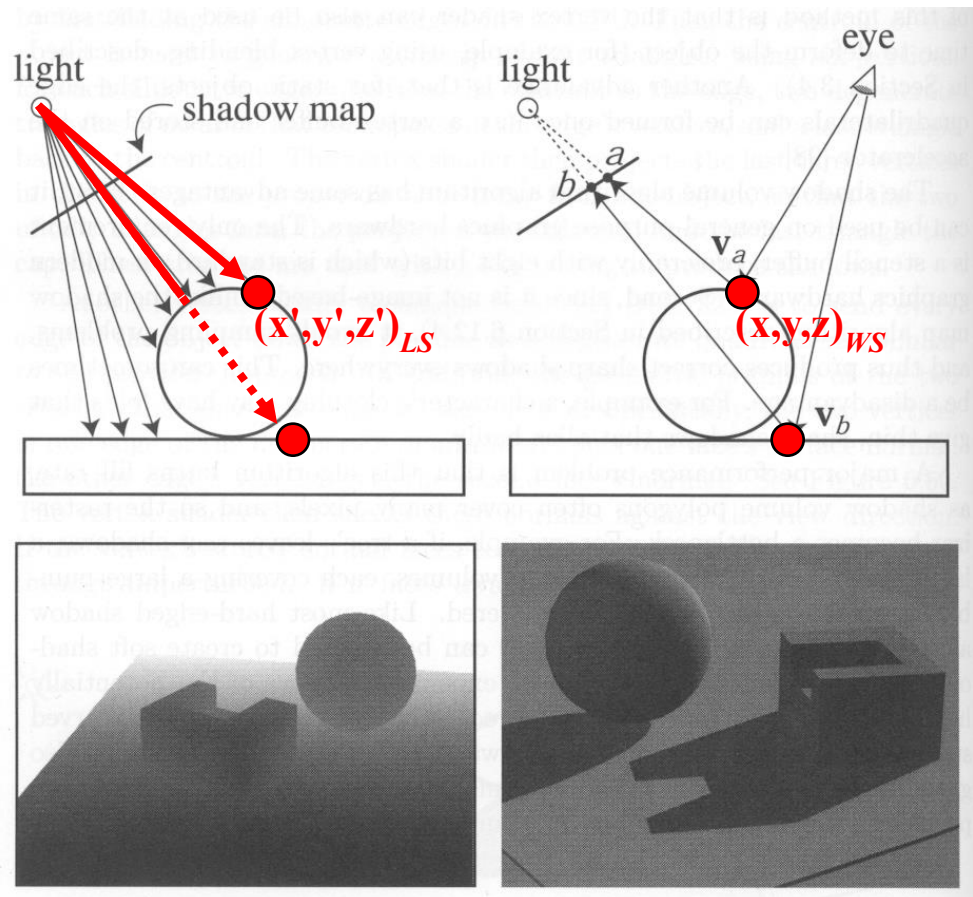

© Addison-Wesley. All rights reserved. This content is excluded from our Creative Commons license. For more information, see <http://ocw.mit.edu/help/faq-fair-use/>.

Limitations of Shadow Maps

1. Field of View
2. Bias (Epsilon)
3. Aliasing

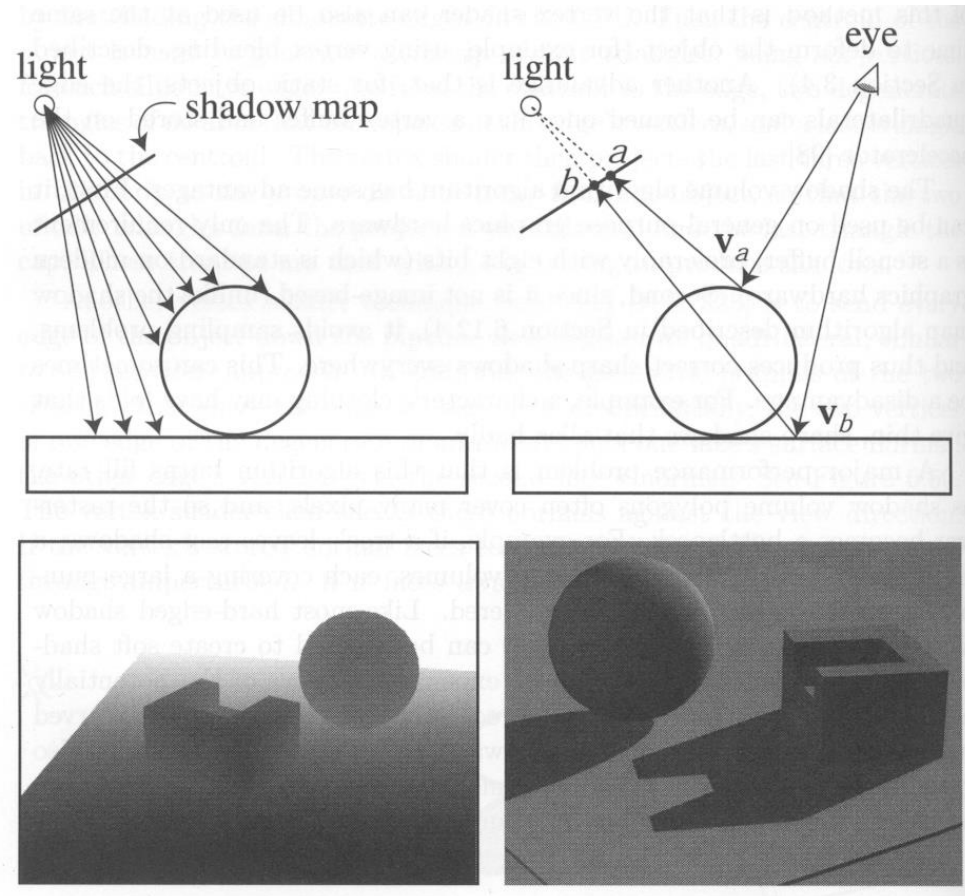

1. Field of View Problem

- What if point to shadow is outside field of view of shadow map?
 - Use 6 shadow maps on the faces of a cube
 - ... or use only spot lights

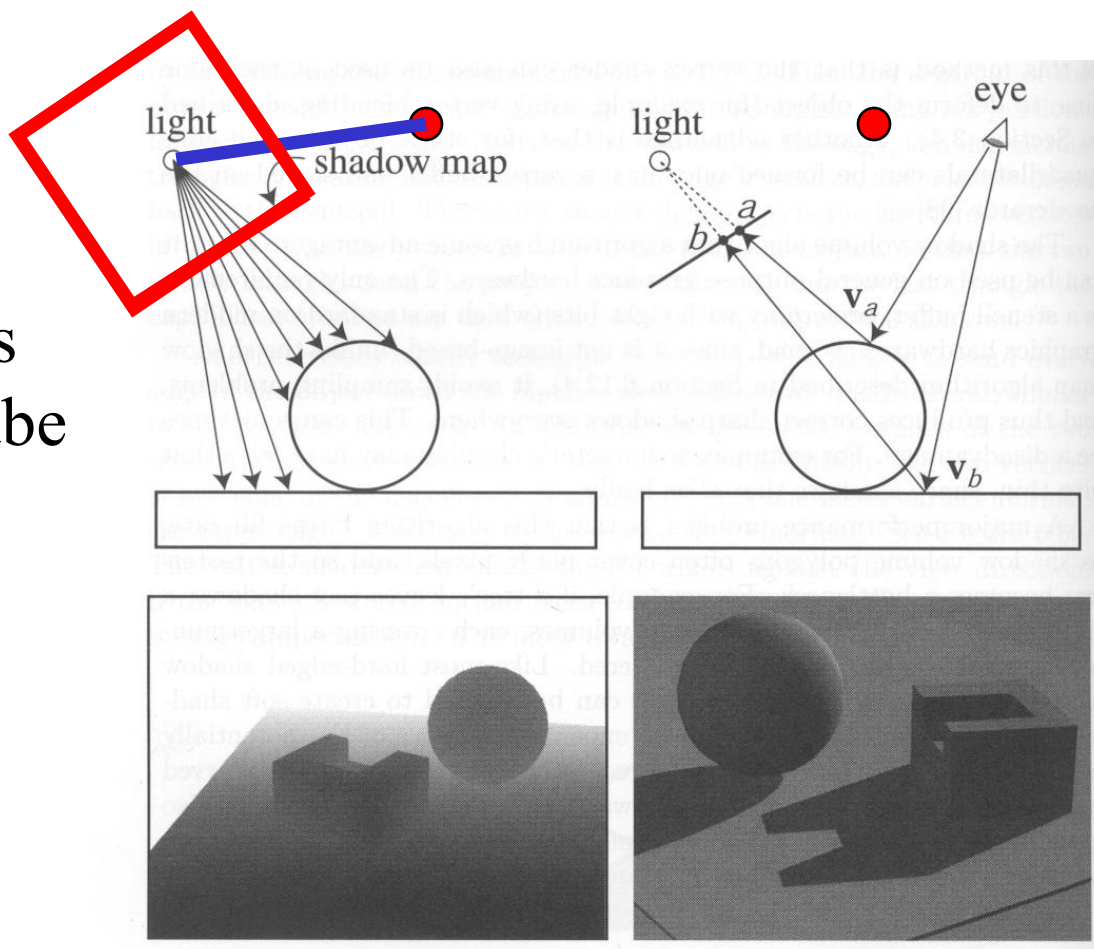

2. The Bias (Epsilon) Nightmare

- For a point visible from the light source
ShadowMap(x', y') $\approx z'$
 - But due to rounding errors the depths never agree exactly
- How can we avoid erroneous self-shadowing?
 - Add bias (epsilon)

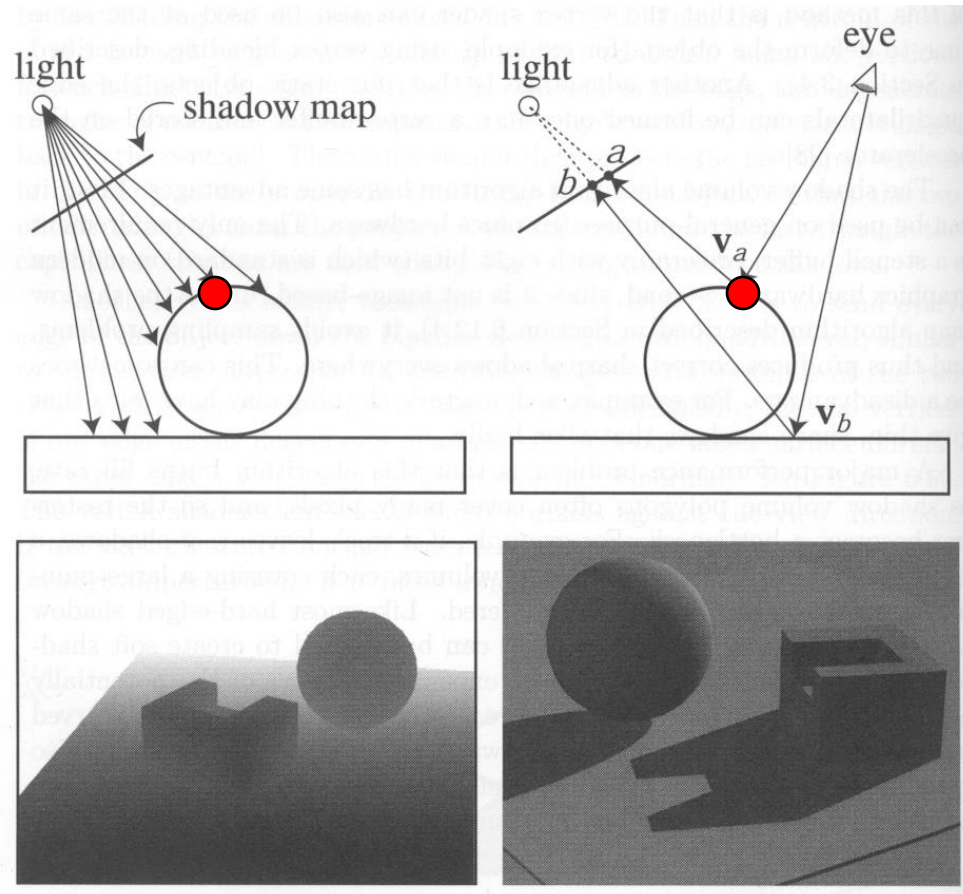

2. Bias (Epsilon) for Shadow Maps

$$\text{ShadowMap}(x', y') + \text{bias} < z'$$

Choosing a good bias value can be very tricky

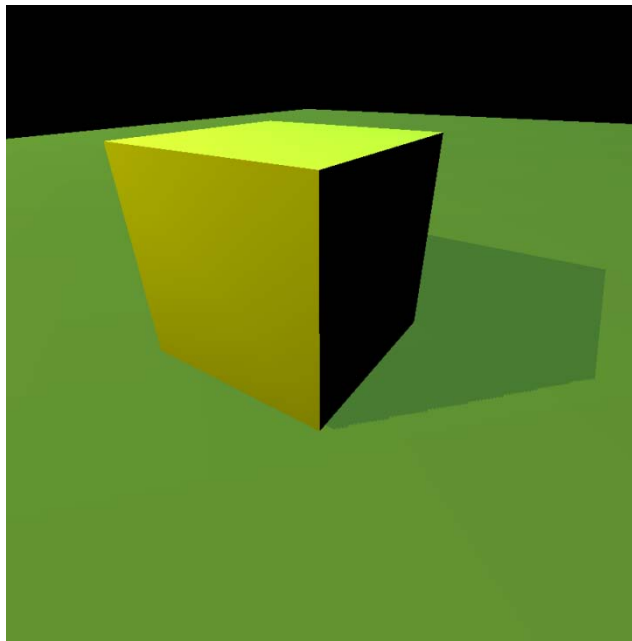

Correct image

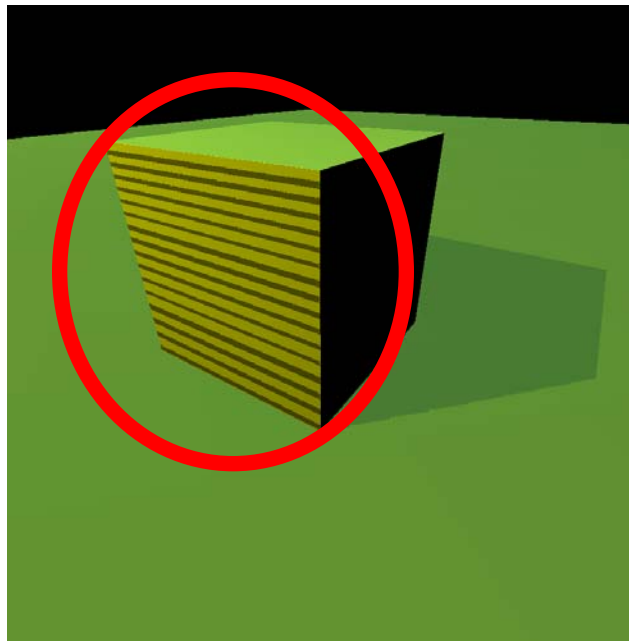

Not enough bias
("surface acne")

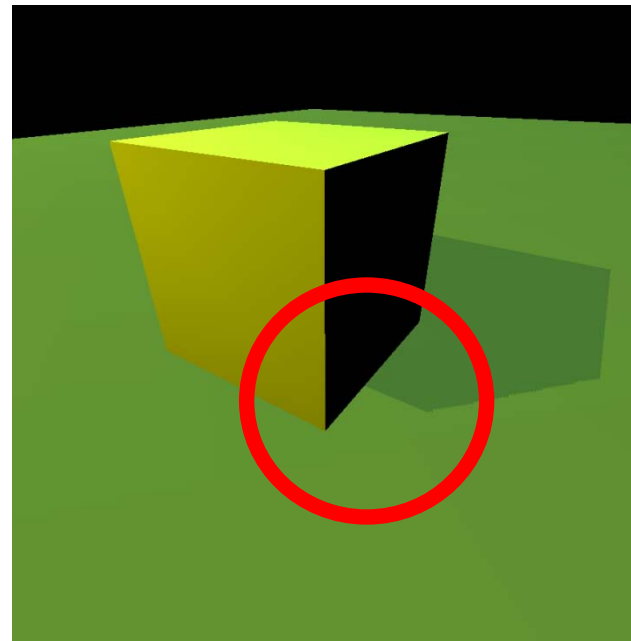

Way too much bias

3. Shadow Map Aliasing

- Under-sampling of the shadow map
 - Jagged shadow edges

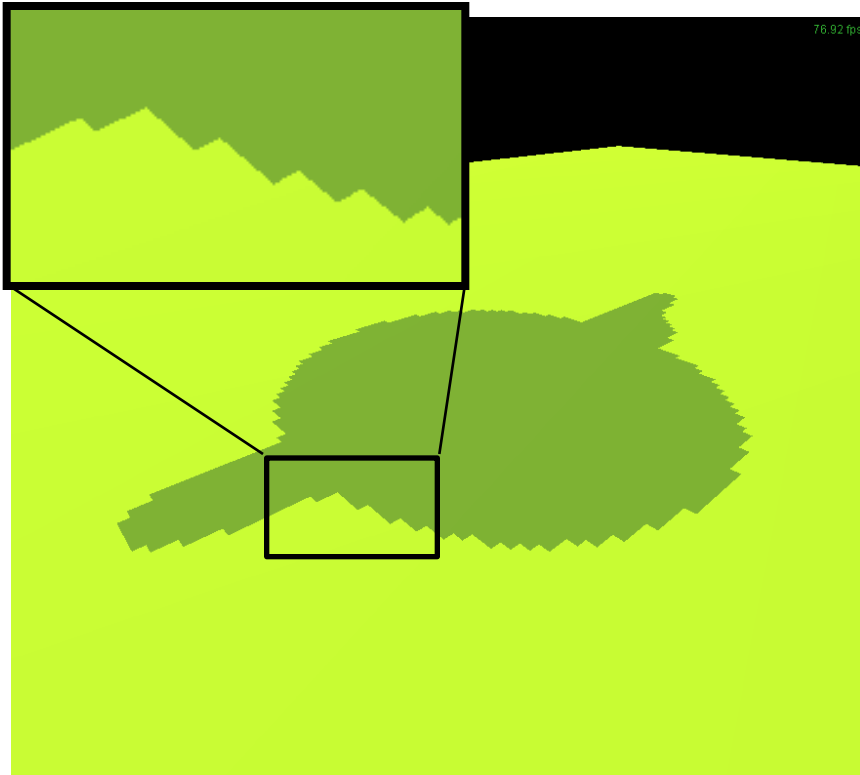

3. Shadow Map Filtering

- Should we filter the depth?
(weighted average of neighboring depth values)
- No... filtering depth is not meaningful

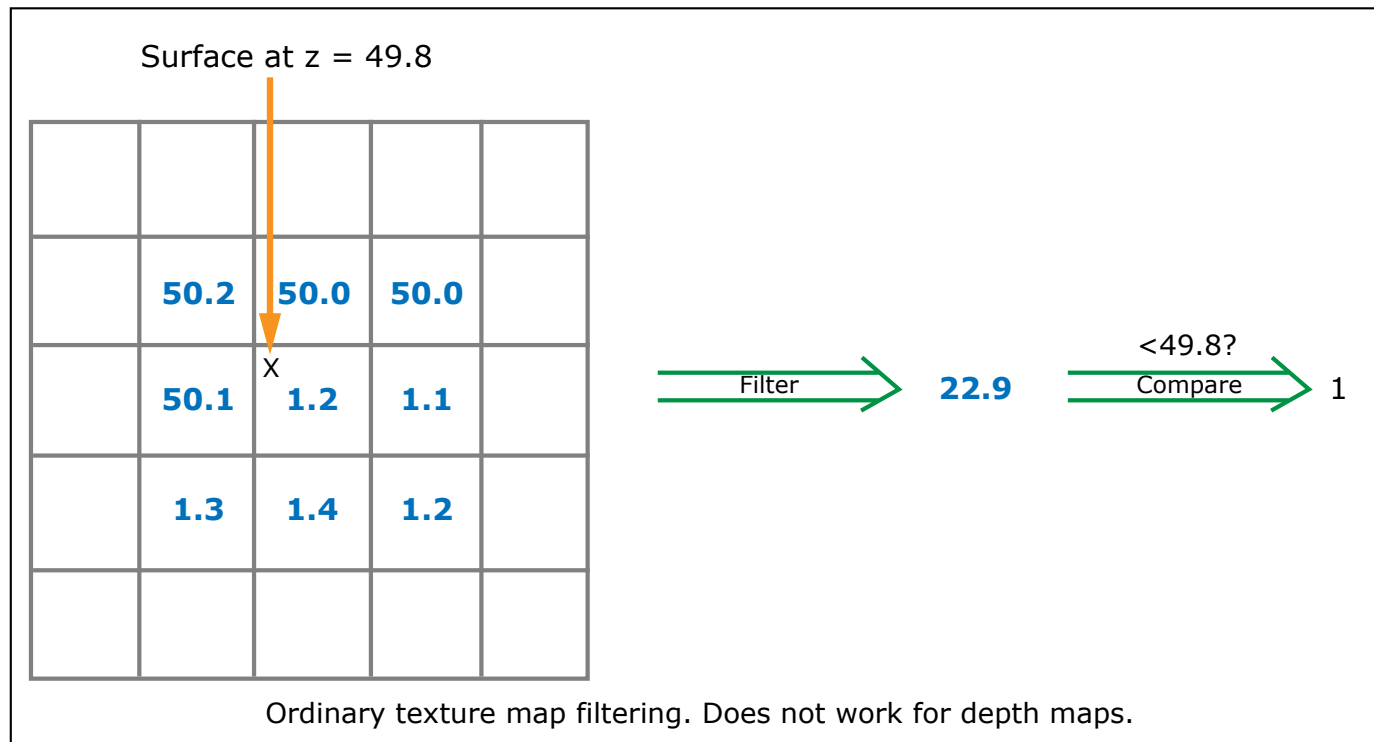

Image by MIT OpenCourseWare.

3. Percentage Closer Filtering

- Instead we need to filter the *result* of the shadow test (weighted average of comparison results)

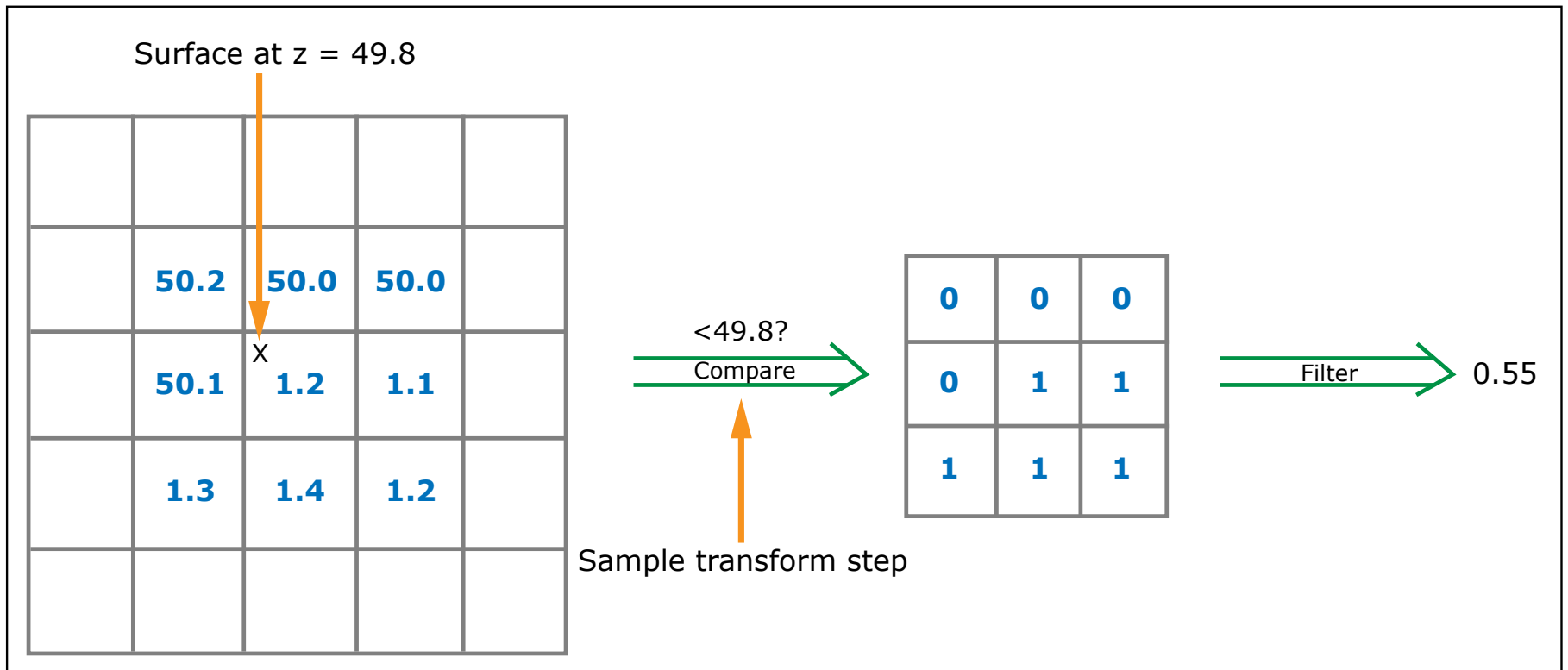

Image by MIT OpenCourseWare.

3. Percentage Closer Filtering

- 5x5 samples
- Nice antialiased shadow
- Using a bigger filter produces fake soft shadows
- Setting bias is tricky



3. Percentage Closer Filtering

- 5x5 samples
- Nice antialiased shadow
- Using a bigger filter produces fake soft shadows
- Setting bias is tricky



Questions?

Shadows in Production

- Often use shadow maps
- Ray casting as fallback in case of robustness issues

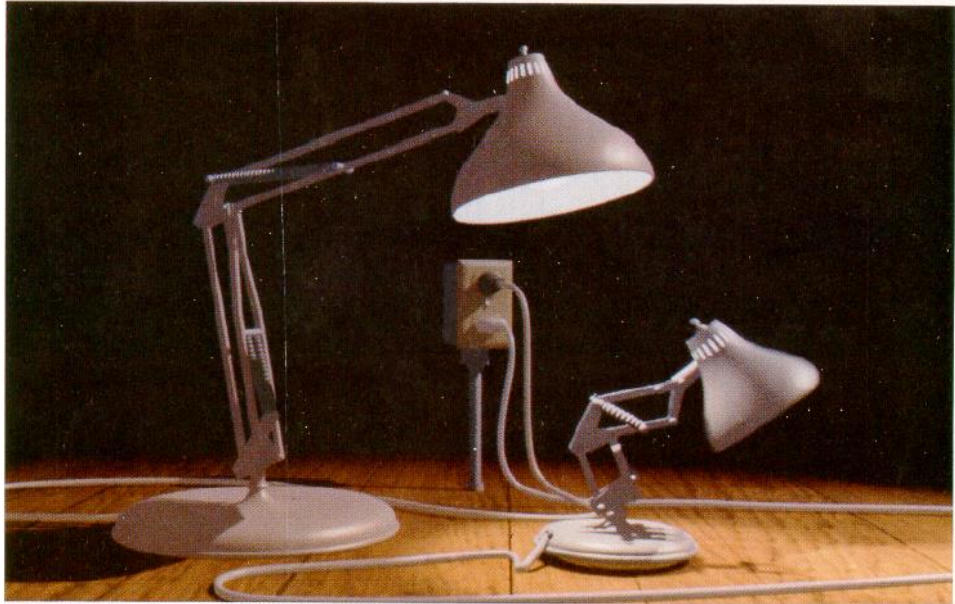

Figure 12. Frame from *Luxo Jr.*

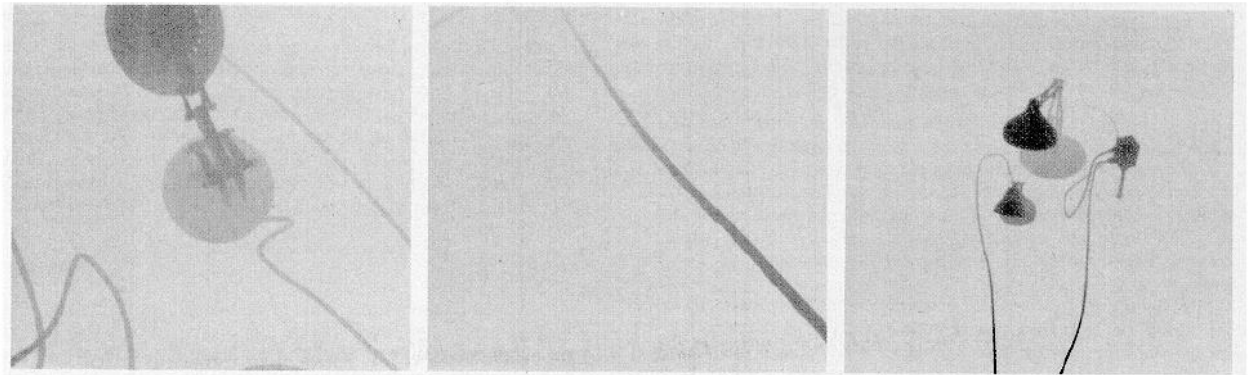
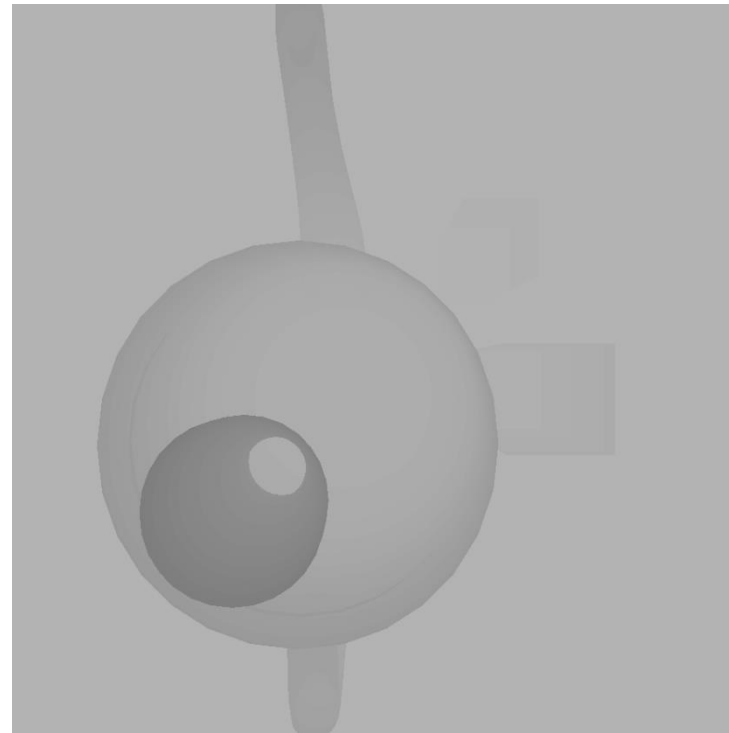
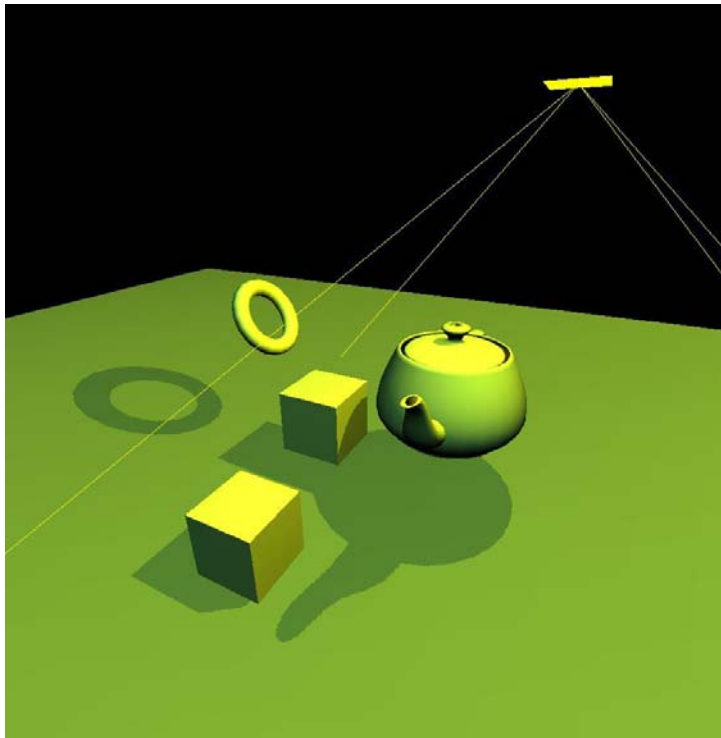

Figure 13. Shadow maps from *Luxo Jr.*

Hardware Shadow Maps

- Can be done with hardware texture mapping
 - Texture coordinates u, v, w generated using 4×4 matrix
 - Modern hardware permits tests on texture values



Hardware Shadow Maps Questions?

- Can be done with hardware texture mapping
 - Texture coordinates u, v, w generated using 4×4 matrix
 - Modern hardware permits tests on texture values

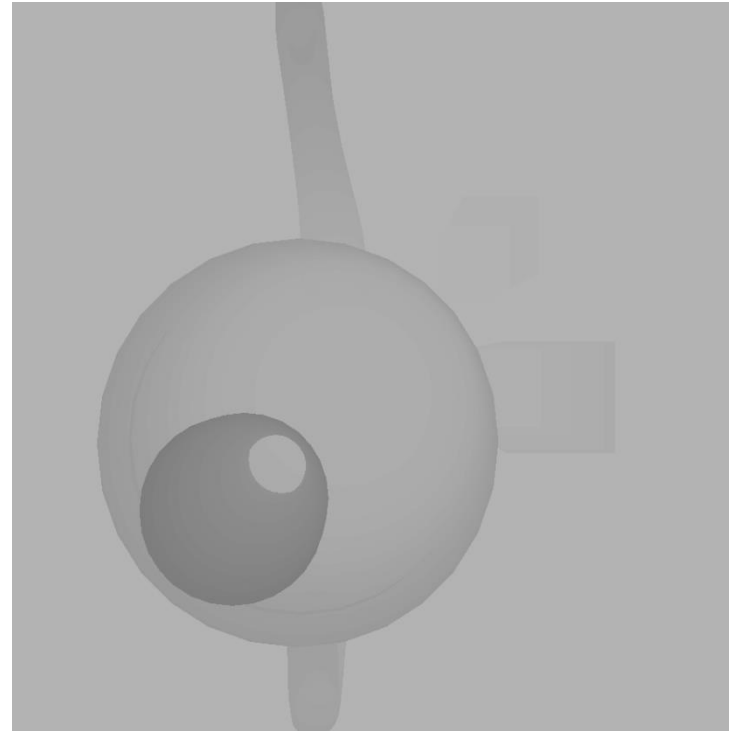
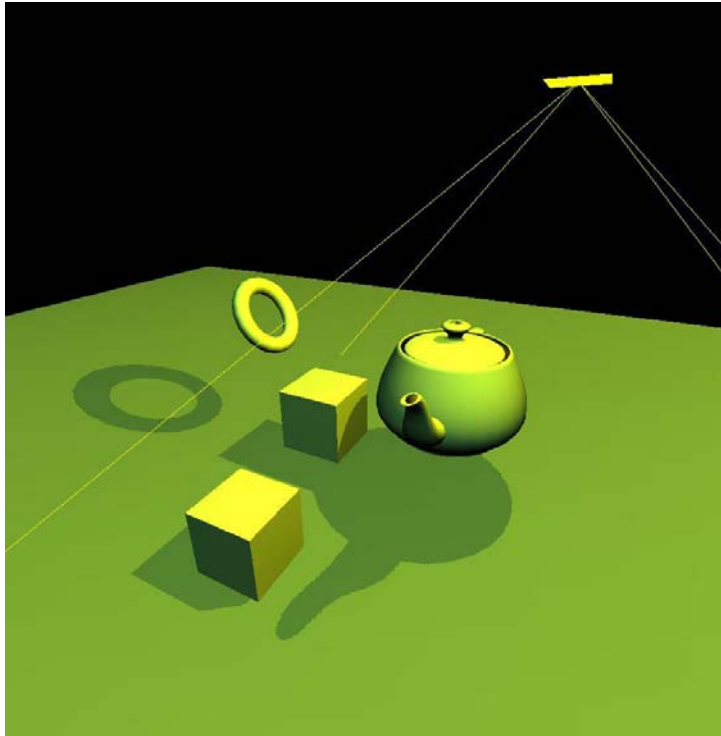

Today

- Shadow Maps
- **Shadow Volumes**
 - (The Stencil Buffer)
- Deep Shadow Maps
- Alias-free Shadow Maps

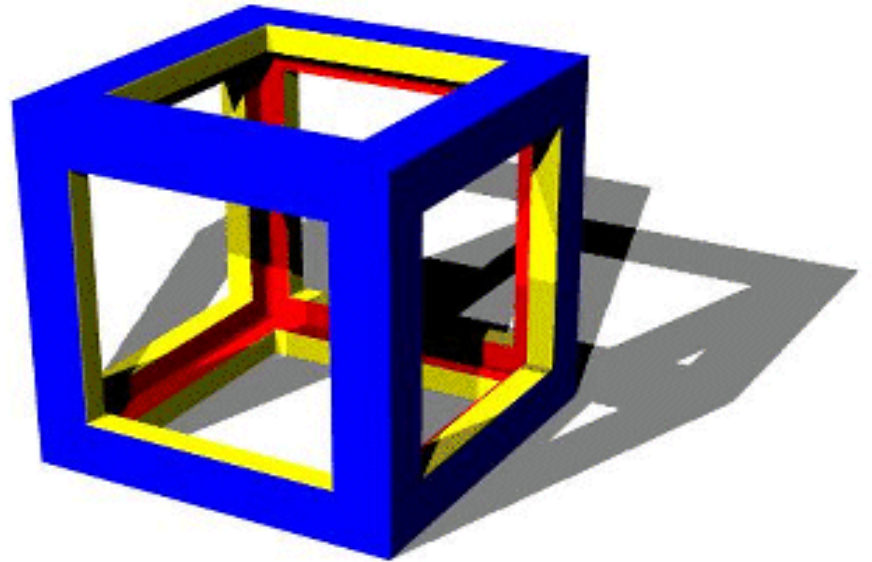

Shadow Volumes

- Explicitly represent the volume of space in shadow
- For each polygon
 - Pyramid with point light as apex
 - Include polygon to cap

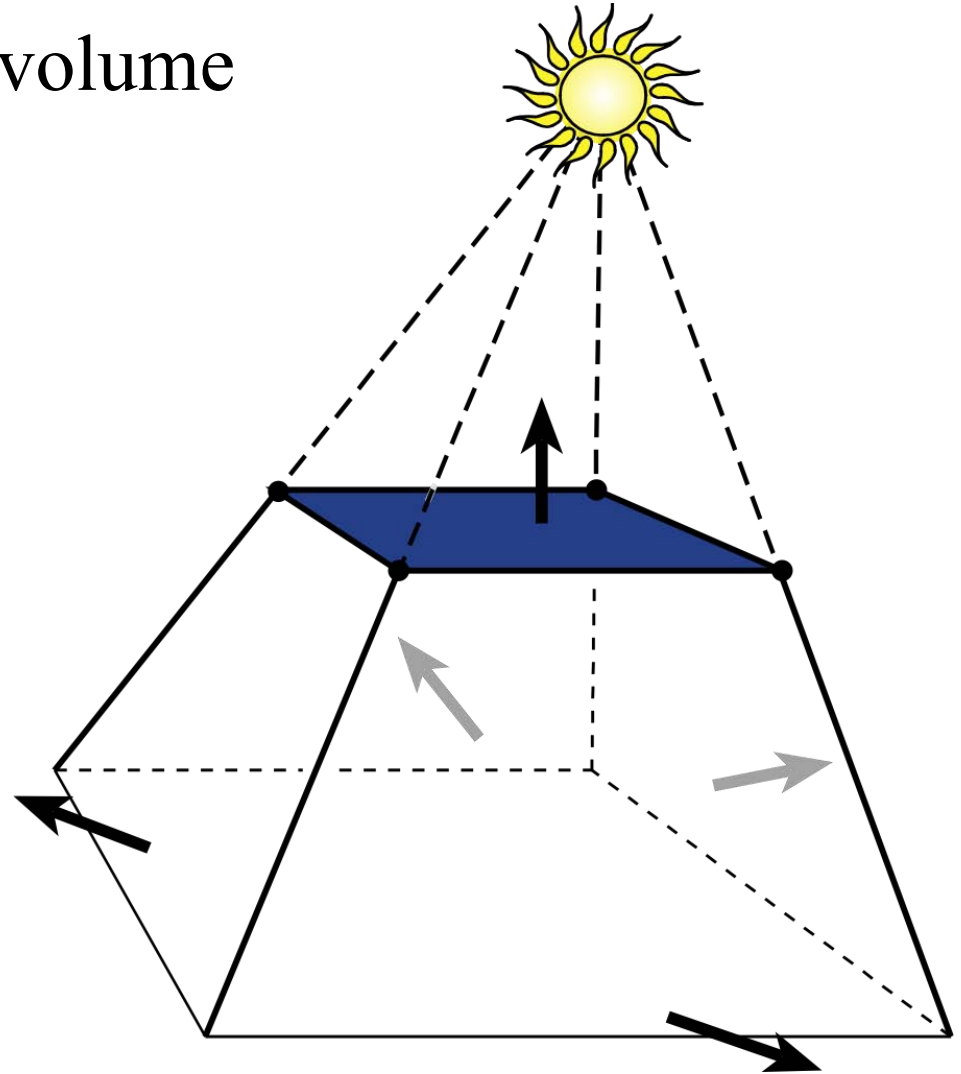

Shadow Volumes

- If a point is inside a shadow volume cast by a particular light, the point does not receive any illumination from that light
- Cost of naive implementation:
 $\#polygons * \#lights$

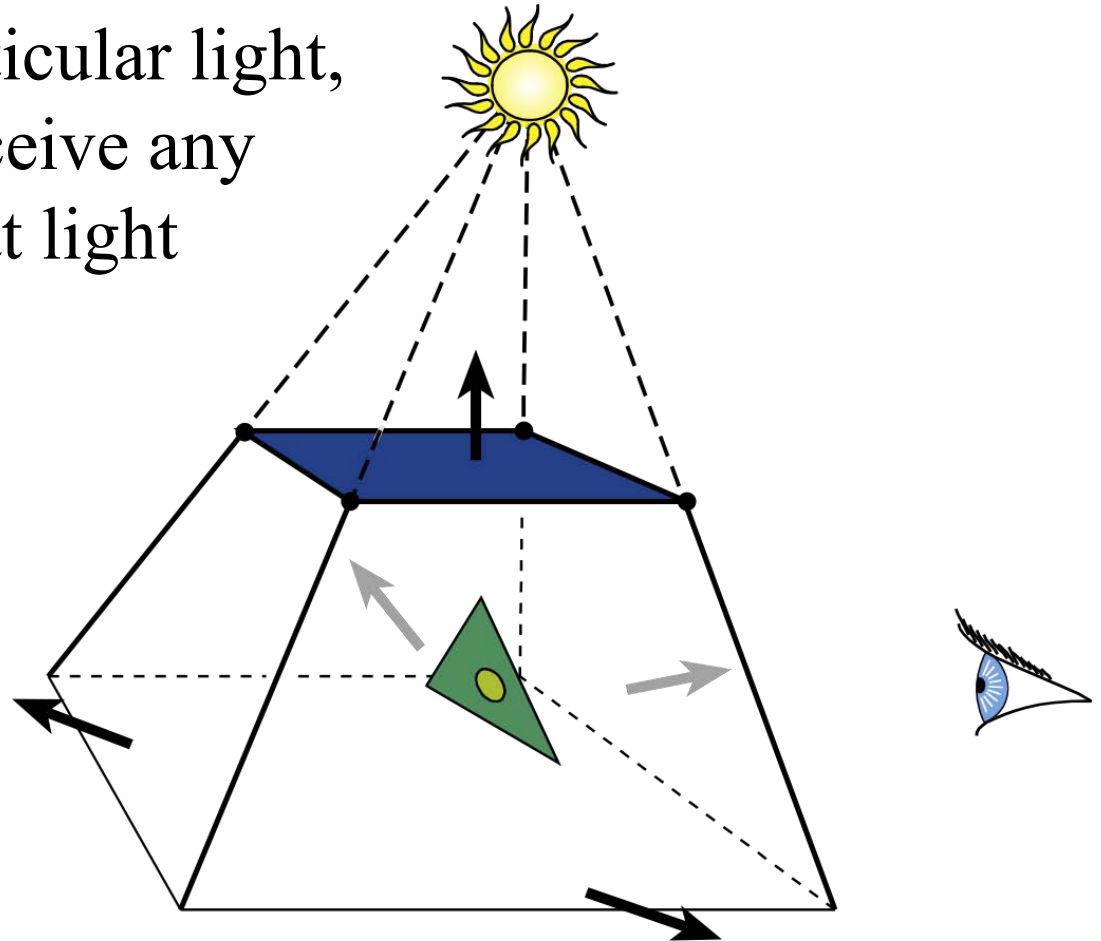

Shadow Volumes

Questions?

- If a point is inside a shadow volume cast by a particular light, the point does not receive any illumination from that light
- Cost of naive implementation:
 $\#polygons * \#lights$

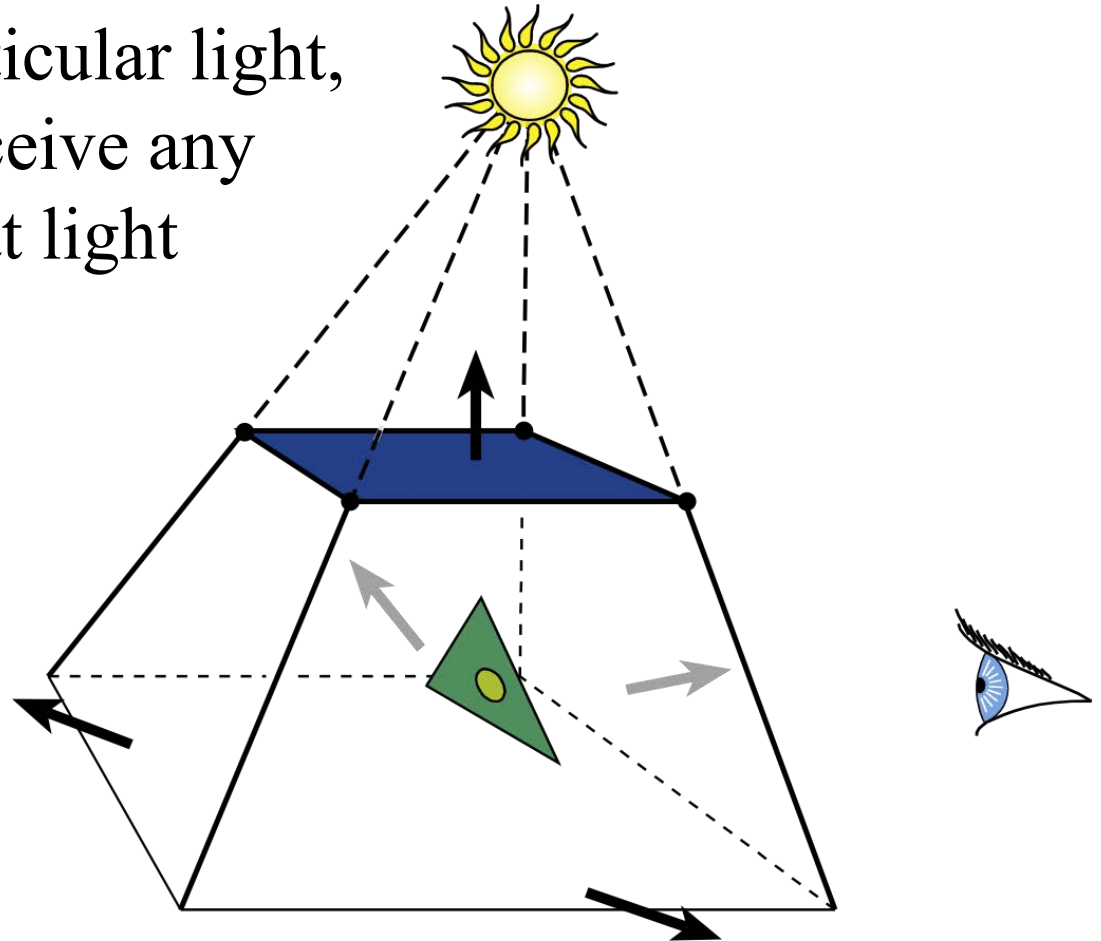

Better Shadow Volumes

- Shoot a ray from the eye to the visible point
- Increment/decrement a counter each time we intersect a shadow volume polygon
- If the counter $\neq 0$, the point is in shadow

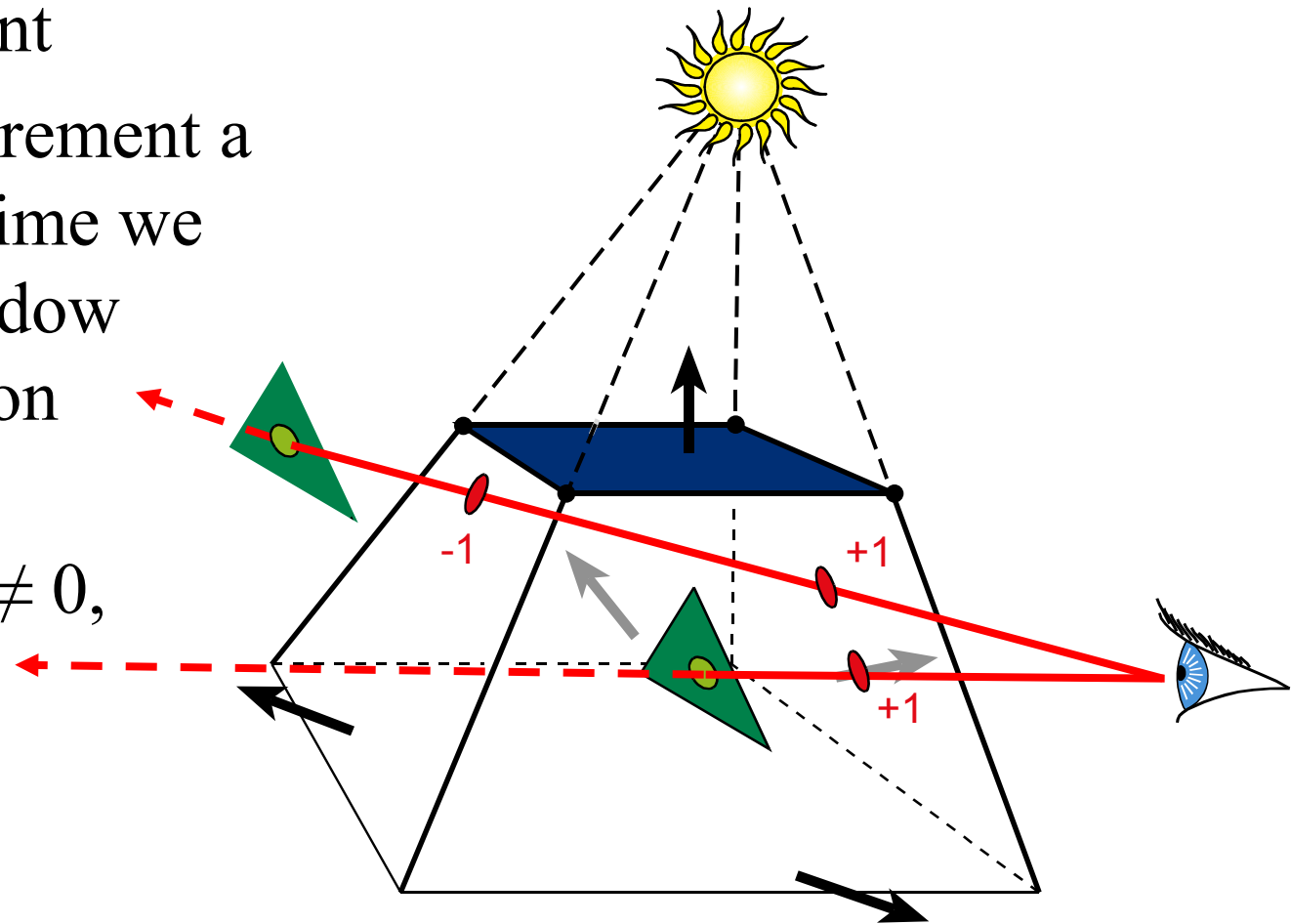

Stencil Buffer

- Tag pixels in one rendering pass to control their update in subsequent rendering passes
 - "For all pixels in the frame buffer" →
"For all *tagged* pixels in the frame buffer"
- Can specify different rendering operations for each case:
 - stencil test fails
 - stencil test passes & depth test fails
 - stencil test passes & depth test passes

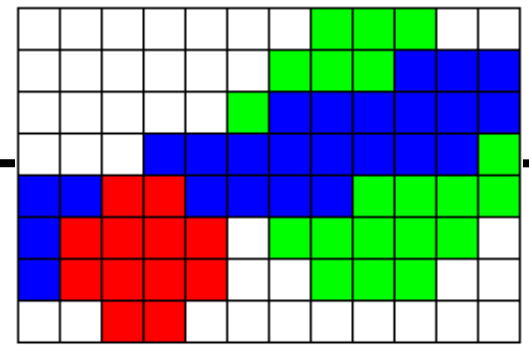

frame buffer

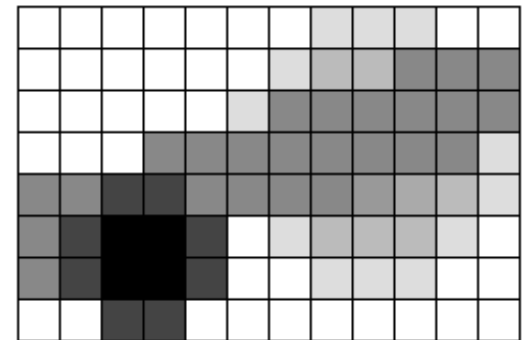

depth buffer

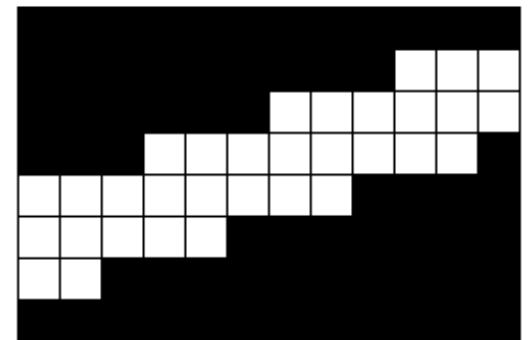

stencil buffer

Stencil Buffer – Real-time Mirror

- Clear frame, depth & stencil buffers
- Draw all non-mirror geometry to frame & depth buffers
- Draw mirror to stencil buffer, where depth buffer passes
- Set depth to infinity, where stencil buffer passes
- Draw reflected geometry to frame & depth buffer, where stencil buffer passes

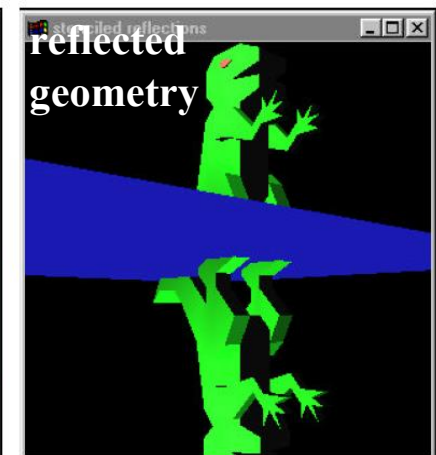
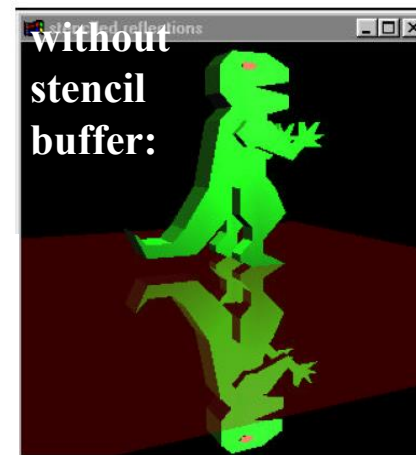
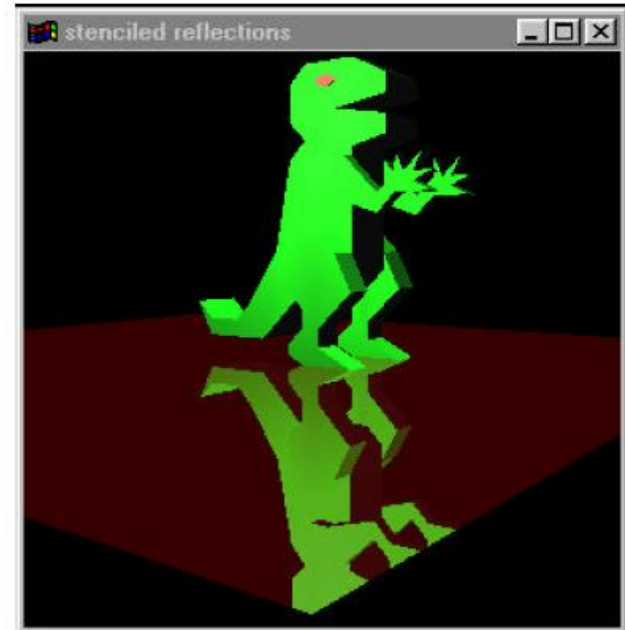

See **NVIDIA's stencil buffer tutorial**
<http://developer.nvidia.com>

also discusses blending, multiple mirrors, objects behind mirror, etc...

© NVIDIA. All rights reserved. This content is excluded from our Creative Commons license. For more information, see <http://ocw.mit.edu/help/faq-fair-use/>.

Shadow Volumes w/ the Stencil Buffer

Initialize stencil buffer to 0

Draw scene with ambient light only

Turn off frame buffer & z-buffer updates

Draw front-facing shadow polygons

If z-pass \rightarrow increment counter

Draw back-facing shadow polygons

If z-pass \rightarrow decrement counter

Turn on frame buffer updates

Turn on lighting and
redraw pixels with
counter = 0

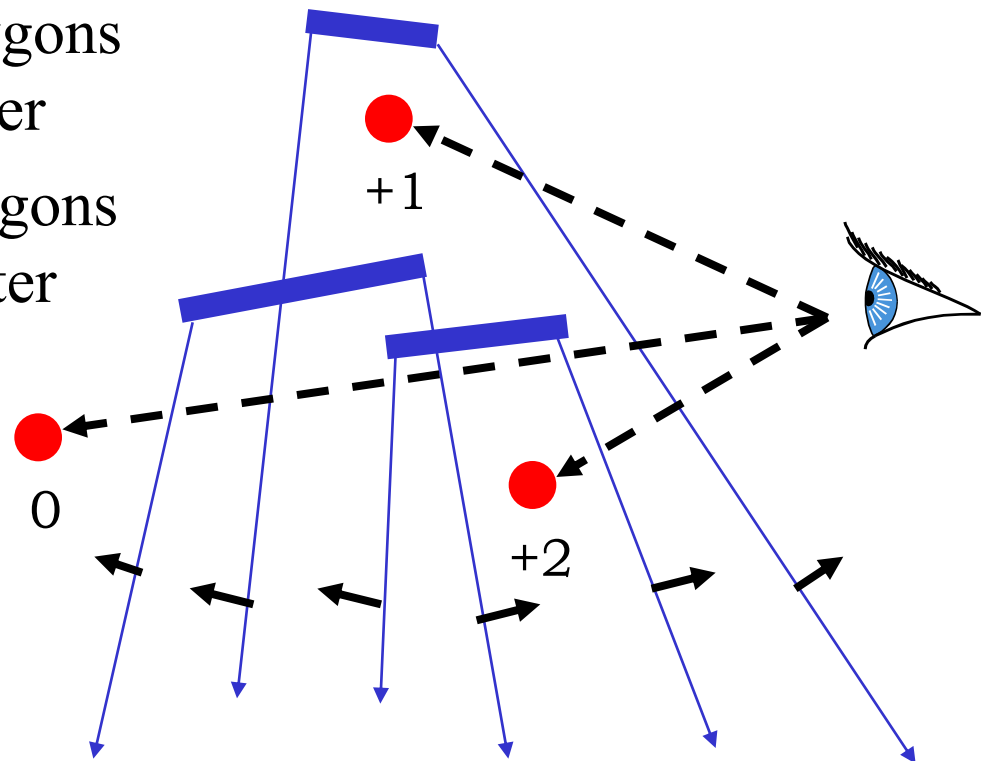
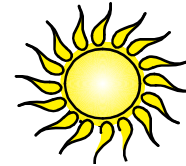

Shadow Volumes w/ the Stencil Buffer

Initialize stencil buffer to 0

Draw scene with ambient light only

Turn off frame buffer & z-buffer updates

Draw front-facing shadow polygons

If z-pass \rightarrow increment counter

Draw back-facing shadow polygons

If z-pass \rightarrow decrement counter

Turn on frame buffer updates

Turn on lighting and
redraw pixels with
counter = 0

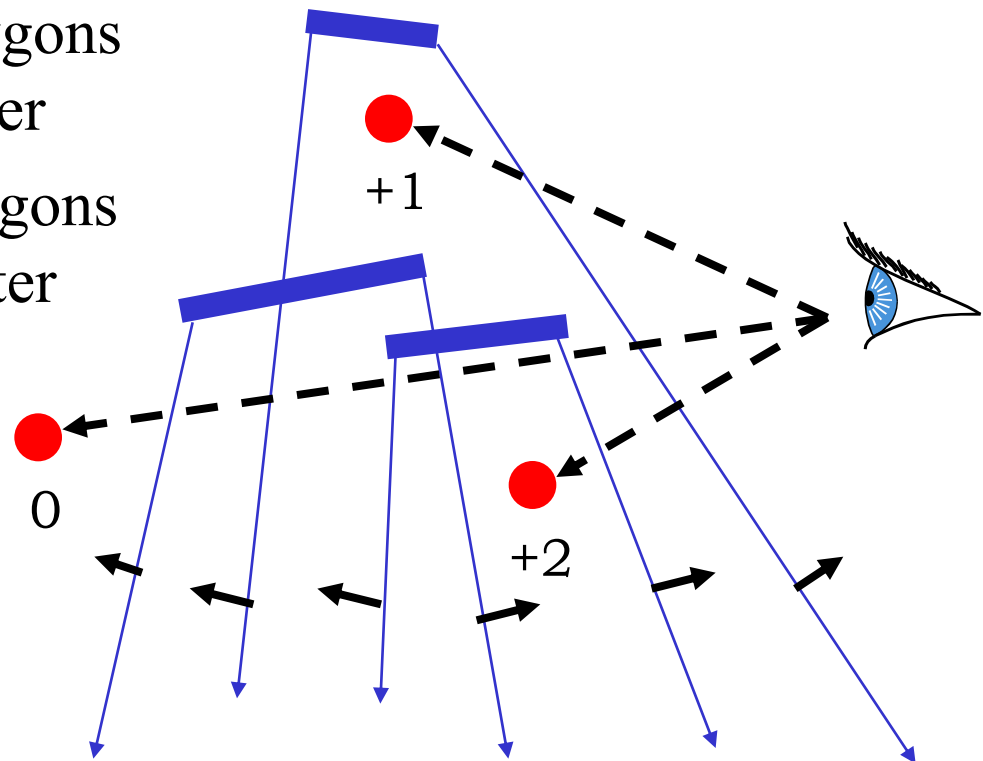
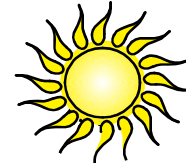

Questions?

If the Eye is in Shadow...

- ... then a counter of 0 does not necessarily mean lit

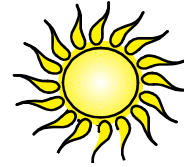

- 3 Possible Solutions:

1. Explicitly test eye point with respect to all shadow volumes
2. Clip the shadow volumes to the view frustum
3. "Z-Fail" shadow volumes

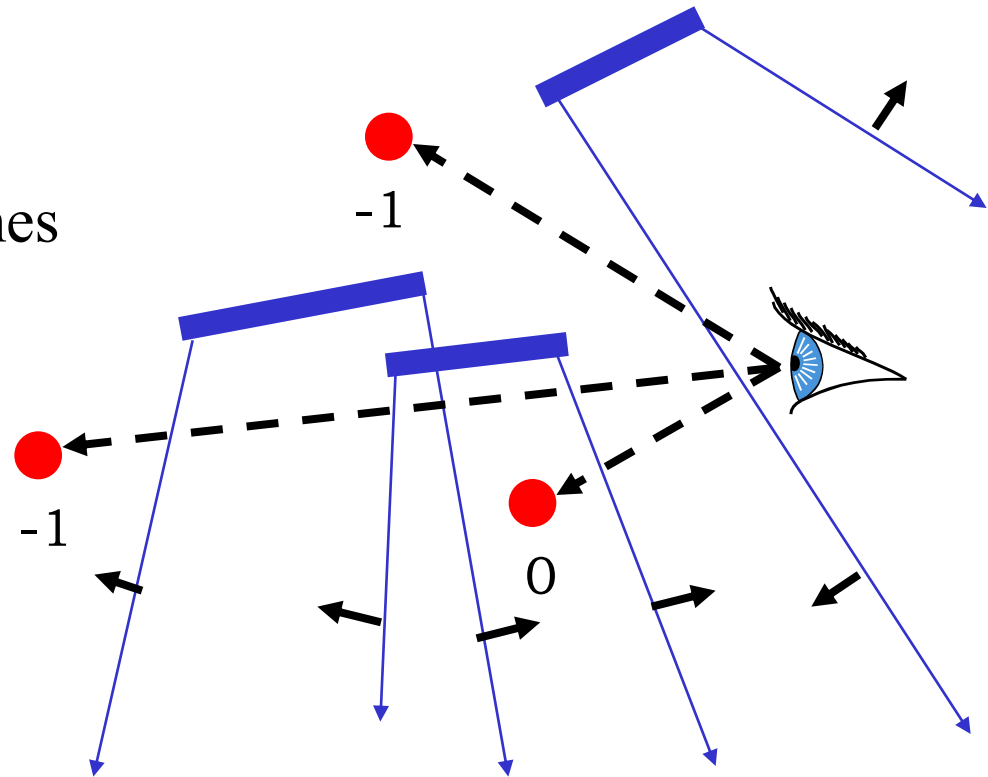

1. Test Eye with Respect to Volumes

- Adjust initial counter value

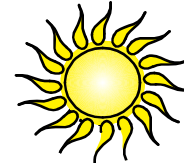

Expensive

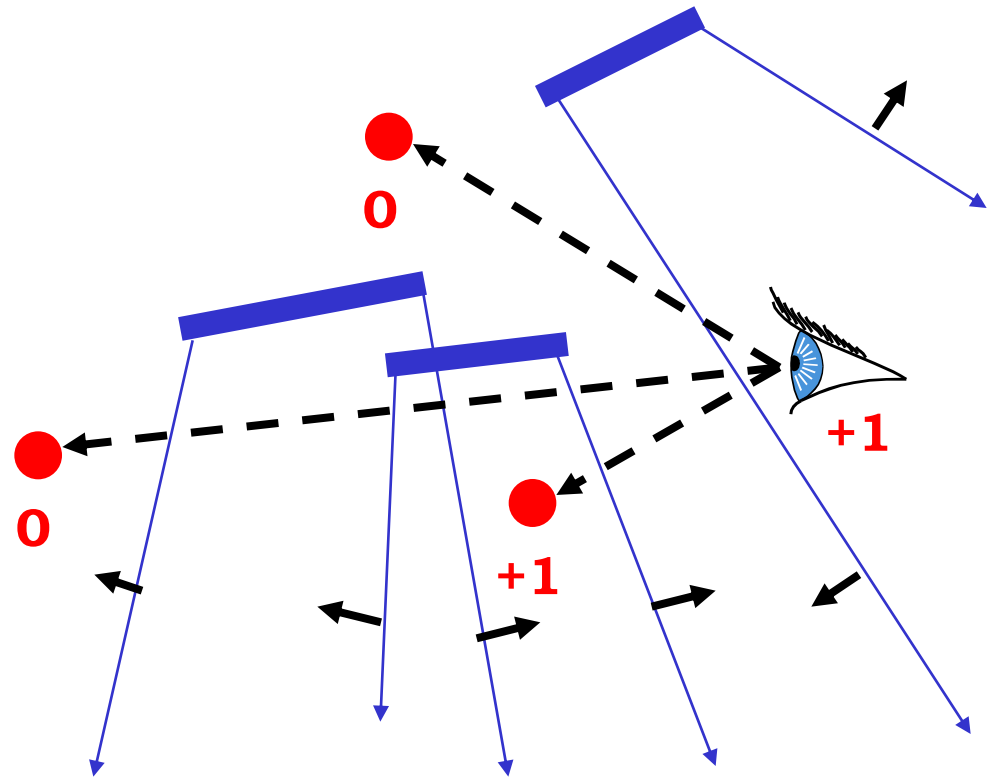

2. Clip the Shadow Volumes

- Clip the shadow volumes to the view frustum and include these new polygons
- *Messy CSG*

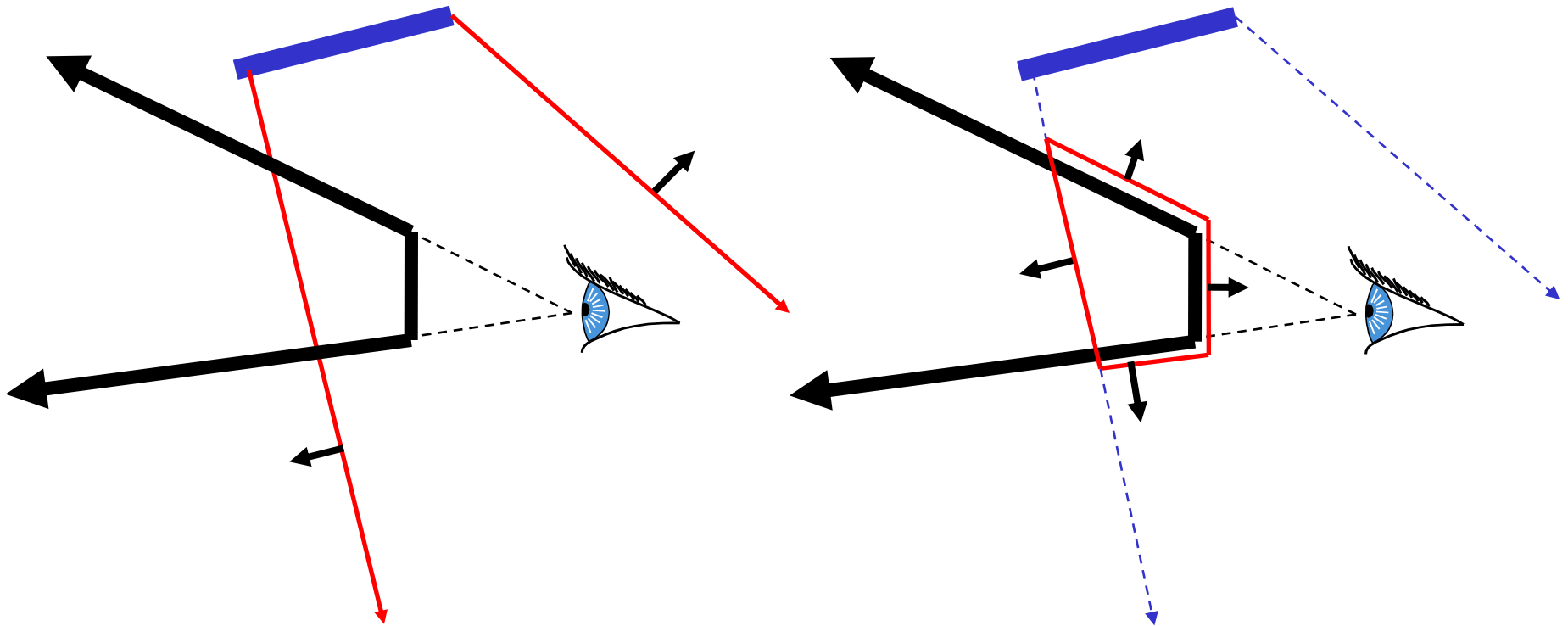

3. "Z-Fail" Shadow Volumes

Start at infinity

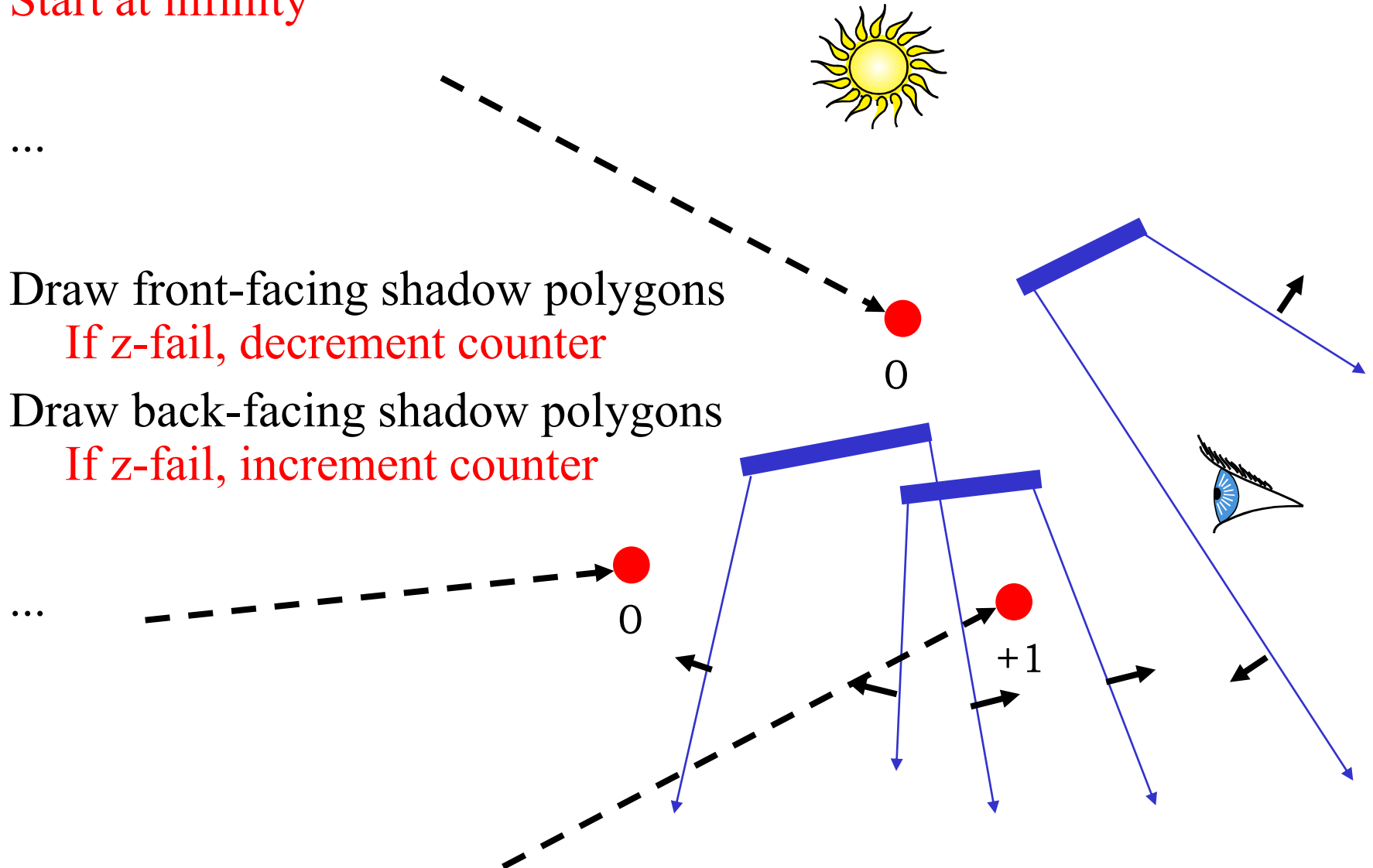

3. "Z-Fail" Shadow Volumes

- Introduces problems with far clipping plane
- Solved by clamping the depth during clipping

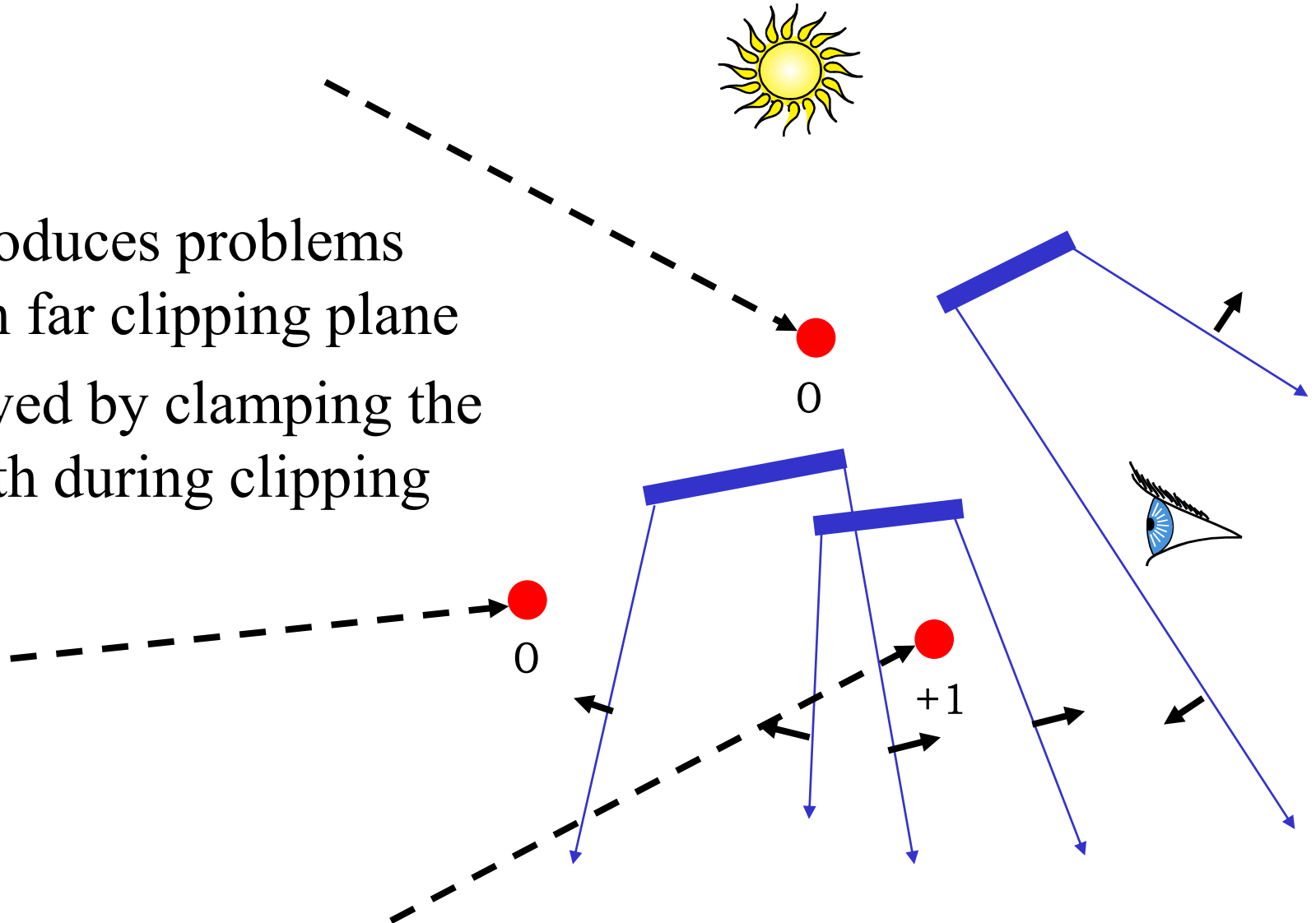

3. "Z-Fail" Shadow Volumes

- Introduces problems with far clipping plane
- Solved by clamping the depth during clipping

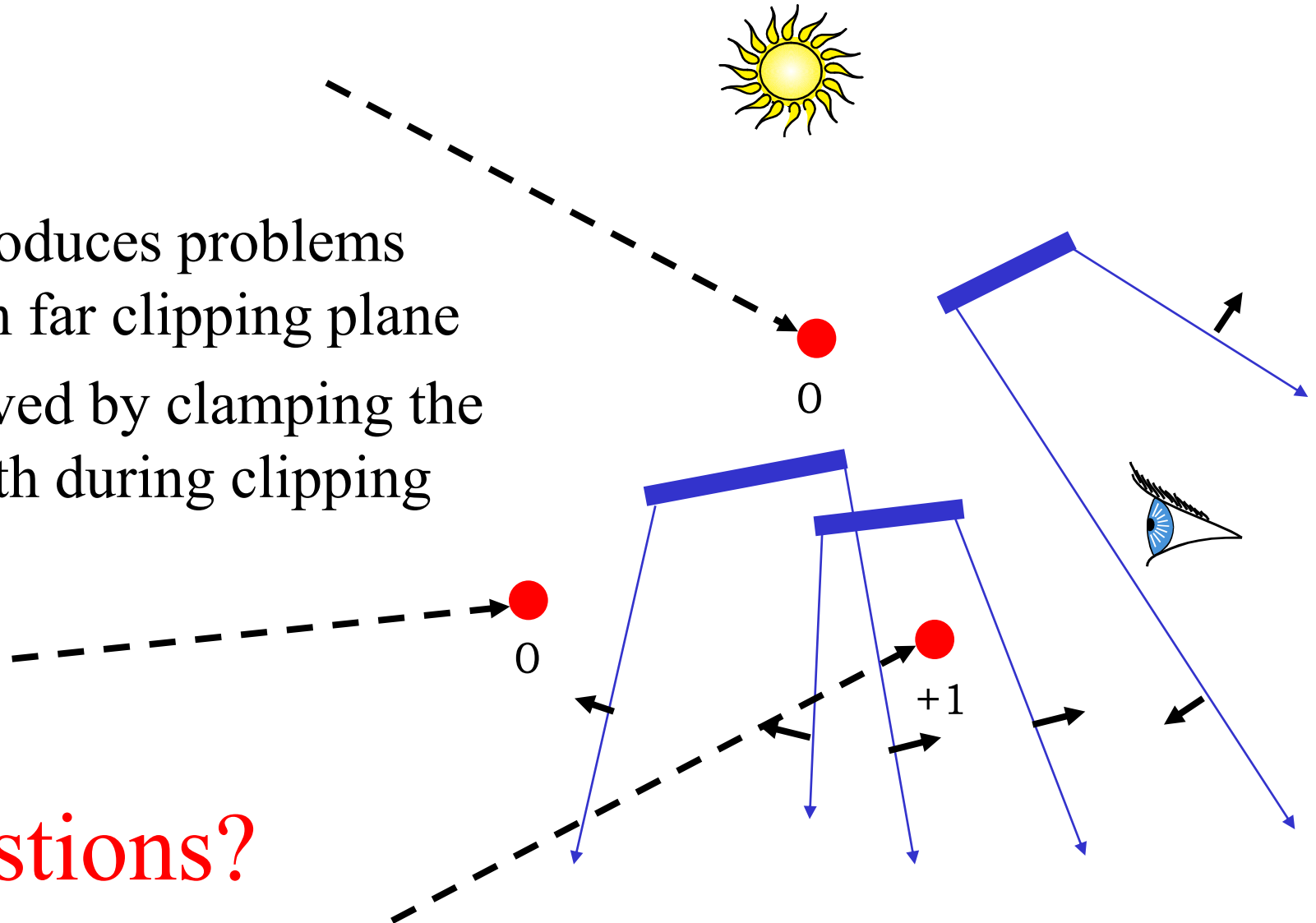

Questions?

Optimizing Shadow Volumes

- Use silhouette edges only (edge where a back-facing & front-facing polygon meet)

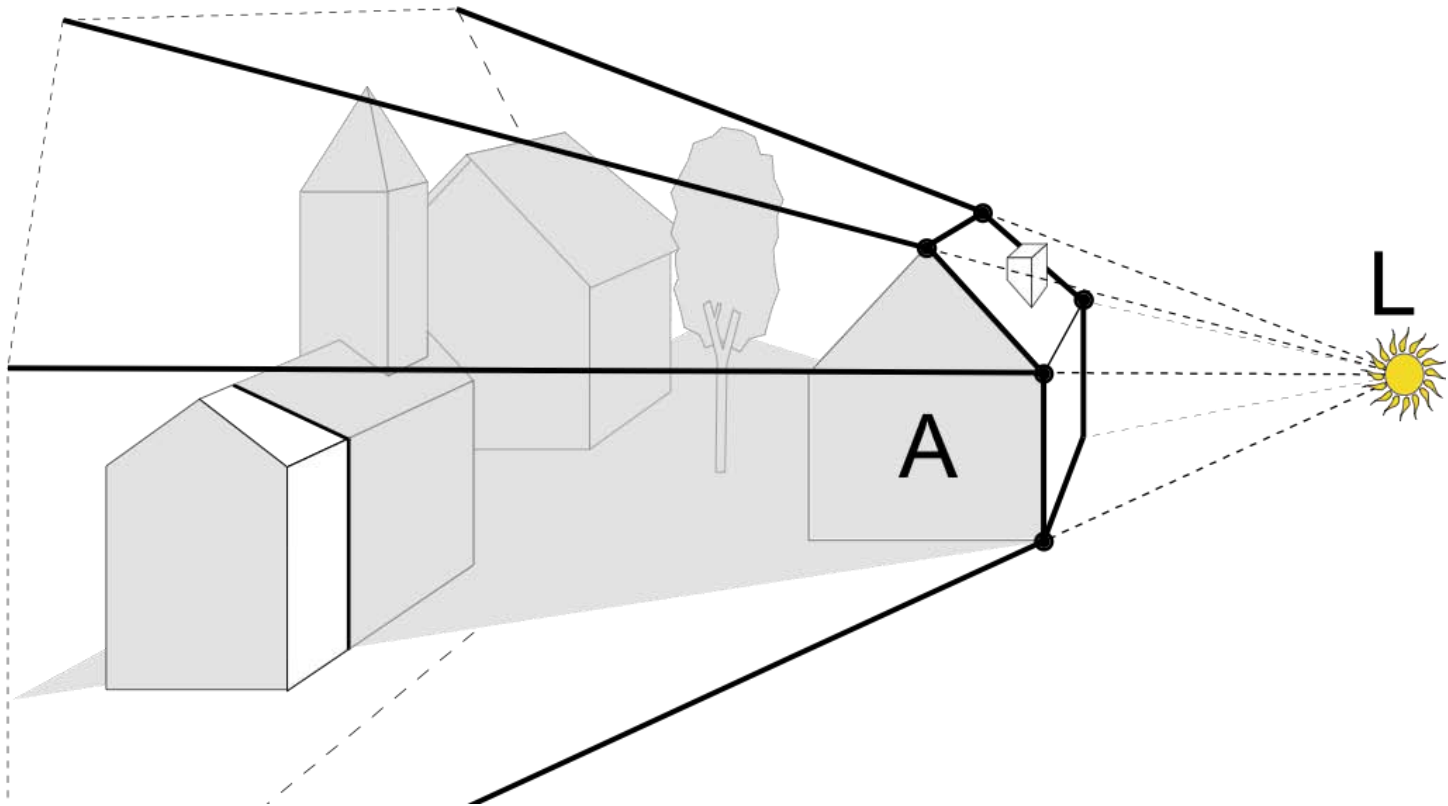

Shadow Volumes Are Sort of Passé

- It is possible to implement shadow volumes rather efficiently using the stencil buffer
 - John Carmack’s Doom 3 engine did this very well
 - Shadow volumes had their 15 minutes of popularity around that time
 - NVIDIA even came up with hardware acceleration (“UltraShadow”)

Id Software

- Further info

Screenshot from video game Doom 4 removed due to copyright restrictions.

- [Wikipedia](#)
- [Aila & Akenine-Möller: Hierarchical Shadow Volumes, Proc. Graphics Hardware 2004](#)

Shadow Volumes Are Sort of Passé

- The need to extract silhouette edges and rasterize the resulting shadow polygons is just too much work when scene complexities and image resolutions grow
- Still, such use of the stencil buffer can be useful for other tricks



???

© source unknown. All rights reserved. This content is excluded from our Creative Commons license. For more information, see <http://ocw.mit.edu/help/faq-fair-use/>.

Shadow Volumes Are Sort of Passé

- The need to extract silhouette edges and rasterize the resulting shadow polygons is just too much work when scene complexities and image resolutions grow
- Shadow maps are bad, but they're the best we've got!

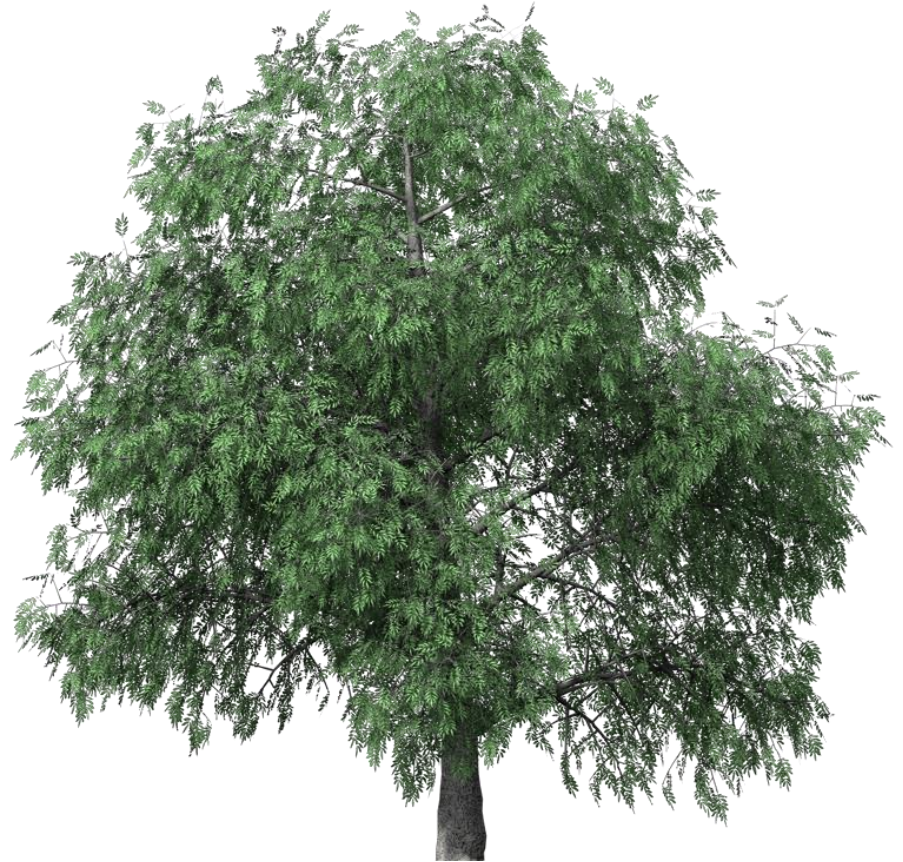

???

© source unknown. All rights reserved. This content is excluded from our Creative Commons license. For more information, see <http://ocw.mit.edu/help/faq-fair-use/>.

Further Reading on Shadows

- Some recent techniques allow filtering the shadow map instead of just the tests (percentage closer)
 - Works pretty well in some situations, although not general
 - [Variance Shadow Maps \(Donnelly, Lauritzen I3D 2006\)](#)
 - Convolution Shadow Maps
 - [Annen et al., SIGGRAPH 2008](#)
 - [Annen et al., EGSR 2007](#)
- An interesting hybrid between shadow maps and ray tracing
 - [Aila and Laine, Alias-Free Shadow Maps, EGSR 2004](#)

Annen et al. 2008



© ACM. All rights reserved. This content is excluded from our Creative Commons license. For more information, see <http://ocw.mit.edu/help/faq-fair-use/>.

Today

- Shadow Maps
- Shadow Volumes
 - (The Stencil Buffer)
- **Deep Shadow Maps**
- Alias-free Shadow Maps

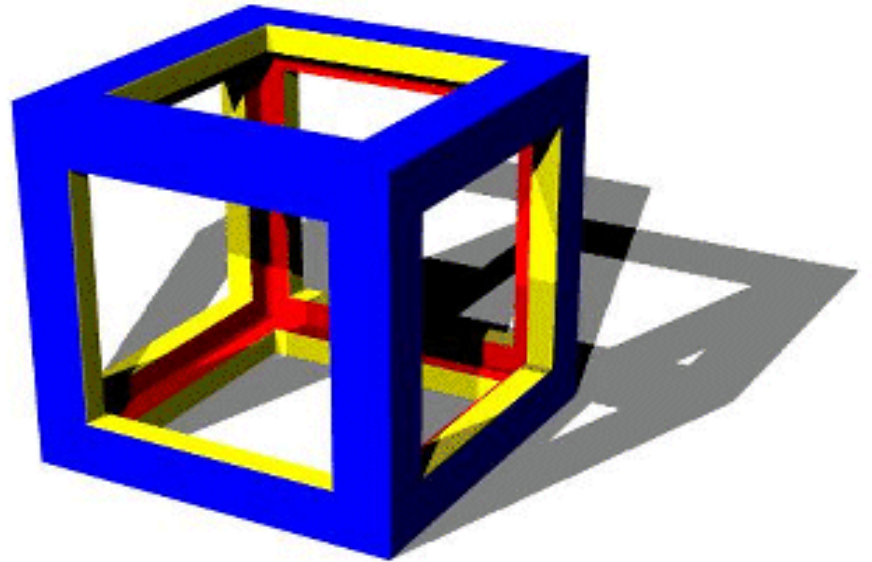

Deep shadow maps

- Lokovic & Veach, Pixar
- Shadows in participating media like smoke, inside hair, etc.
 - They represent not just depth of the first occluding surface, but the attenuation along the light rays
- Note: shadowing only, no scattering



Visibility function along depth

- Fraction of a pixel occluded, as a function of depth
- Due to
 - small occluders, semi-transparent objects, smoke & volumetric effects

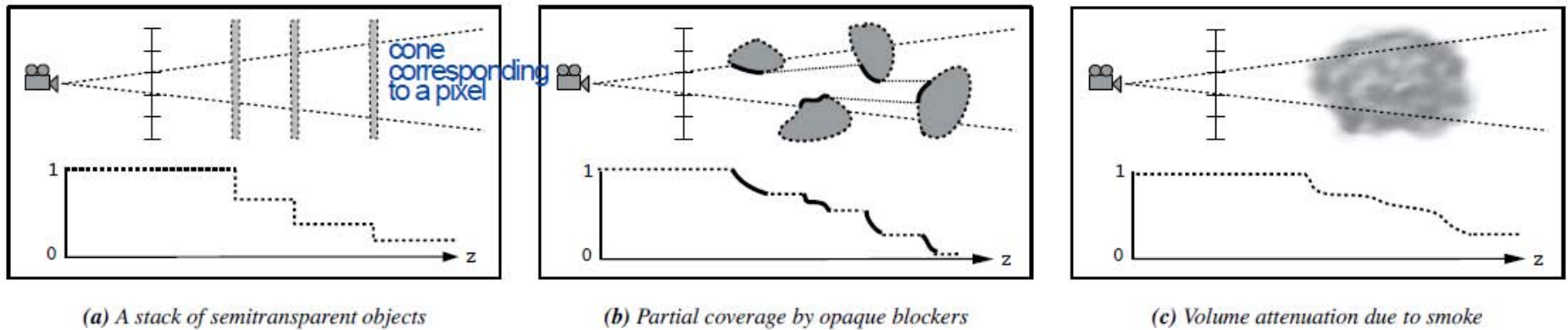

Figure 3: Visibility functions in flatland. Each diagram shows a beam of light that starts at the shadow camera origin (i.e. the light source) and passes through a single pixel of the deep shadow map, accompanied by that pixel's visibility function. (a) The beam's power is reduced as it passes through consecutive semitransparent surfaces. (b) The blockers are opaque, but each covers only part of the pixel's area; the emphasized segments of the function correspond to visible portions of the blockers. (c) Passage through smoke reduces the beam's power in a more continuous manner.

Deep shadow maps

- Preprocess:
Compute dense visibility function for each pixel of shadow map
 - send lots of rays or rasterize at a high resolution
 - compress visibility function at each pixel
 - to reduce memory cost
- At render time, shadow query
 - Transform visible point into light coordinates
 - just like shadow maps
 - Read visibility value from compressed function

Compression algorithm

- Approximation:
Piecewise linear
- Set an error bound
- Decide which vertices to keep
- Greedy from zero do far

Figure 5: Our compression algorithm. (a) A piecewise linear curve and an illustration of its error bound. (b) Each input vertex defines a target window that constrains the slope of the next output segment. (c) The current slope range is intersected with each target window until it would become empty. (d) The output segment is extended to the current z value with a slope equal to the midpoint of the current slope range, and this process is repeated.

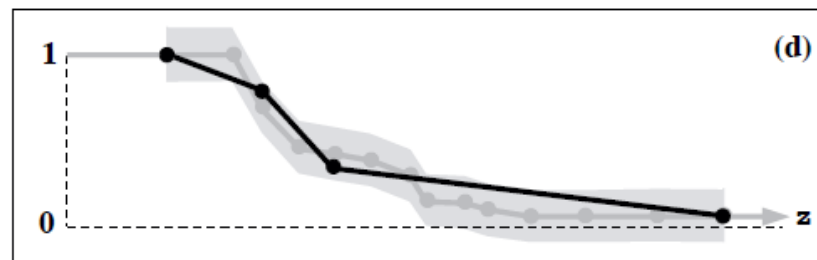
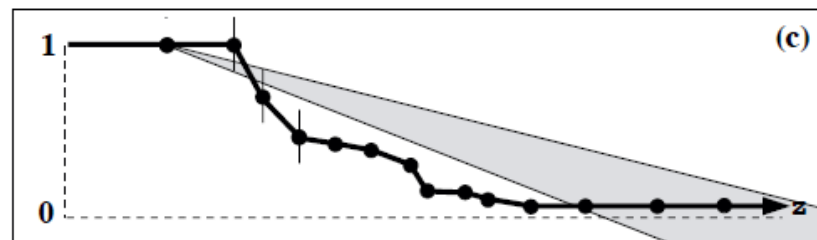
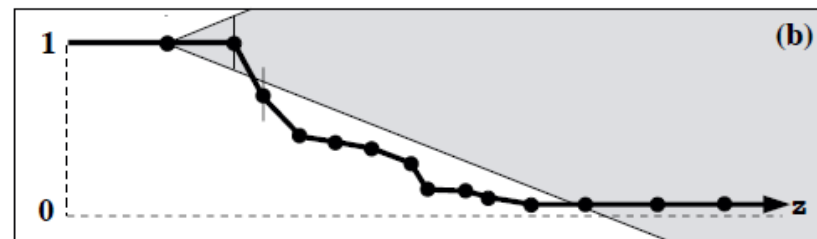
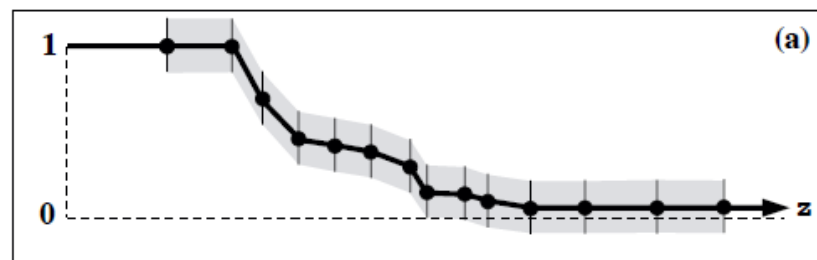

Deep shadow map results



Figure 11: A cloud with pipes. Notice the shadows cast from surfaces onto volumetric objects and vice versa. A single deep shadow map contains the shadow information for the cloud as well as the pipes.

Deep shadow map results

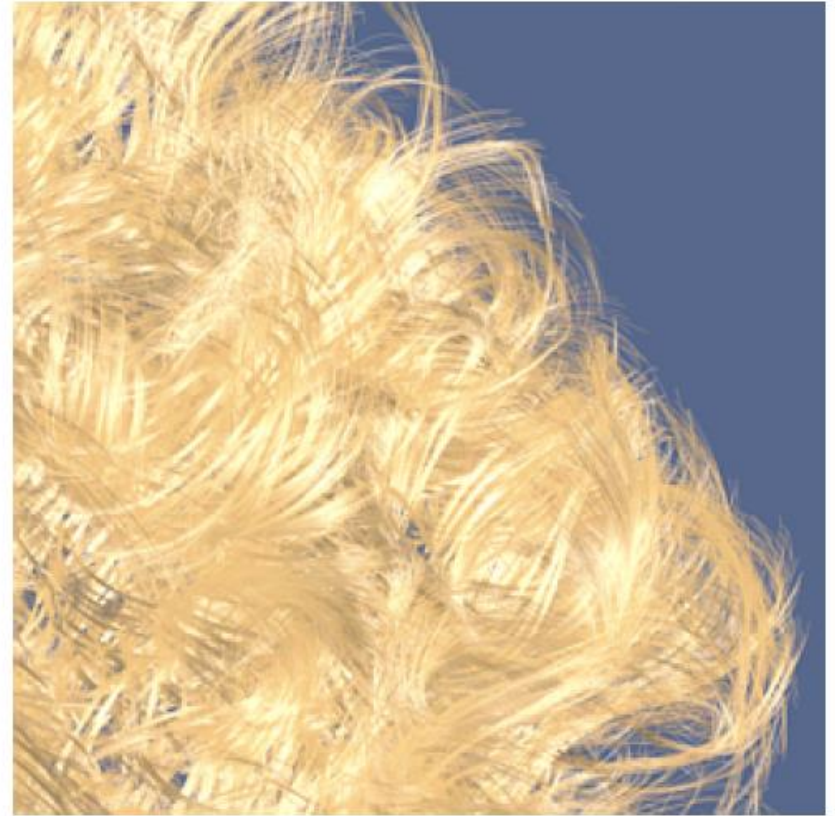

Figure 1: Hair rendered with and without self-shadowing.

© ACM. All rights reserved. This content is excluded from our Creative Commons license. For more information, see <http://ocw.mit.edu/help/faq-fair-use/>.

Deep shadow map results

- Advantage of deep shadow map over higher-resolution normal shadow map:
Pre-filtering for shadow antialiasing



(a) Ball with 50,000 hairs



(b) 512×512 Normal shadow map



(c) $4k \times 4k$ Normal shadow map



(d) 512×512 Deep shadow map

© ACM. All rights reserved. This content is excluded from our Creative Commons license. For more information, see <http://ocw.mit.edu/help/faq-fair-use/>.

Enables motion blur in shadows

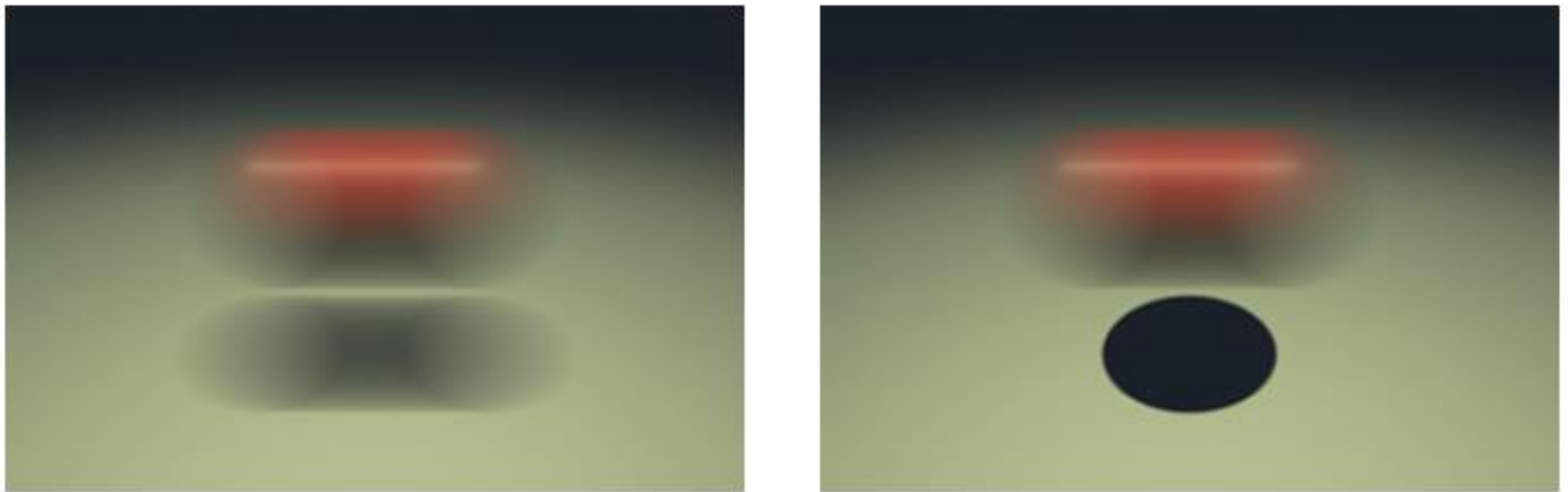

Figure 12: Rapidly moving sphere with and without motion blur.

© ACM. All rights reserved. This content is excluded from our Creative Commons license. For more information, see <http://ocw.mit.edu/help/faq-fair-use/>.

Enables motion blur in shadows

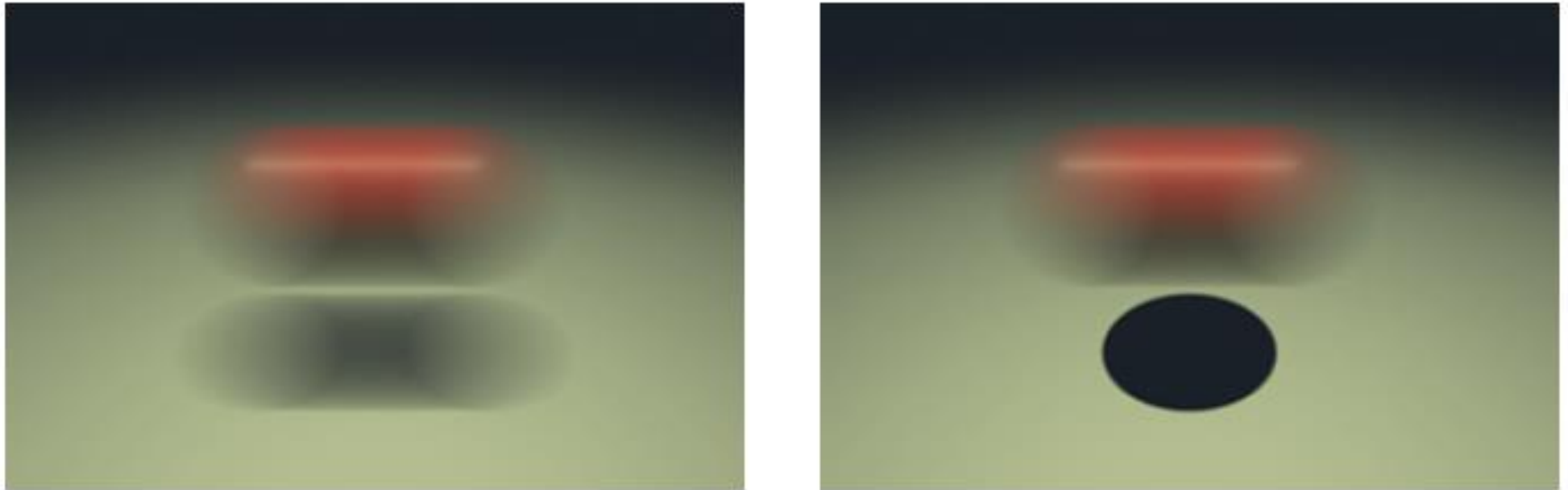

Figure 12: Rapidly moving sphere with and without motion blur.

© ACM. All rights reserved. This content is excluded from our Creative Commons license. For more information, see <http://ocw.mit.edu/help/faq-fair-use/>.

Questions?

Today

- Shadow Maps
- Shadow Volumes
 - (The Stencil Buffer)
- Deep Shadow Maps
- **Alias-free Shadow Maps**

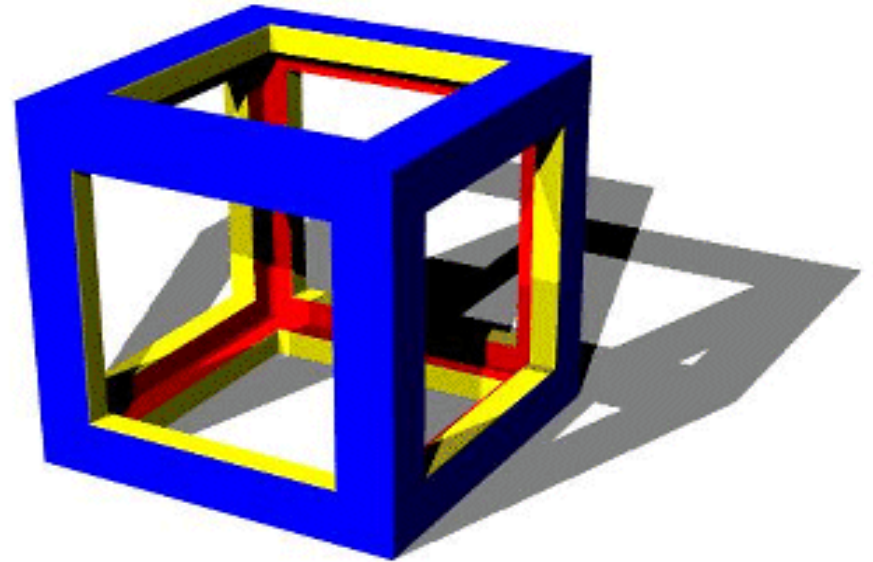

Alias-free shadow maps

- Aila and Laine,
<http://www.tml.tkk.fi/~timo/>
- aka Irregular z-buffer by Johnson et al.
<http://pl887.pairlitesite.com/papers/tog05-izb/>
- Following slides by Aila and Laine

Content removed due to copyright restrictions -- please see slide 4,6-14 from Timo Aila and Samuli Laine's talk slides on "Alias-Free Shadow Maps." available at <https://research.nvidia.com/publication/alias-free-shadow-maps> for further details.

Irregular z buffer results

A video clip demonstrating the irregular z buffer results has been removed due to copyright restrictions.

That's All For Today!

Image removed due to copyright restrictions -- please see Fig. 4 in S. Laine and T. Aila, "Hierarchical Penumbra Casting." Computer Graphics Forum 24(3) (Eurographics 2005) for further details.

MIT OpenCourseWare
<http://ocw.mit.edu>

6.837 Computer Graphics
Fall 2012

For information about citing these materials or our Terms of Use, visit: <http://ocw.mit.edu/terms>.