



Differential Diagnosis

“**Diagnosis** is the identification of the nature and cause of a certain phenomenon”

“**differential diagnosis** is the distinguishing of a particular **disease** or condition from others that present similar clinical features”

—Wikipedia



**Massachusetts
Institute of
Technology**

Models for Diagnostic Reasoning

- Flowcharts
- Based on associations between diseases and {signs, symptoms}
 - “*manifestations*” covers all observables, including lab tests, bedside measurements, ...
- Single disease vs. multiple diseases
- Probabilistic vs. categorical
- Utility theoretic
- Rule-based
- Pattern matching

Sign: Any objective evidence of disease, as opposed to a **symptom**, which is, by nature, subjective. For example, gross blood in the stool is a sign of disease; it is evidence that can be recognized by the patient, physician, nurse, or someone else. [Abdominal pain](#) is a symptom; it is something only the patient can perceive.

<https://www.medicinenet.com/script/main/art.asp?articlekey=5493>

Flowchart

- BI/Lincoln Labs Clinical Protocols

U.T.I./ VAGINITIS PROTOCOL (12/73)

Unit#: _____ Date: _____

Name: _____

Birthdate: _____ Phone: _____

Provider: _____

yes no SUBJECTIVE

Vaginal discharge, unusual
Days duration _____

Vaginal/vulvar itch/irritation
Days duration _____

Pain/burning on urination
Inside urethra _____

Outside on a raw area
Days duration _____

Unusually frequent urination
Days duration _____

Rx for any of above in past 3 mo

Age ≥ 45

Pregnant now

Diabetic

New pain side/back/belly/pelvis

Severe

Any blue boxes checked

Gyn procedure in past 2 mo

Meds inserted into vagina
in past few days

Any grey boxes checked

Incontinence (prior to UTI Sx)

Vomiting/too nauseated to eat

Fever by Hx in past 48 hrs

Chills, teeth chatter

Hx of hospitalization for UT prob.

Kidney X-ray (IVP)

Bladder/kidney stones

Cystoscopy/in-dwelling catheter

High blood pressure

Had a UTI before age 12

Past UTI's ≥ 3

Antibiotic taken in past 3 weeks

OBJECTIVE

Temperature ≥ 100 _____

Systolic BP ≥ 160 or Diastolic ≥ 95
BP: _____

A Any grey boxes checked

CVA tenderness

Do urinalysis and culture

Bact _____ WBC _____ RBC _____

≥ 3+ protein _____

Any sugar _____

Bact ≥ 2+ or WBC ≥ 20? **Dx UTI**

≥ 10 RBC _____

A ≥ 2+ protein _____

Stop Any blue boxes checked

Stop Any red boxes checked? **Consult MD**

Do Pelvic (Pap & GC culture)

Abnormalities-not discharge

Cervix painful on movement

Urethral/cervical discharge?
Do GC gram stain

Abnormal vaginal discharge

Looks like cottage cheese? **Dx monilia**

Monilia prep positive? **Dx monilia**

Trich prep positive? **Dx trichomonas**

Any vag dx? **Dx non-specific vaginitis**

Any dx yet?

Any greys? **Dx urethritis**

Stop Any reds? **Consult MD**

Stop Will consult MD for other reasons

PLAN (also see back of protocol)

Dx of trichomonas? **Rx Flagyl**

Dx of monilia? **Rx Mycostatin**

Dx of non-specific vaginitis?

Stop Sulfa allergy? **Consult MD** **Rx Sultrin**

Stop Dx of UTI/urethritis

Dx of urethritis/vaginitis

Dysuria so bad pt can hardly urinate

Frequency interfering with work
or sleep? **Rx as below but tell pt
to wait for culture result before
beginning med**

Sulfa allergy? **Rx Sulfisoxazole**

Tetracycline allergy? **Rx Tetracycline**

Penicillin/Ampicillin allergy?
Consult MD **Rx Ampicillin**

Copyright: The Beth Israel Hospital Association, Boston, and Massachusetts Institute of Technology, Cambridge, 1974 -- HEW Contract No. HSM 110-73-335.

Disease = {signs & symptoms}

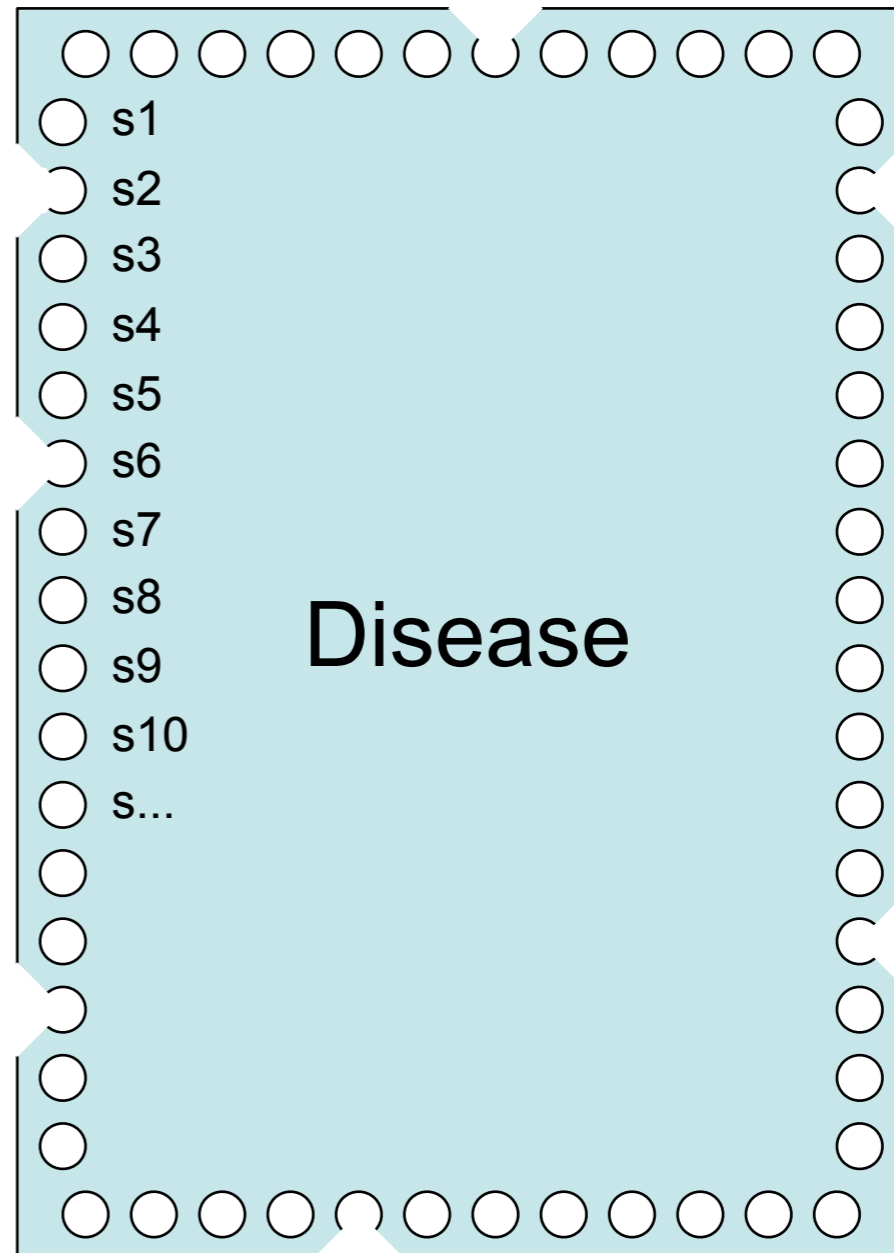
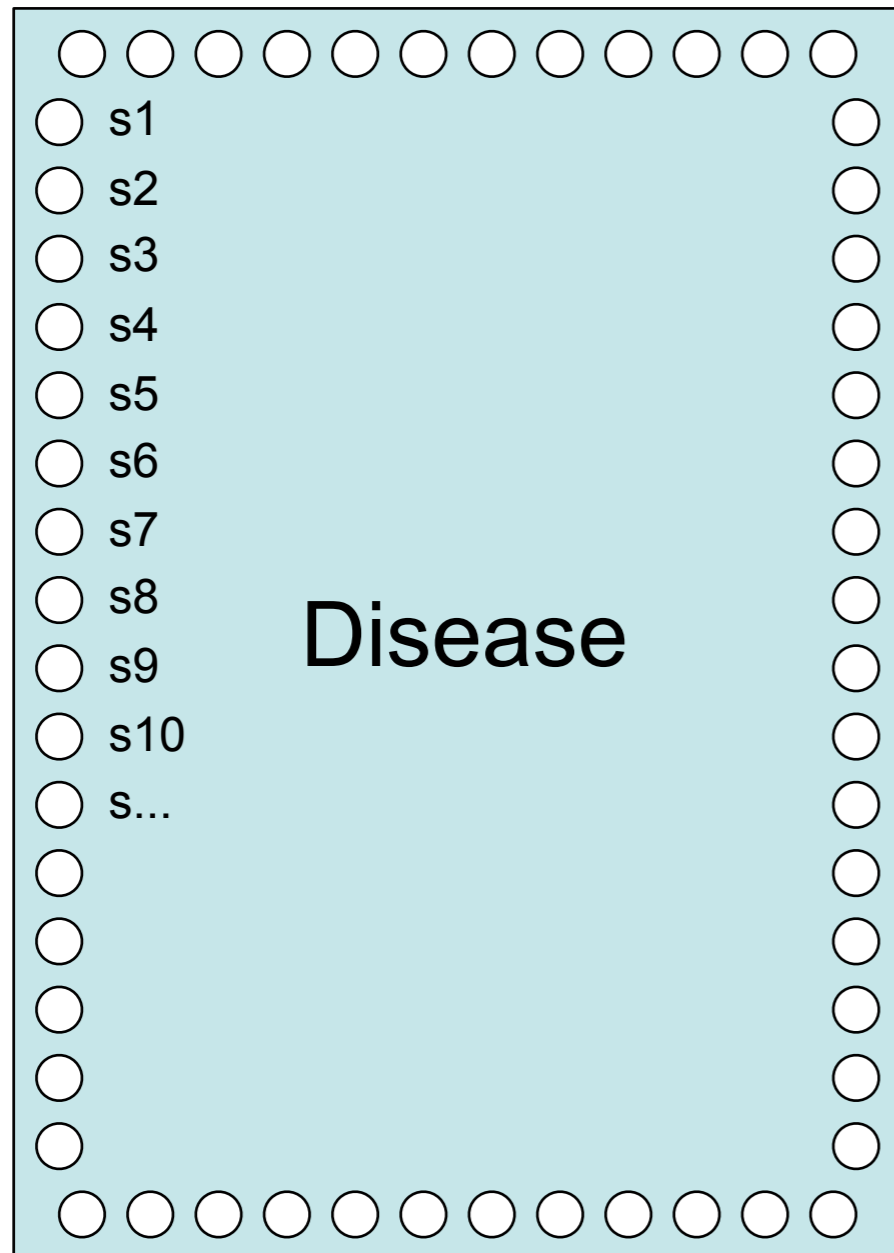

Diagnosis by Card Selection

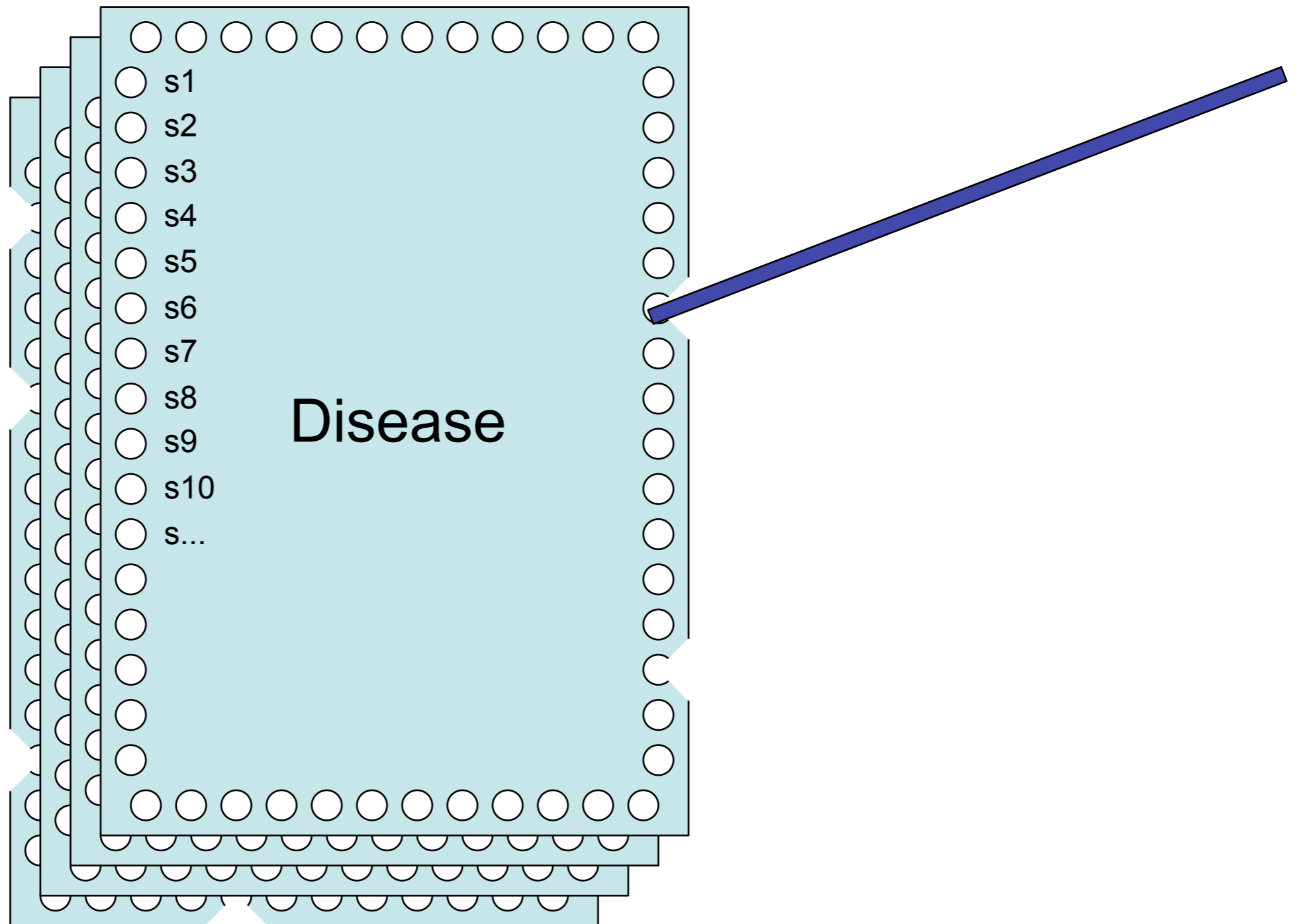

Naïve Bayes

- **Exhaustive** and **Mutually Exclusive** disease hypotheses (1 and only 1)
- **Conditionally independent** observables (manifestations)
- $P(D_i)$, $P(M_{ij}|D_i)$

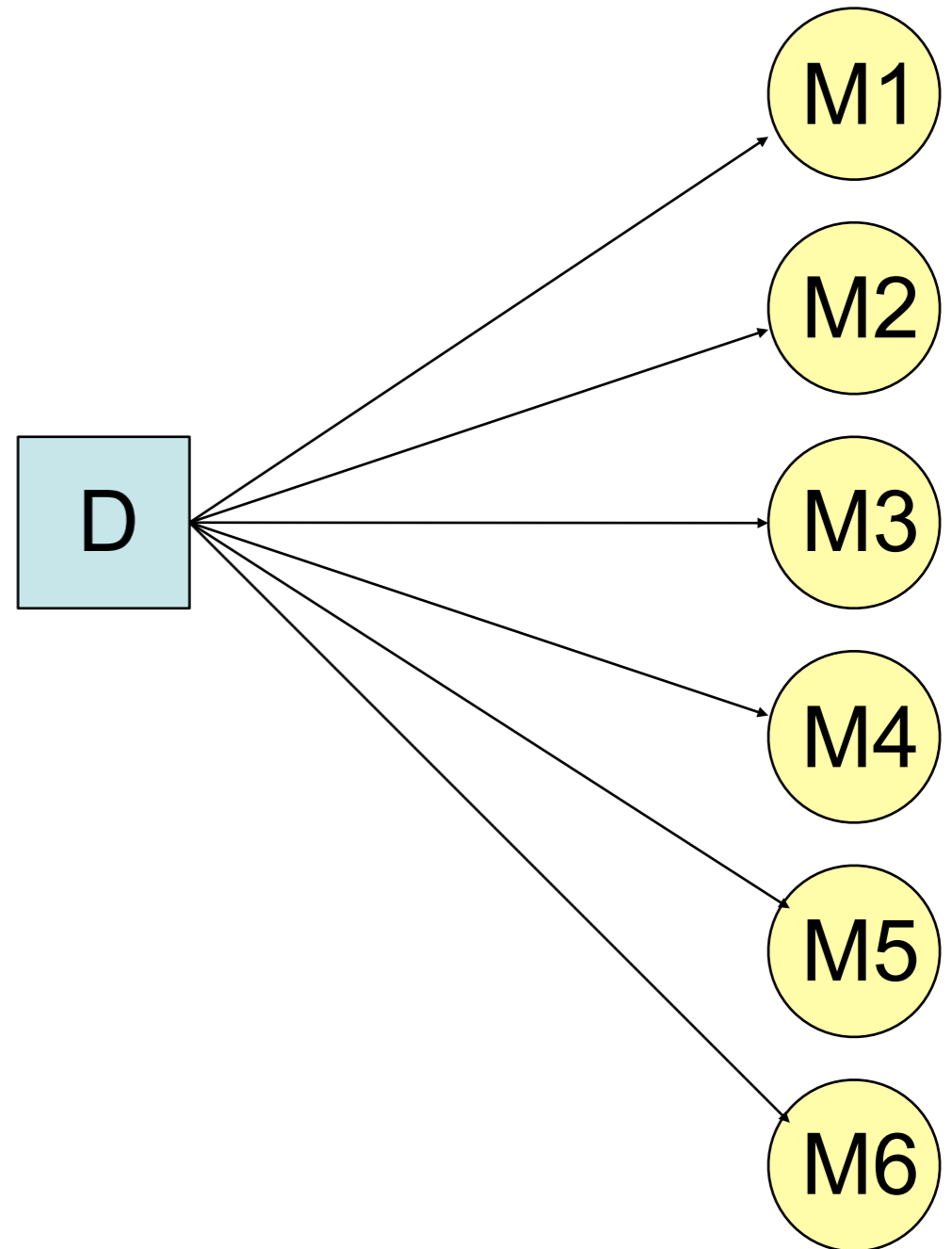

How certain are we after a test?

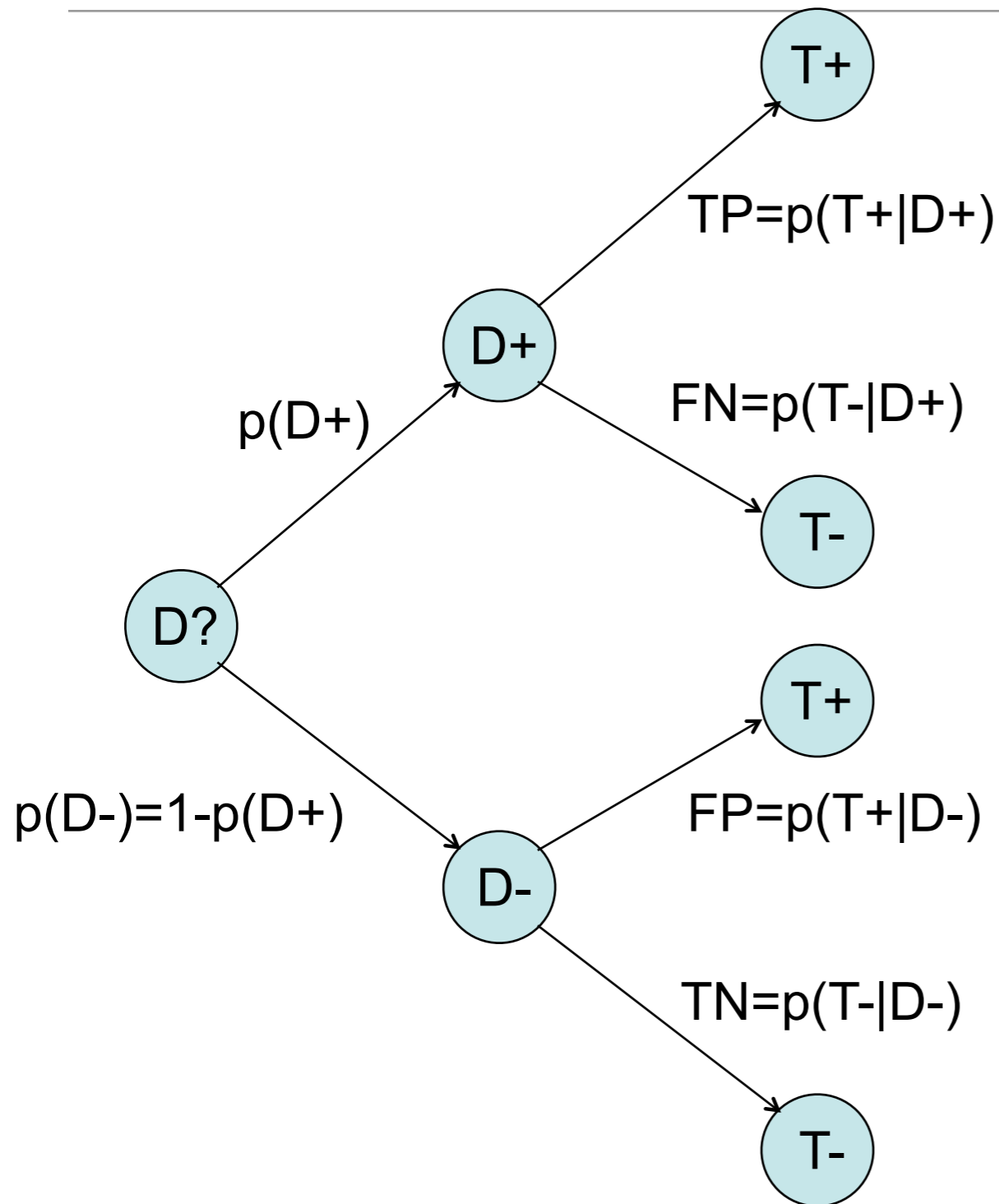

Imagine $P(D+) = .001$ (it's a rare disease)
 Accuracy of test = $P(T+|D+) = P(T-|D-) = .95$



Bayes' Rule:

Image is in the public domain.

$$P_{i+1}(D_j) = \frac{P_i(D_j)P(S|D_j)}{\sum_{k=1}^n P_i(D_k)P(S|D_k)}$$

Diagnostic Reasoning with Naive Bayes

- Exploit assumption of conditional independence among symptoms

$$P(S_1, S_2, \dots, S_n | D_i) = P(S_1 | D_i) P(S_2 | D_i) P(S_n | D_i)$$

- Sequence of observations of symptoms, S_i , each revise the distribution via Bayes' Rule

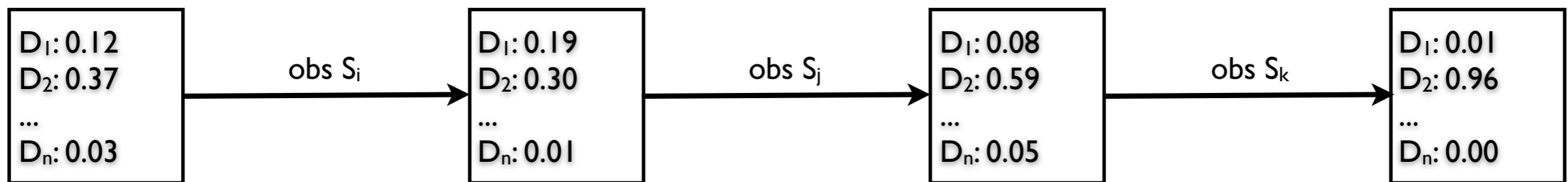

- After the j -th observation,

$$P^j(D_i | S_1, \dots, S_j) = \frac{P^{j-1}(D_i)P(S_j | D_i)}{P^{j-1}(S_j)} = \frac{P^{j-1}(D_i)P(S_j | D_i)}{\sum_{i=0}^n P^{j-1}(D_i)P(S_j | D_i)}$$

Odds-Likelihood

- In gambling, “3-to-1” odds means 75% chance of success

$$O = P/(1 - P) = P/\neg P$$

- $P = 0.5$ means $O=1$

- Likelihood ratio

- Odds-likelihood form of Bayes rule

$$L(S|D) = P(S|D)/P(S|\neg D)$$

- Log transform

$$O(D|S_1, \dots, S_n) = O(D)L(S_1|D) \dots L(S_n|D)$$

$$\begin{aligned} \log O(D|S_1, \dots, S_n) &= \log[O(D)L(S_1|D) \dots L(S_n|D)] \\ &= \log[O(D)] + \log[O(S_1|D)] + \dots + \log[O(S_n|D)] \\ &= W(D) + W(S_1|D) + \dots + W(S_n|D) \end{aligned}$$

Test Thresholds

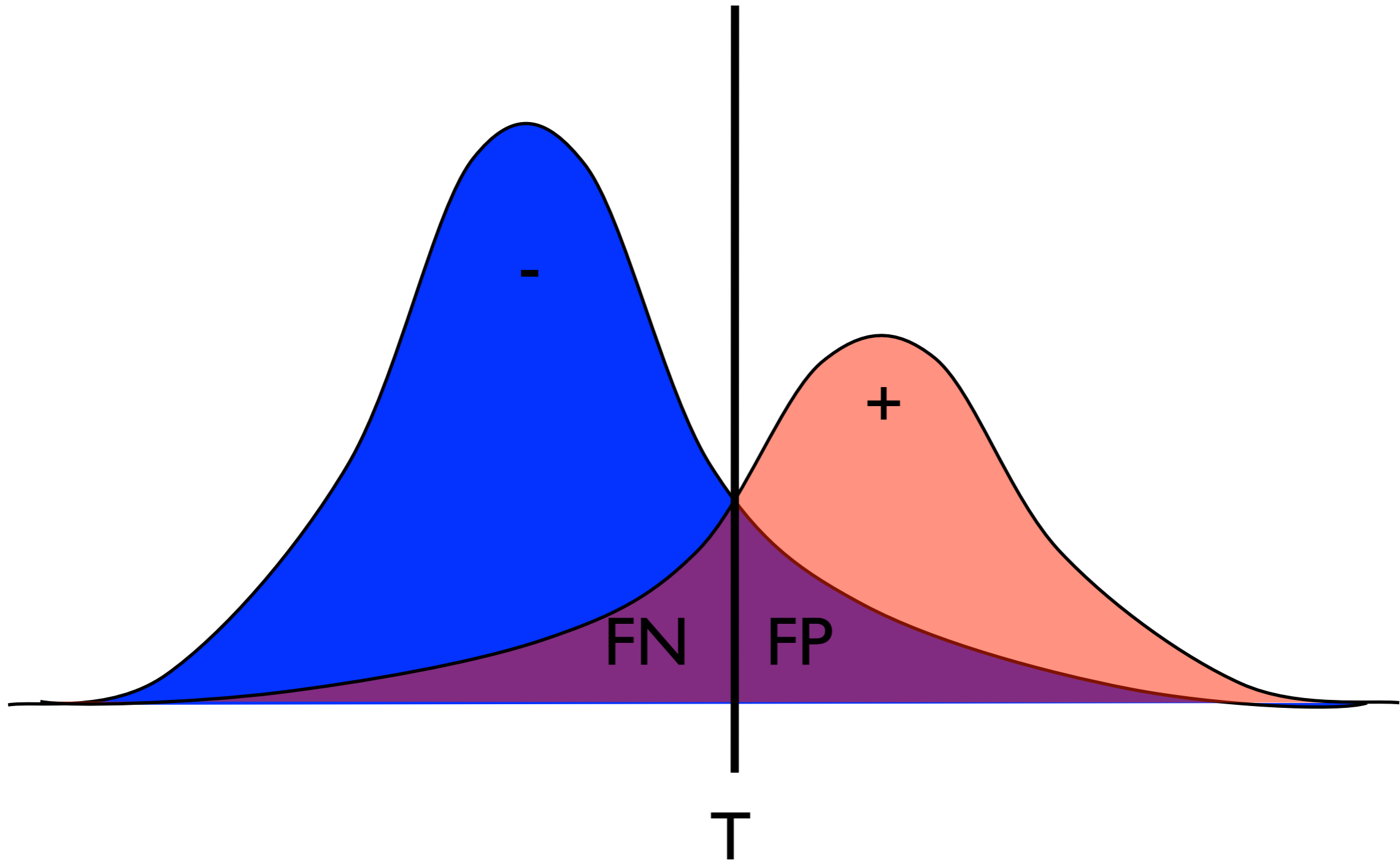

Wonderful Test

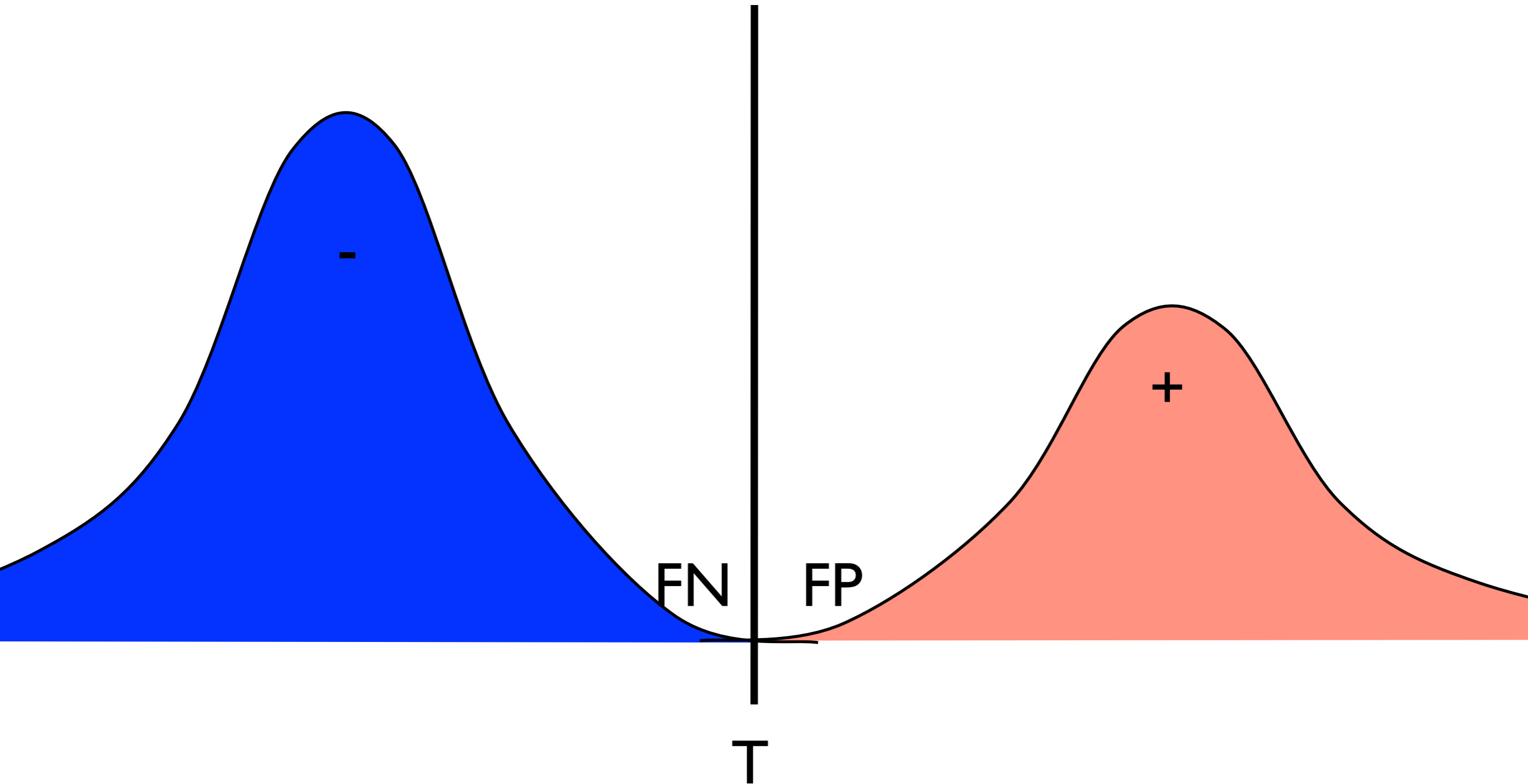

Test Thresholds Change Trade-off between Sensitivity and Specificity

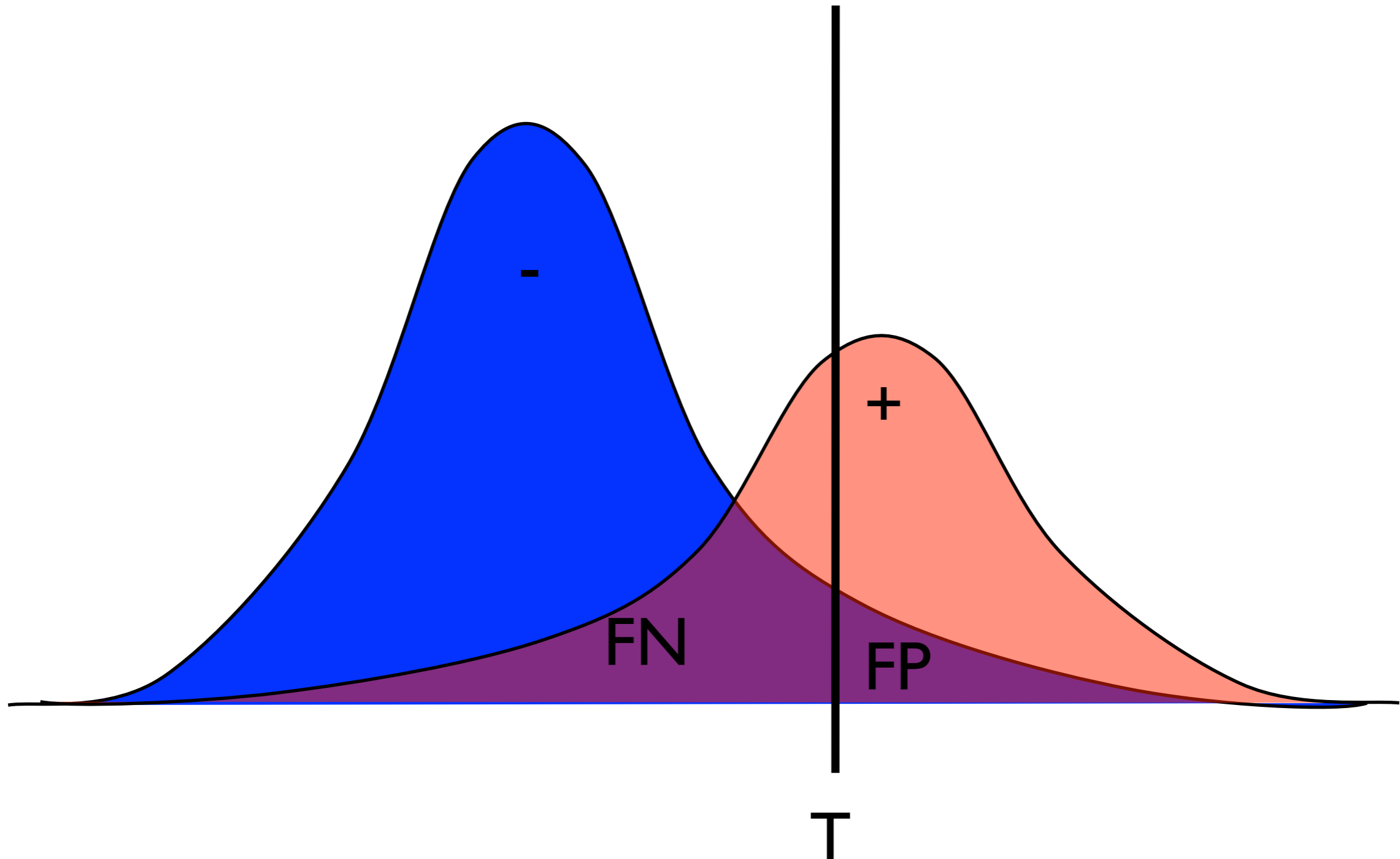

Receiver Operator Characteristic (ROC) Curve

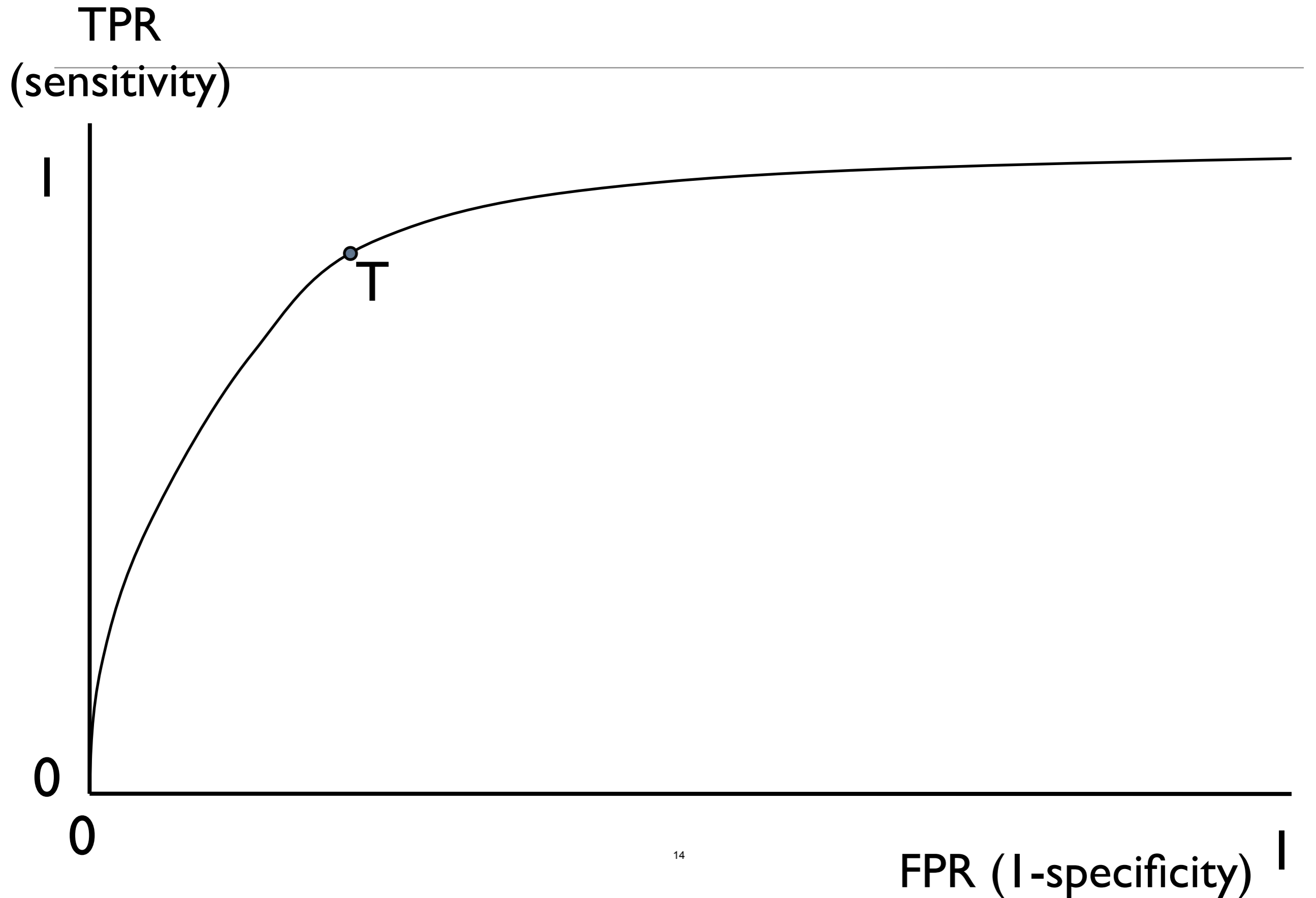

What makes a better test?

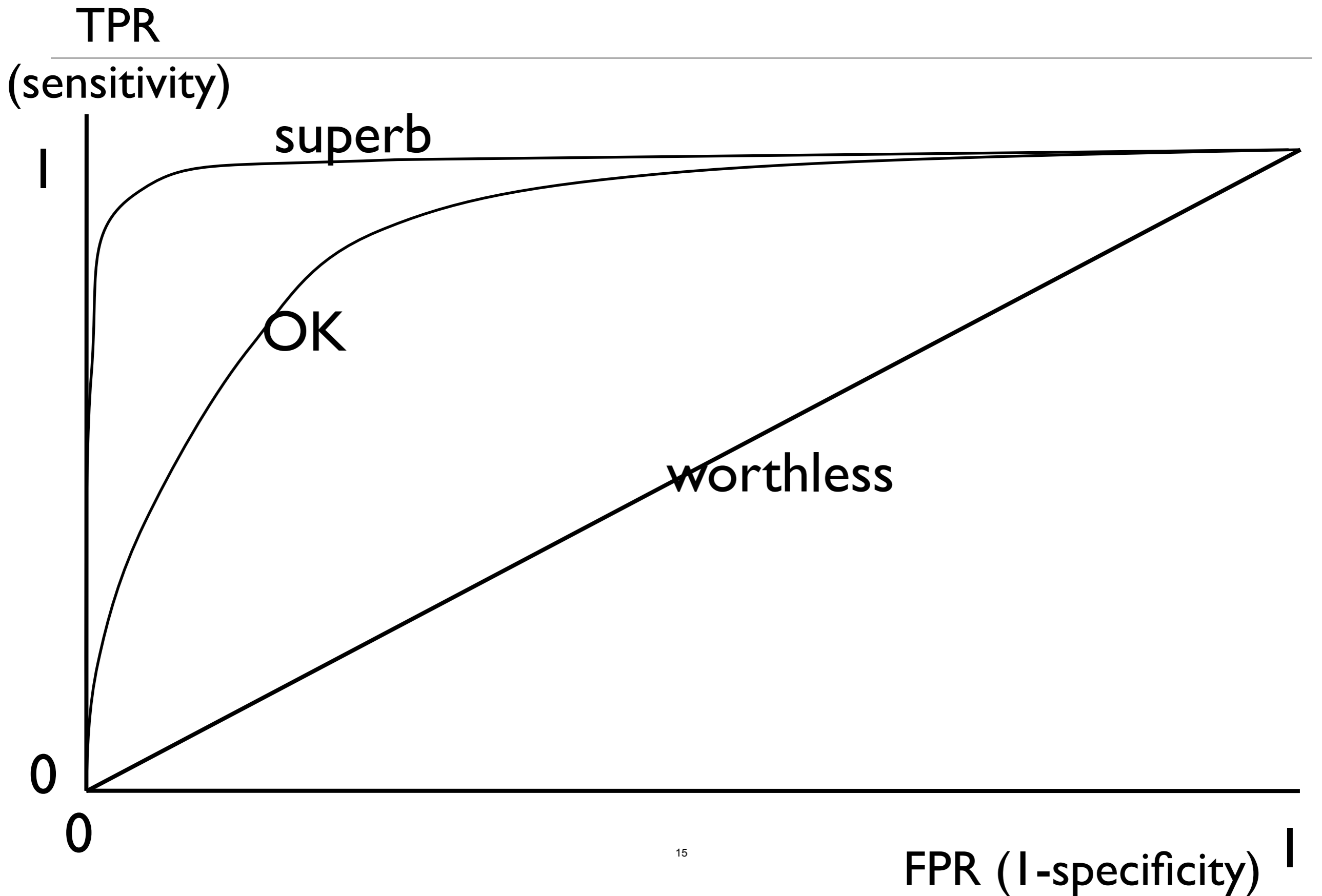

Rationality

- Every action has a cost
- Principle of rationality
 - Act to maximize expected utility — *homo economicus*
 - Or minimize loss
- Utility measures the value (“goodness”) of an outcome, e.g.,
 - Life vs. death
 - Quality-adjusted life years (QALYs)

Case of a Man with Gangrene

- From Pauker's "Decision Analysis Service" at New England Medical Center Hospital, late 1970's.
- Man with gangrene of foot
- Choose to amputate foot or treat medically
- If medical treatment fails, patient may die or may have to amputate whole leg.
- What to do? How to reason about it?

Decision Tree for Gangrene Case

(Different sense of "Decision Tree" from ML/Classification!)

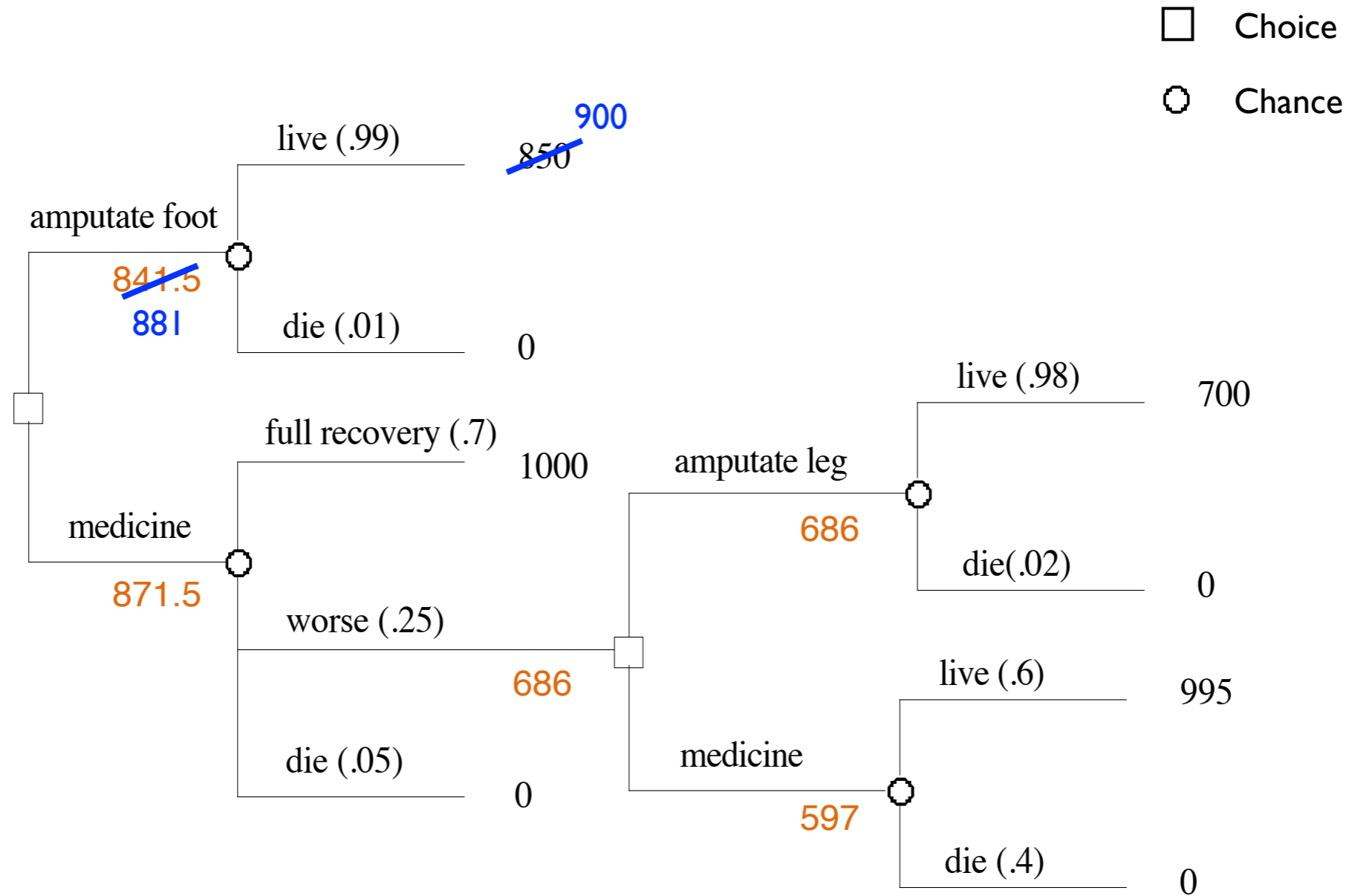

“Folding back” a Decision Tree

- The value of an outcome node is its utility
- The value of a chance node is the expected value of its alternative branches; i.e., their values weighted by their probabilities
- The value of a choice node is the maximum value of any of its branches

Where Do Utilities Come From?

- Standard gamble
 - Would you prefer (choose one of the following two):
 1. I chop off your foot
 2. We play a game in which a fair process produces a random number r between 0 and 1
 - If $r > 0.8$, I kill you; otherwise, you live on, healthy
 - If you're indifferent, that's the value of living without your foot!
 - I vary the 0.8 threshold until you are indifferent.
- Alas, difficult ascertainment problems!
 - Clearly depends on the individual
 - Not stable

Acute Renal Failure Program

- Differential Diagnosis of Acute Oliguric Renal Failure
 - “stop peeing”
- 14 potential causes, exhaustive and mutually exclusive
- 27 tests/questions/observations relevant to differential
 - “cheap”; therefore, ordering based on expected information gain
- 3 invasive tests (biopsy, retrograde pyelography, renal arteriography)
 - “expensive”; ordering based on (very naive) utility model
- 8 treatments (conservative, IV fluids, surgery for obstruction, steroids, antibiotics, surgery for clots, antihypertensive drugs, heparin)
 - expected outcomes are “better”, “unchanged”, “worse”

Question 5—What is the kidney size on plain film of the abdomen?

1. Small
2. Normal
3. Large
4. Very Large

Reply: 3

The current distribution is

<u>Disease</u>	<u>Probability</u>
OBSTR	0.80
FARF	0.12
PYE	0.04

Question 6—Was there a large fluid loss preceding the onset of oliguria?

Reply: No

The current distribution is

<u>Disease</u>	<u>Probability</u>
OBSTR	0.88
PYE	0.05
FARF	0.03

Question 7—What is the degree of Proteinuria?

1. 0
2. trace to 2+
3. 3+ to 4+

Reply: 1

The current distribution is

<u>Disease</u>	<u>Probability</u>
OBSTR	0.94
FARF	0.03
PYE	0.03

Question 8—Is there a history of prolonged hypotension preceding the onset of oliguria?

Reply: No

The current distribution is

<u>Disease</u>	<u>Probability</u>
OBSTR	0.96
PYE	0.03

Figure 1. Typical interactive dialogue between the physician and the phase I computer program. The final diagnosis, which was arrived at after eight questions were asked, was urinary tract obstruction.

Demo of Acute Renal Failure Program

- Only the diagnostic portion
 - Original program also solved the decision analysis problem of what to do next
 - BADLY!
- 1990s GUI instead of 1970s terminal interface

“It thinks just the way I do!”

Bipartite Graph Model

- Multiple diseases
- Diseases are independent
- Manifestations depend only on which diseases are present
- Thus, they are conditionally independent

- This is a type of Bayes Network
- Computationally intractable
 - Complexity exponential in number of undirected cycles

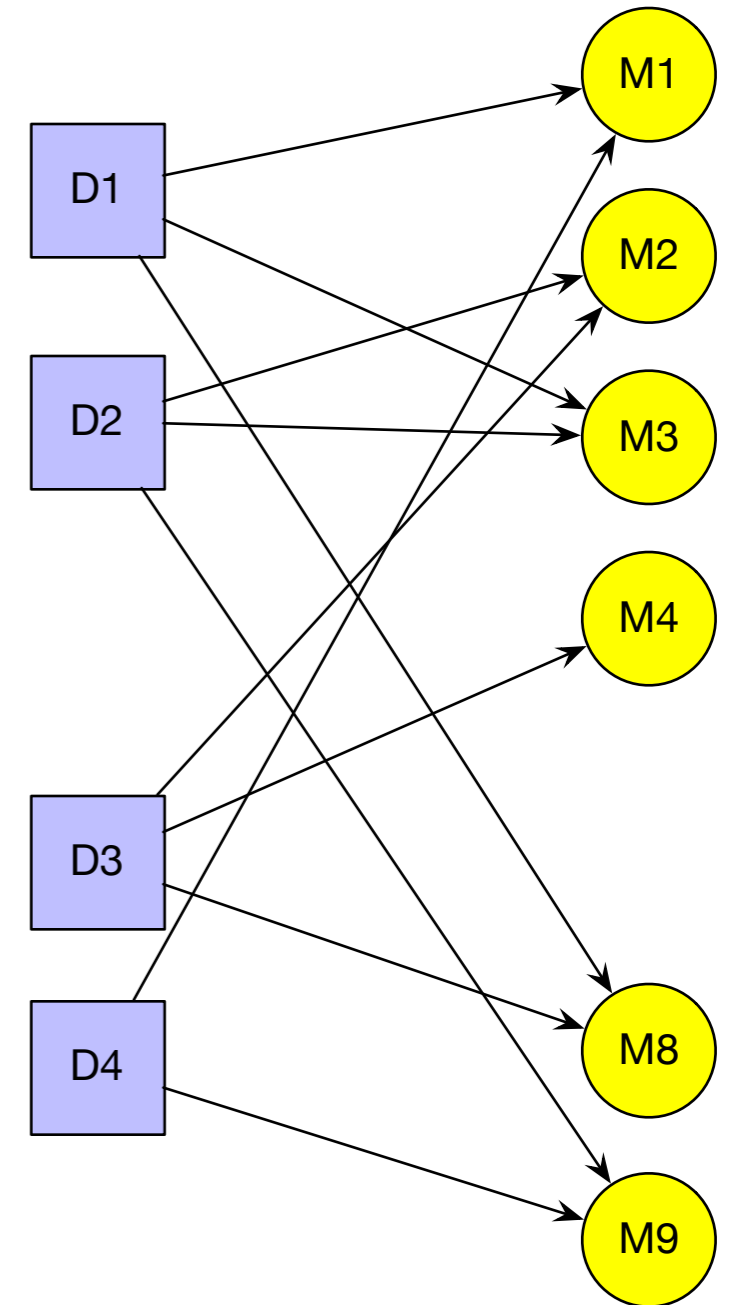

Dialog/Internist/QMR ~1982

- ~500 diseases
 - (est. 70-75% of major diagnoses in internal medicine)
- ~3,500 manifestations
- (~15 man-years)

- By 1997, commercialized QMR had 766 Dx and 5498 Mx

Table 4. A Sample Manifestations List.*

DISPLAY WHICH MANIFESTATION LIST?	
ALCOHOLIC HEPATITIS	
AGE 16 TO 25 ...	0 1
AGE 26 TO 55 ...	0 3
AGE GTR THAN 55 ...	0 2
ALCOHOL INGESTION RECENT HX ...	2 4
ALCOHOLISM CHRONIC HX ...	2 4
SEX FEMALE ...	0 2
SEX MALE ...	0 4
URINE DARK HX ...	1 3
WEIGHT LOSS GTR THAN 10 PERCENT ...	0 3
ABDOMEN PAIN ACUTE ...	1 2
ABDOMEN PAIN COLICKY ...	1 1
ABDOMEN PAIN EPIGASTRIUM ...	1 2
ABDOMEN PAIN NON COLICKY ...	1 2
ABDOMEN PAIN RIGHT UPPER QUADRANT ...	1 3
ANOREXIA ...	0 4
DIARRHEA ACUTE ...	1 2
MYALGIA ...	0 3
VOMITING RECENT ...	0 4
ABDOMEN BRUIT CONTINUOUS RIGHT UPPER QUADRANT ...	1 2
ABDOMEN BRUIT SYSTOLIC RIGHT UPPER QUADRANT ...	1 2
ABDOMEN TENDERNESS RIGHT UPPER QUADRANT ...	2 4
CONJUNCTIVA AND/OR MOUTH PALLOR ...	1 2
FECES LIGHT COLORED ...	1 2
FEVER ...	0 4
HAND(S) DUPUYTRENS CONTRACTURE(S) ...	1 2
JAUNDICE ...	1 3
LEG(S) EDEMA BILATERAL SLIGHT OR MODERATE ...	1 2
LIVER ENLARGED MASSIVE ...	1 2
LIVER ENLARGED MODERATE ...	1 3
LIVER ENLARGED SLIGHT ...	1 2
PAROTID GLAND(S) ENLARGED ...	1 2

Data in QMR

- For each Dx
 - List of associated Mx
 - with Evoking strength & Frequency
 - ~75 Mx per Dx
- For each Mx
 - Importance

Data in QMR

Frequency (Fr)	
1	Mx occurs rarely in Dx
2	Mx occurs in a substantial minority of cases of Dx
3	Mx occurs in roughly half of cases of Dx
4	Mx occurs in a substantial majority of cases of Dx
5	Mx occurs in essentially all cases of Dx

Evoking Strength (Ev)	
0	Nonspecific
1	Dx is a rare or unusual cause of Mx
2	Dx causes a substantial minority of instances of Mx
3	Dx is the most common but not overwhelming cause of Mx
4	Dx is the overwhelming cause of Mx
5	Mx is <i>pathognomonic</i> for Dx

Importance (Im)	
1	Usually unimportant; occurs often in normal patients
2	May be important but can often be ignored
3	Medium importance, but unreliable indicator of disease
4	High importance, rarely disregarded
5	Absolutely must be explained by final diagnosis

Abductive Logic in QMR

- List Mx of a case
 - Many demonstrated on NEJM Clinico-Pathological Conference cases
 - These are quite complex and challenging to doctors
- Evoke Dx's with high evoking strengths from Mx's
- Score Dx's
 - Positive:
 - Evoking strength of observed Manifestations
 - Scaled Frequency of causal links from confirmed Hypotheses
 - Scaling roughly exponential
 - Negative:
 - Frequency of predicted but absent Manifestations
 - Importance of unexplained Manifestations
- Form a differential around highest-scoring Dx

QMR Partitioning

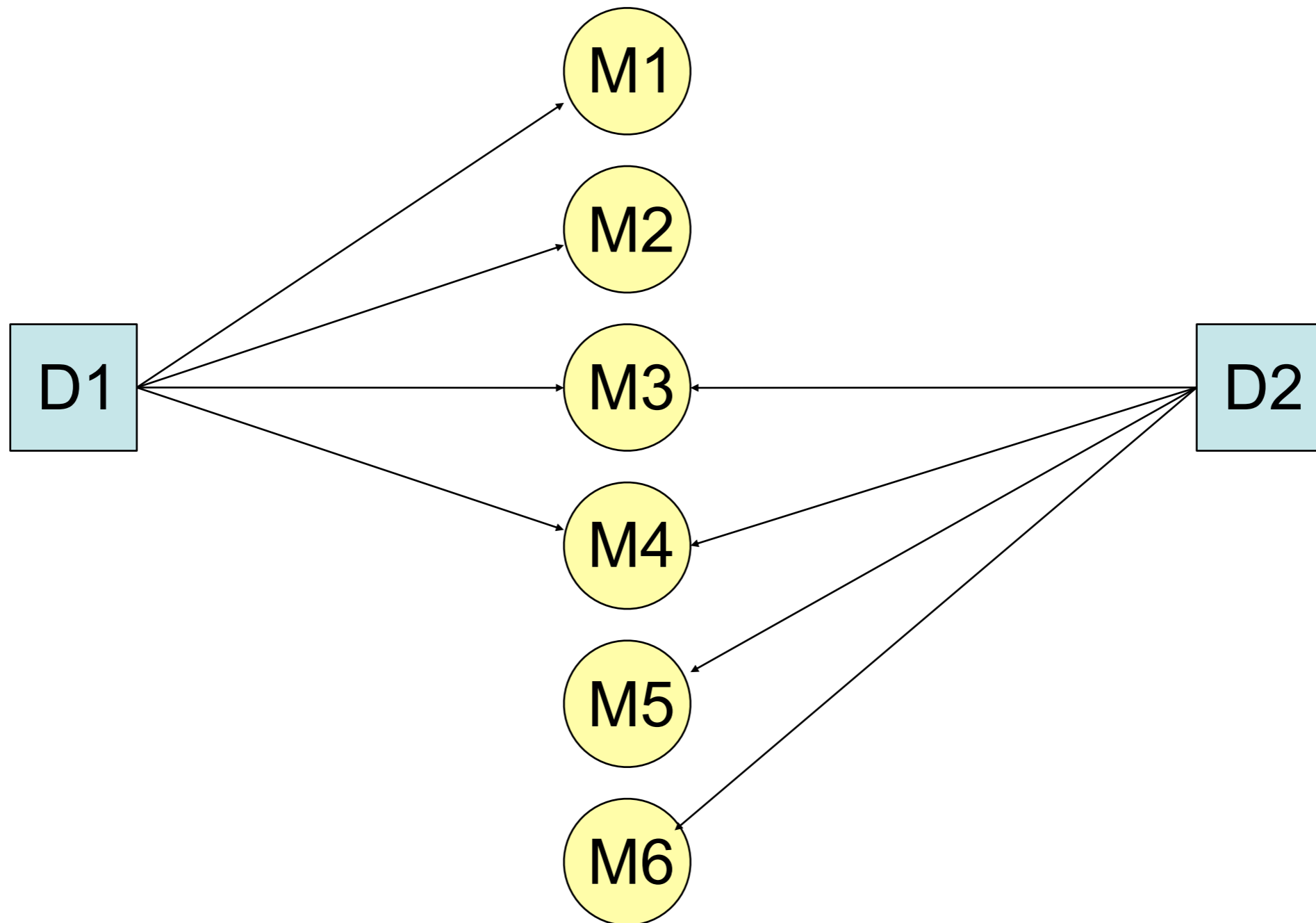

Competitors

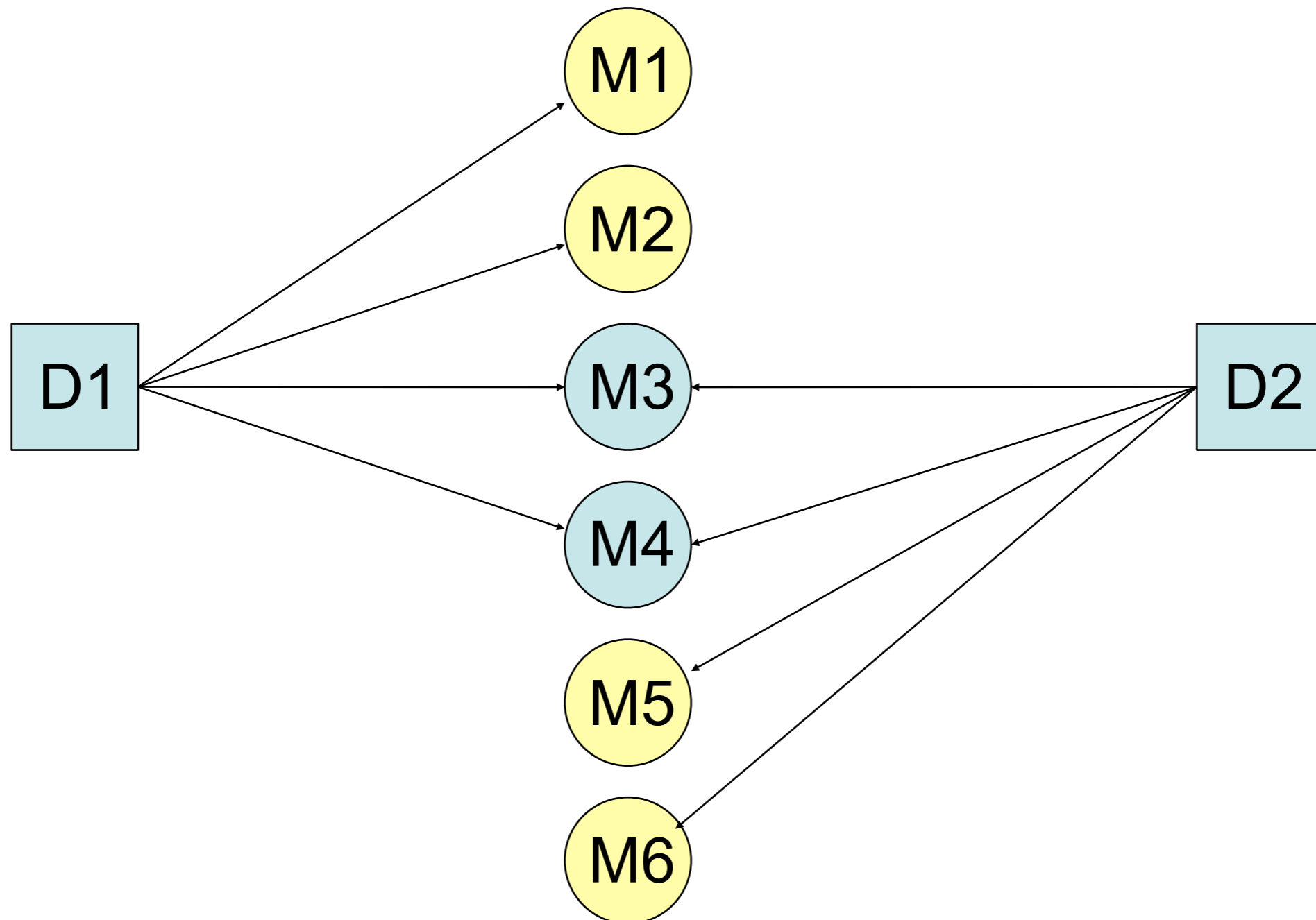

Still Competitors

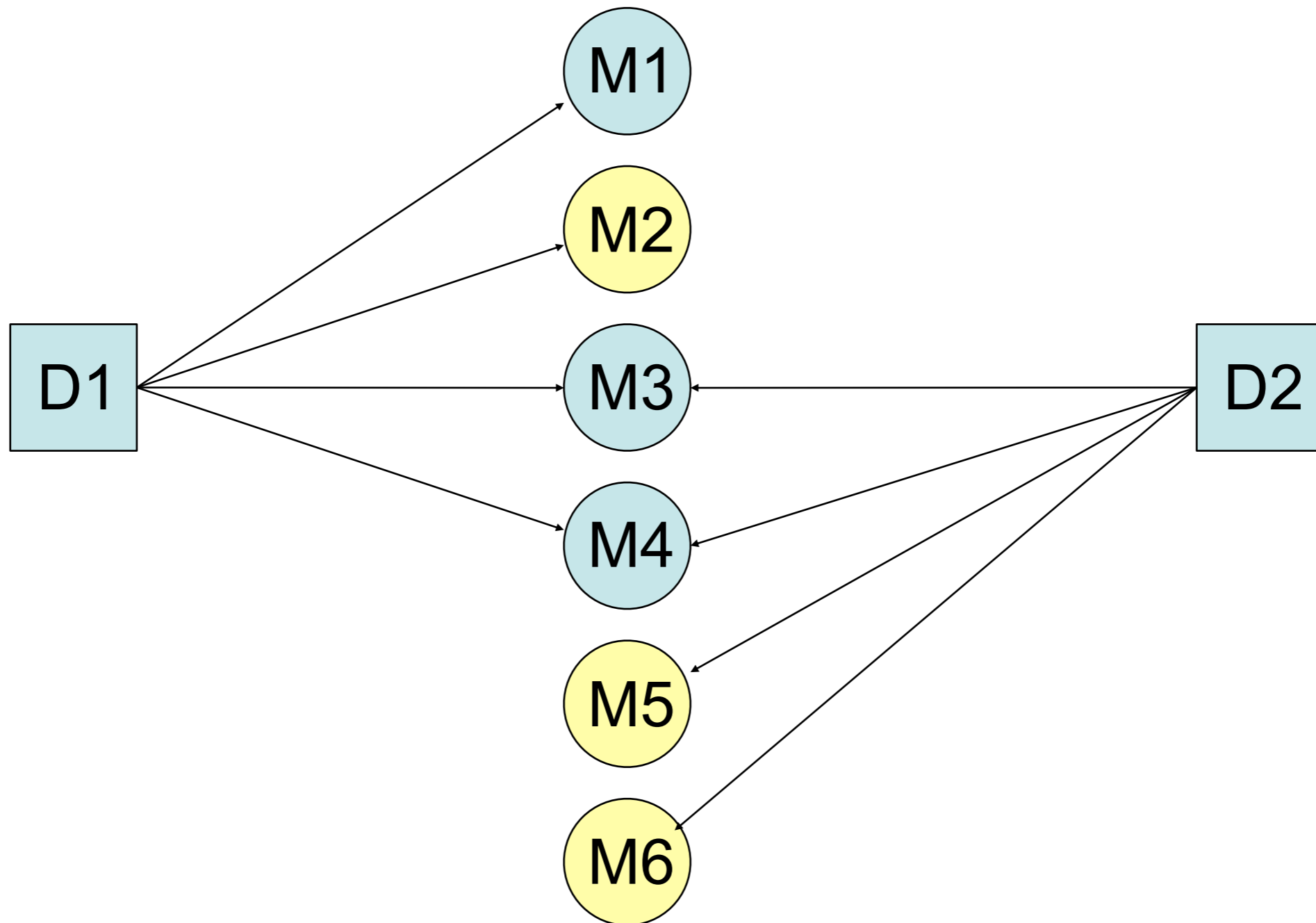

Probably Complementary

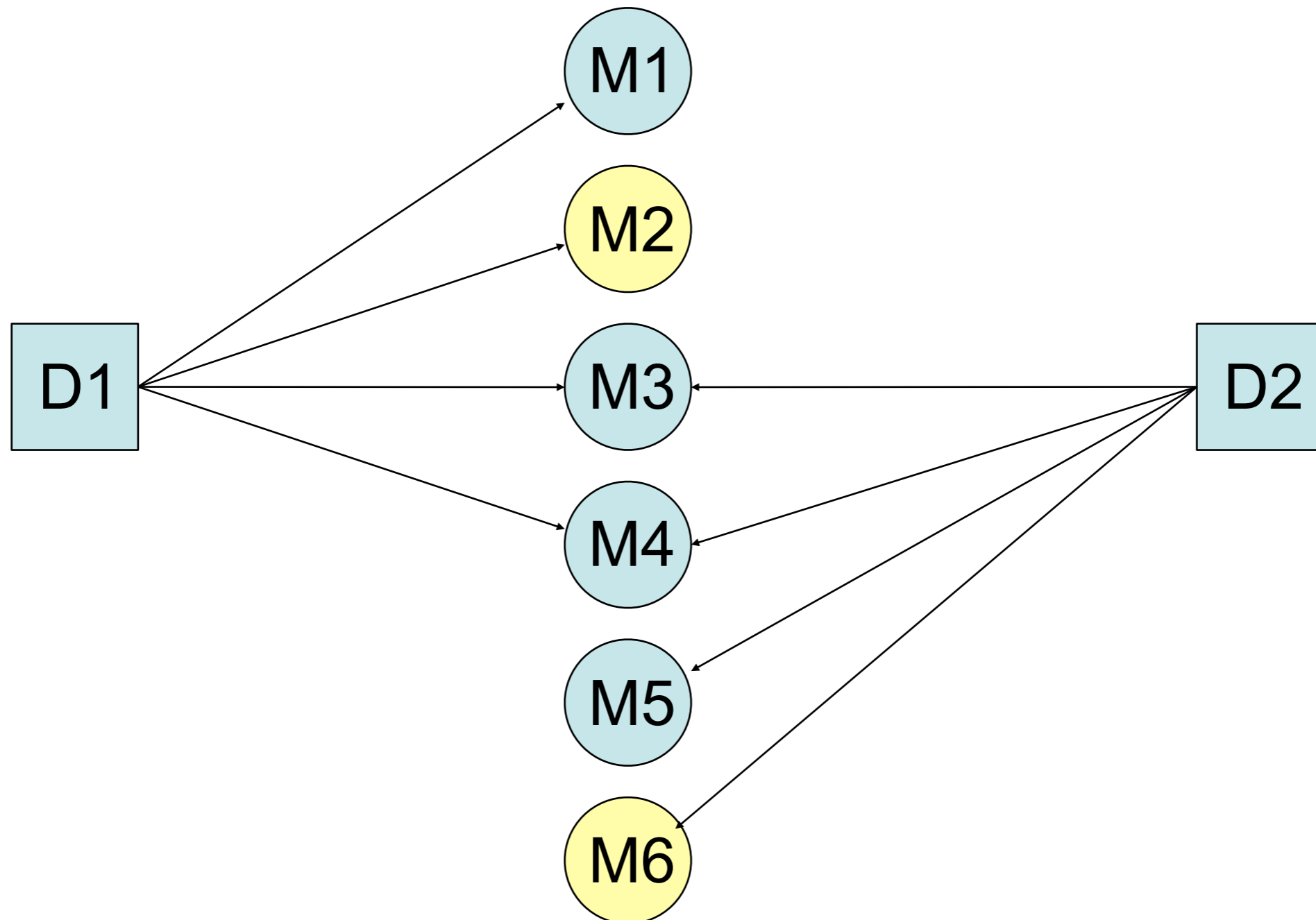

Multi-Hypothesis Diagnosis

- Set aside complementary hypotheses
 - ... and manifestations predicted by them
- Solve diagnostic problem among competitors
 - differential determines questioning strategy: *pursue, rule-out, differentiate, ...*
- Eliminate confirmed hypotheses and manifestations explained by them
- Repeat as long as there are coherent problems among the remaining data

Table 5. Summary of Results for Major Diagnoses in 19 Cases Used in the INTERNIST-I Evaluation.

CATEGORY	INTERNIST-I	CLINICIANS	DISCUSSANT
	<i>no. of instances</i>		
<i>Total possible diagnoses</i>	43	43	43
Definitive, correct	17	23	29
Tentative, correct	8	5	6
Failed to make correct diagnosis	18	15	8
Definitive, incorrect	5	8	11
Tentative, incorrect	6	5	2
Total no. of incorrect diagnoses	11	13	13
Total no. of errors in diagnosis	29	28	21

1990s Evaluation of Diagnostic Systems

- Evaluate: QMR, DXplain, Iliad, Meditel
- 105 cases (based on actual patients) created by 10 experts
- Results:
 - Coverage — fraction of real diagnoses included in program's KB
 - Correct — fraction of program's dx considered correct by experts
 - Rank — rank order of correct dx in program's list
 - Relevance — fraction of program's dx considered worthwhile by experts
 - Comprehensiveness — number of experts' dx included in program's top 20
 - Additional — “value added” dx by program

Table 1. Performance Scores of the Computer-Based Diagnostic Systems.

VARIABLE AND SAMPLE USED*	DXPLAIN	ILIAD	MEDITEL	QMR	OVERALL ANALYSIS OF VARIANCE	P VALUE	SIGNIFICANT PAIRWISE COMPARISONS†
	<i>mean (95 percent confidence interval)</i>						
Diagnosis in Knowledge Base	0.91 (0.86–0.97)	0.76 (0.68–0.85)	0.85 (0.78–0.92)	0.73 (0.65–0.82)	$\chi^2 = 20.32$	<0.001	D vs. I, D vs. Q, M vs. Q
Correct Diagnosis							
105 cases	0.69 (0.60–0.78)	0.61 (0.52–0.70)	0.71 (0.62–0.79)	0.52 (0.43–0.62)	$\chi^2 = 11.58$	0.009	D vs. Q, M vs. Q
63 cases	0.79 (0.69–0.90)	0.76 (0.65–0.87)	0.89 (0.81–0.97)	0.71 (0.60–0.83)	$\chi^2 = 7.06$	0.070	—
Rank‡							
Diagnosis in program studied§	12.4 (9.5–15.3)	10.4 (8.0–12.8)	13.3 (10.5–16.1)	6.6 (3.0–10.3)	—	—	—
Diagnosis in all four programs¶	11.7 (8.3–15.1)	10.2 (7.5–12.9)	12.0 (8.8–15.3)	5.4 (3.7–7.1)	—	—	—
Relevance							
105 cases	0.24 (0.21–0.26)	0.19 (0.16–0.21)	0.22 (0.20–0.24)	0.37 (0.31–0.42)	F = 15.80	<0.001	Q vs. D, Q vs. M, Q vs. I, D vs. I, M vs. I
63 cases	0.26 (0.23–0.29)	0.21 (0.17–0.24)	0.23 (0.20–0.26)	0.46 (0.39–0.54)	F = 16.45	<0.001	Q vs. D, Q vs. M, Q vs. I, D vs. I
Comprehensiveness							
105 cases	0.38 (0.34–0.43)	0.25 (0.21–0.29)	0.38 (0.33–0.43)	0.28 (0.23–0.32)	F = 13.99	<0.001	D vs. I, D vs. Q, M vs. I, M vs. Q
63 cases	0.38 (0.33–0.44)	0.27 (0.22–0.32)	0.39 (0.32–0.46)	0.30 (0.25–0.35)	F = 5.05	0.004	D vs. I, D vs. Q, M vs. I, M vs. Q
Additional Diagnoses							
105 cases	2.3 (1.8–2.7)	2.0 (1.6–2.4)	2.1 (1.8–2.4)	1.8 (1.4–2.2)	F = 1.65	0.182	—
63 cases	2.6 (2.0–3.1)	2.2 (1.7–2.8)	2.2 (1.8–2.5)	2.0 (1.4–2.5)	F = 1.02	0.392	—

*The analyses of 105 cases were based on all cases included in the test, whereas the analyses of 63 cases were limited to the cases whose diagnoses were included in the knowledge base of all four programs.

†D denotes Dxpain, I Iliad, Q QMR, and M Meditel.

‡This variable could not be tested for significance because the sample varied in size according to the program used.

§This analysis included variable numbers of cases (72 for Dxpain, 64 for Iliad, 74 for Meditel, and 55 for QMR).

¶This analysis included variable numbers of cases (50 for Dxpain, 48 for Iliad, 56 for Meditel, and 45 for QMR).

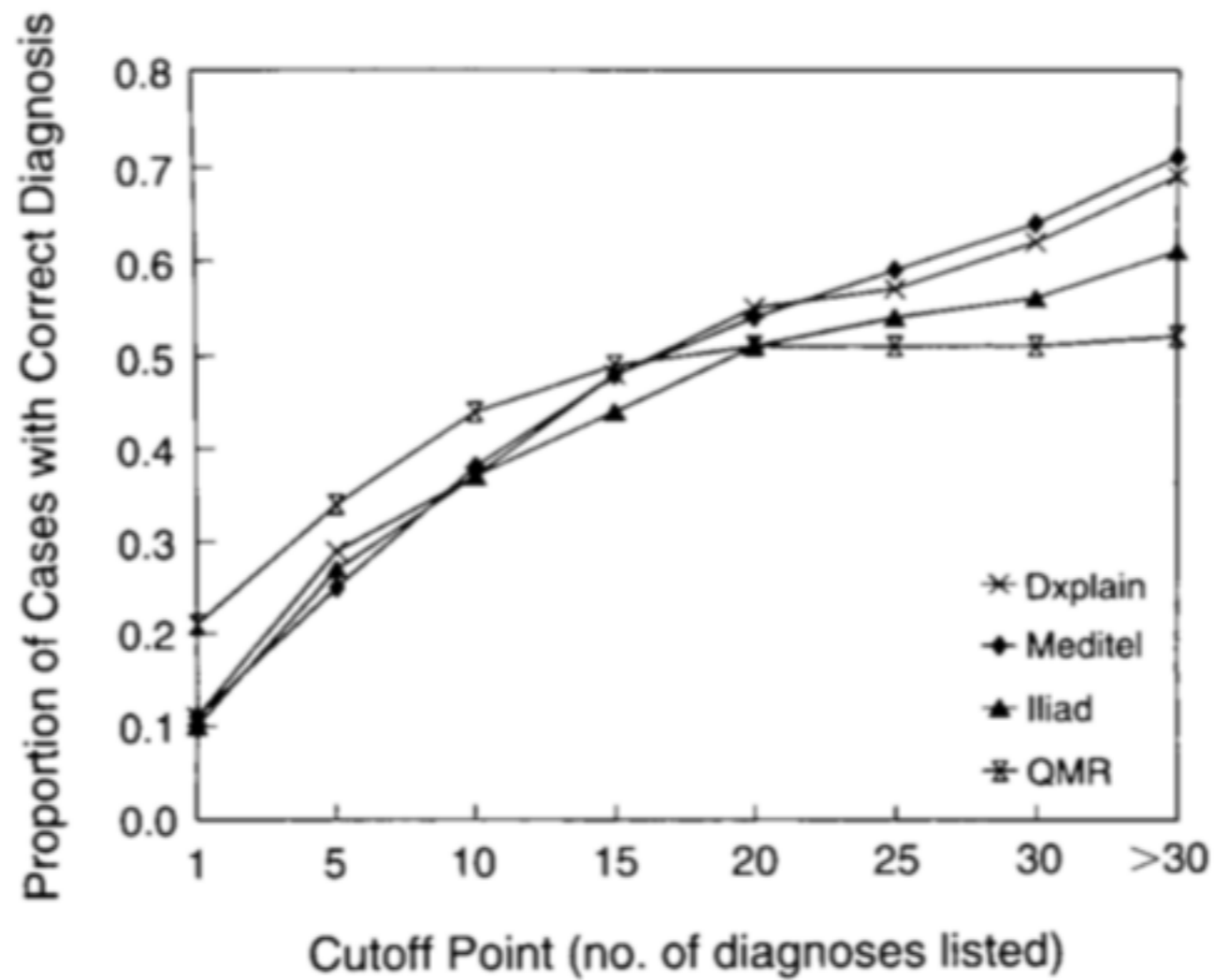
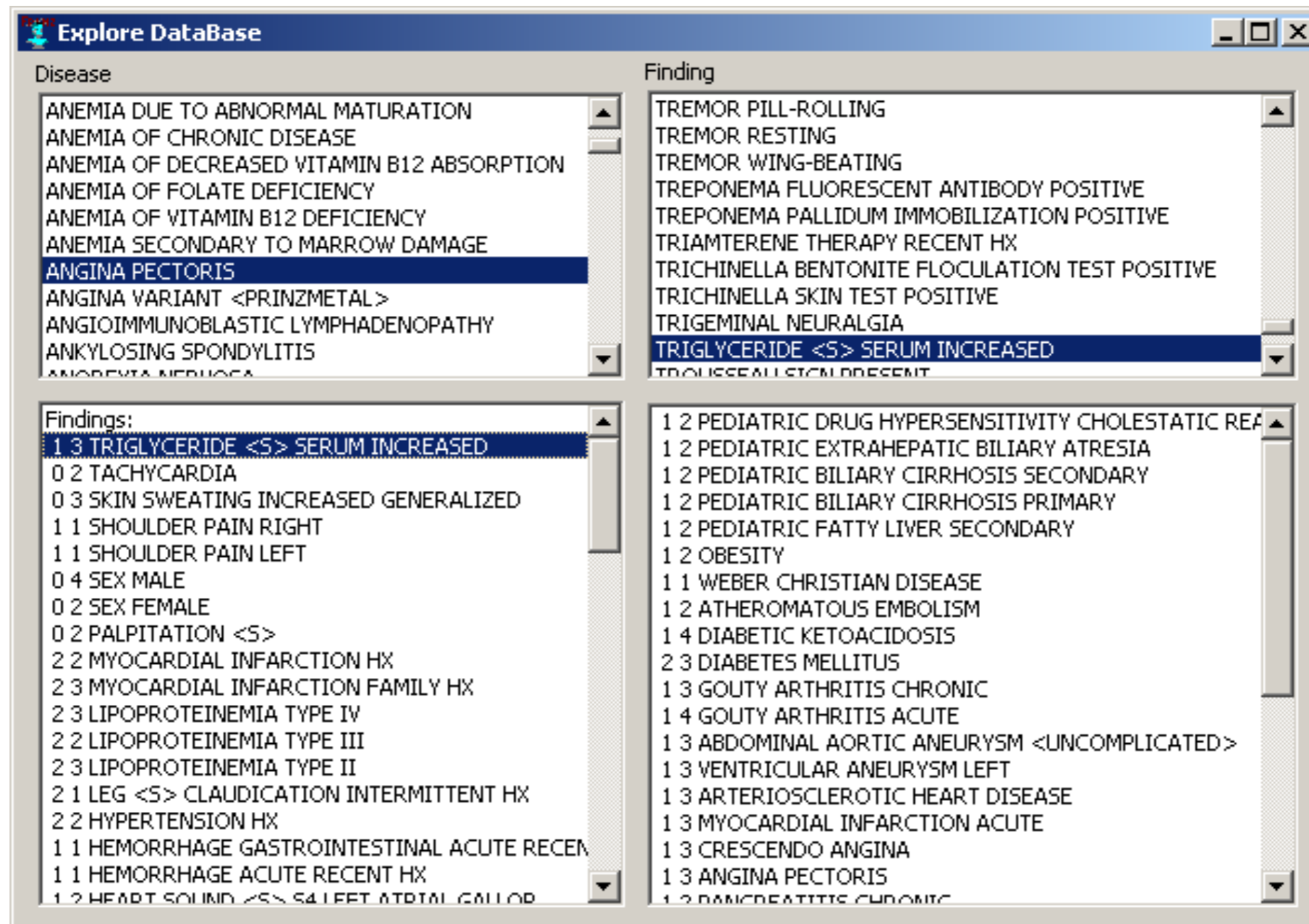

Figure 1. Proportion of Cases with a Correct Diagnosis in the Computer, According to the Cutoff Point Establishing the Numbers of Diagnoses Listed.

Evaluation Bottom Line

- ... long lists of potential diagnoses. ... many that a knowledgeable physician would regard as not being particularly helpful
- ... each program suggested some diagnoses, though not highly likely ones, that the experts later agreed were worthy of inclusion in the differential diagnosis
- None performed consistently better or worse on all the measures
- Although the sensitivity and specificity ... were not impressive, the programs have additional functions not evaluated
 - interactive display of signs and symptoms associated with diseases
 - relative likelihood of each dx (study only used ranking)
- Need to study effect of such programs on {physician, computer} team

QMR Database



Example Case

Internist Data Summary

Internist Reconstruction -- Data Summary

Diagnose

Manifestations PRESENT:

- ABDOMEN DISTENTION
- ABDOMEN FLUID WAVE
- AGE GTR THAN 55
- ALKALINE PHOSPHATASE BLOOD GTR THAN 2 TIMES NORMAL
- AMMONIA BLOOD INCREASED
- ANOREXIA
- ARTHRITIS HX
- ASCITIC FLUID PROTEIN 3 GRAM <S> PER DL OR LESS
- ASCITIC FLUID WBC 100 TO 500
- ASTERIXIS
- BILIRUBIN BLOOD CONJUGATED INCREASED
- BILIRUBIN URINE PRESENT
- CHEST PAIN LATERAL EXACERBATION WITH BREATHING
- CHEST PAIN LATERAL SHARP
- DEPRESSION HX
- DYSPNEA ABRIIPT ONSET

Remove Present

Manifestations ABSENT:

- ALCOHOLISM CHRONIC HX
- ASCITIC FLUID AMYLASE INCREASED
- ASCITIC FLUID CYTOLOGY POSITIVE
- ASCITIC FLUID LDH GTR THAN 500
- DIARRHEA CHRONIC
- ESOPHAGUS BARIUM MEAL VARICES
- FECES BLACK TARRY
- FEVER
- HEMATOCRIT BLOOD LESS THAN 35
- PRESSURE VENOUS CERVICAL INCREASED ON INSPECTION
- STOMACH BARIUM MEAL ULCER CRATER <S>
- T3 RESIN UPTAKE INCREASED
- T4 FREE BLOOD INCREASED
- UREA NITROGEN BLOOD 30 TO 59
- URIC ACID BLOOD INCREASED

Remove Absent

Initial Solution

Diagnostic Results

Problem:

- 94 HEPATITIS CHRONIC ACTIVE
- 119 PEDIATRIC HEPATITIS CHRONIC ACTIVE
- 136 MACRONODAL CIRRHOSIS <POSTNECROTIC>
- 158 BILIARY CIRRHOSIS PRIMARY
- 178 PEDIATRIC BILIARY CIRRHOSIS PRIMARY

Complementary:

- 143 MICRONODAL CIRRHOSIS <LAENNECS>
- 162 HEPATITIS ACUTE VIRAL
- 170 CHOLANGIOCARCINOMA <INTRAHEPATIC NON HILAR>
- 178 HEPATIC AMYLOIDOSIS

Shelf:

- ABDOMEN DISTENTION
- ARTHRITIS HX
- CHEST PAIN LATERAL EXACERBATION WITH BREATHING
- CHEST PAIN LATERAL SHARP
- FECES GUAIAC TEST POSITIVE
- PLEURAL FRICTION RUB
- WEIGHT INCREASE RECENT HX

Explained:

- AGE GTR THAN 55
- ALKALINE PHOSPHATASE BLOOD GTR THAN 2 TIMES NORMAL
- ANOREXIA
- BILIRUBIN BLOOD CONJUGATED INCREASED
- BILIRUBIN URINE PRESENT
- FECES LIGHT COLORED
- HAND <S> PALMAR ERYTHEMA
- IMMUNOELECTROPHORESIS SERUM IGA INCREASED
- IMMUNOELECTROPHORESIS SERUM IGG INCREASED

Absent:

- DIARRHEA CHRONIC
- FEVER
- HEMATOCRIT BLOOD LESS THAN 35

Unexplained:

- ABDOMEN DISTENTION
- ABDOMEN FLUID WAVE
- AMMONIA BLOOD INCREASED
- ARTHRITIS HX
- ASCITIC FLUID PROTEIN 3 GRAM <S> PER DL OR LESS
- ASCITIC FLUID WBC 100 TO 500

Askable:

- ABDOMEN PAIN CHRONIC
- ABDOMEN PAIN EPIGASTRIUM
- ABDOMEN PAIN EPIGASTRIUM UNRELIEVED BY ANTACID
- ABDOMEN PAIN EXACERBATION WITH MEAL <S>
- ABDOMEN PAIN NON COLICKY
- ABDOMEN PAIN PRESENT
- ABDOMEN PAIN RIGHT UPPER QUADRANT
- ABDOMEN TENDERNESS PRESENT
- ABDOMEN TENDERNESS RIGHT UPPER QUADRANT
- ACTIVATED PARTIAL THROMBOPLASTIN TIME INCREASED
- AGE 16 TO 25
- AGE 26 TO 55
- ALBUMIN SERUM DECREASED
- ALKALINE PHOSPHATASE BLOOD INCREASED NOT OVER 2 TIMES NORMA

QMR-DT

- Interpret QMR data as a BN, with assumptions
 - Bipartite graph: marginal independence of Dx, conditional independence of Mx
 - Binary Dx and Mx
 - “Causal independence” —leaky *noisy-OR*
 - No distinction between Mx that predispose to a Dx and those that are a consequence of the Dx
 - Priors on Dx estimated from health statistics
 - problem of mapping QMR Dx names to ICD-9-CM
 - QMR treats age and gender as Mx, but QMR-DT conditions priors on them
 - No Evoking strengths are used
 - Estimate “leak” for each Mx from Importance values
- Use iterative diagnosis similar to QMR’s setting aside competitors, with Dx-Dx links altering priors on successive rounds
- Likelihood weighting to estimate posteriors

Symptom Checkers

- Demo *K Health*
- BMJ article, 2015
 - 23 symptom checkers
 - 45 standardized patient vignettes
 - 3 levels of urgency:
 - emergent care needed: e.g., pulmonary embolism
 - non-emergent care reasonable: e.g., otitis media (ear ache)
 - self-care reasonable: e.g., viral infection
 - Goals
 - if diagnosis given, is right answer within top 20 (n=770)
 - if triage given, is it the right level of urgency (n=532)
 - Correct dx first in 34% of cases, within top 20 in 58%
 - Correct triage in 57% (80% in emergent, 55% non-emergent, 33% self-care)
 - different systems ranged from 33% to 78% average accuracy

Symptom Checkers: BMJ conclusions

- The public is increasingly using the internet for self diagnosis and triage advice, and there has been a proliferation of computerized algorithms called symptom checkers that attempt to streamline this process
- Despite the growth in use of these tools, their clinical performance has not been thoroughly assessed
- Our study suggests that symptom checkers have deficits in both diagnosis and triage, and their triage advice is generally risk averse

Rationality under Resource Constraints

- Utility comes not only from the ultimate “patient” but from reasoning about the computational process
- McGyver’s utilities drop suddenly under deadline constraints
- Partial computation
 - Any-time algorithms
 - Simplify model
 - Approximate
- Kahneman
 - Fast: reflex, rules
 - Slow: deliberative

Meta-level Reasoning about How to Reason

- “the expected value of computation as a fundamental component of reflection about alternative inference strategies”
 - alternative methods (e.g., QMR’s question-asking strategies)
 - degree of refinement (e.g., incremental algorithms can stop early)
- Value of information, value of computation, value of experimentation

A Time-Pressured Decision Problem

© Horvitz, E., Cooper, G. F., & Heckerman, D. All rights reserved. This content is excluded from our Creative Commons license. For more information, see <https://ocw.mit.edu/help/faq-fair-use/>

- decision-theoretic metareasoning
- belief network representing propositions and dependencies in intensive care physiology
- close-up on “Respiratory Status” node and its relationship to current decision problem
 - “A 75yo woman in ICU has sudden breathing difficulties”
 - Should we start mechanical ventilation?

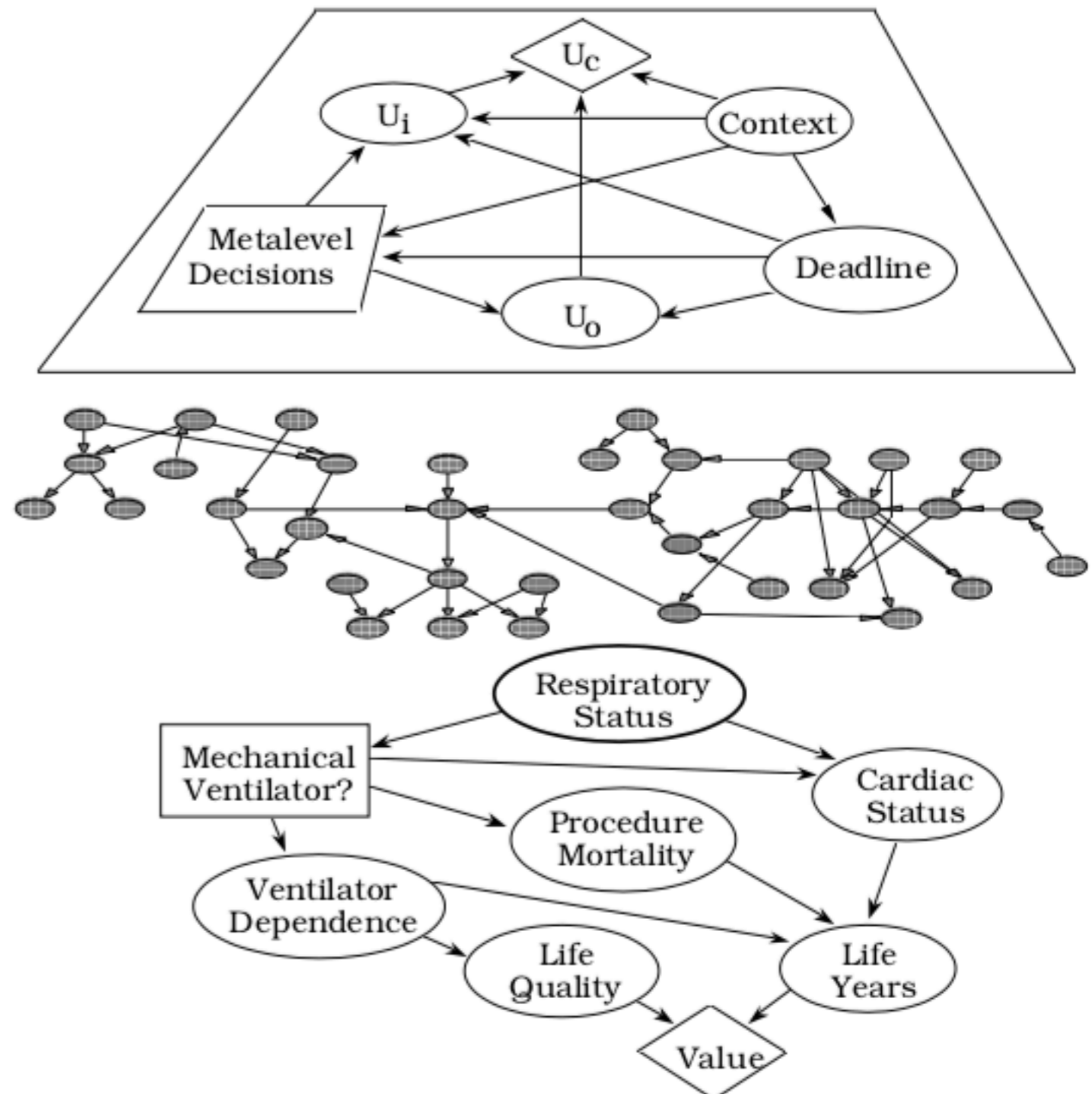

Reinforcement Learning for Speeding up Diagnosis

- Rather than heuristics, use MDP formulation and RL
- State space: set of positive and negative findings
- Action space: ask about a finding, or conclude a diagnosis
- Reward: correct or incorrect (**single**) diagnosis
- Finite horizon imposed by limit on number of questions
- Discount factor encourages short question sequences
- Standard q-learning framework, using double-deep NN strategy
- Magic sauce:
 - Encourage asking questions likely to have positive answers because of sparsity, by *reward shaping*: add extra reward; policy still optimal
 - Identify reduced finding space by *feature rebuilding*.

© Peng, Y.-S., Tang, K.-F., Lin, H.-T., & Chang, E. Y. All rights reserved. This content is excluded from our Creative Commons license. For more information, see <https://ocw.mit.edu/help/faq-fair-use/>

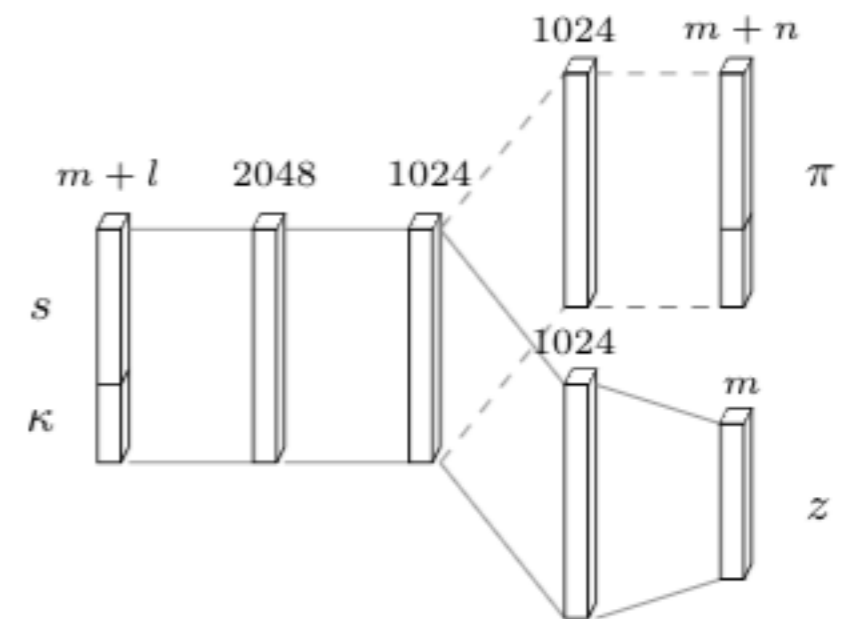

Figure 1: Dual neural network architecture. The upper branch is the policy π of an agent. The lower branch is the feature rebuilding part of sparse features.

MIT OpenCourseWare

<https://ocw.mit.edu>

6.S897 / HST.956 Machine Learning for Healthcare

Spring 2019

For information about citing these materials or our Terms of Use, visit: <https://ocw.mit.edu/terms>