



# 13.811

# Advanced Structural Dynamics and Acoustics

Acoustics  
Lecture 4



# Green's Function

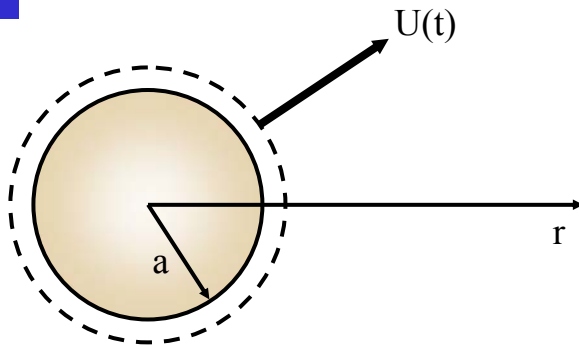

## Helmholts Equation for Green's Function

$$[\nabla^2 + k^2] g_\omega(\mathbf{r}, \mathbf{r}_0) = -\delta(\mathbf{r} - \mathbf{r}_0),$$

$$\psi(r) = -S_\omega \frac{e^{ikr}}{4\pi r}.$$

$$S_\omega = 4\pi a^2 U(\omega)$$

### Green's Function

$$g_\omega(r, 0) = \frac{e^{ikr}}{4\pi r},$$

Source at  $r_0$

$$g_\omega(\mathbf{r}, \mathbf{r}_0) = \frac{e^{ikR}}{4\pi R}, \quad R = |\mathbf{r} - \mathbf{r}_0|.$$

### Proof

$$\int_V -\delta(\mathbf{r} - \mathbf{r}_0) dV = -1$$

$$\int_V k^2 g_\omega(\mathbf{r}, \mathbf{r}_0) dV \rightarrow_{\epsilon \rightarrow 0} 0$$

$$\int_V \nabla^2 g_\omega(\mathbf{r}, \mathbf{r}_0) dV = \int_S \frac{\partial}{\partial R} g_\omega(\mathbf{r}, \mathbf{r}_0) dS$$

$$= \int_S \left[ -\frac{e^{ik\epsilon}}{4\pi\epsilon^2} + \frac{ik e^{ik\epsilon}}{4\pi\epsilon} \right] dS$$

$$= 4\pi\epsilon^2 \left[ -\frac{e^{ik\epsilon}}{4\pi\epsilon^2} + \frac{ik e^{ik\epsilon}}{4\pi\epsilon} \right] \rightarrow_{\epsilon \rightarrow 0} -1$$

Reciprocity

$$g_\omega(\mathbf{r}, \mathbf{r}_0) = g_\omega(\mathbf{r}_0, \mathbf{r}),$$



# Green's Function Spectral Representations

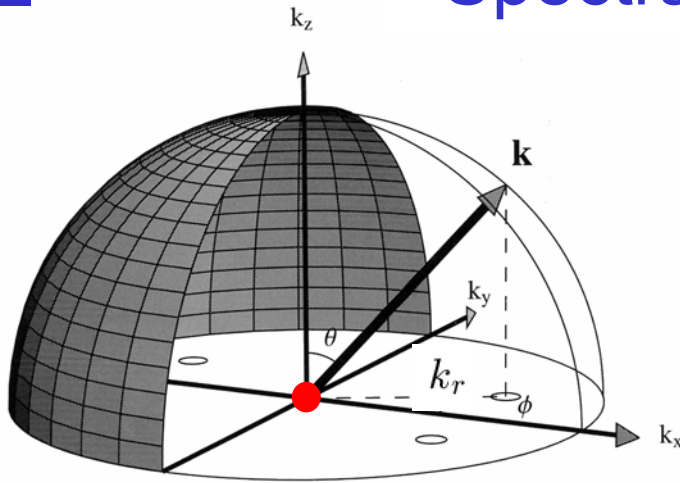

## Cylindrical Coordinates

$$g_{\omega} = \frac{e^{ikR}}{4\pi r} = \frac{i}{4\pi} \int_0^{\infty} \frac{e^{ik_z|z-z_0|}}{k_z} k_r J_0(k_r r) dk_r$$

$$k_r^2 = k_x^2 + k_y^2$$

$$k_z = \begin{cases} \sqrt{k^2 - k_r^2}, & k_r \leq k \\ i\sqrt{k_r^2 - k^2}, & k_r > k \end{cases}$$

$$k_r = k \sin \theta$$

$$k_x = k \sin \theta \cos \phi$$

$$k_y = k \sin \theta \sin \phi$$

## Radiating Spectrum

$$k|z - z_0| \gg 1$$

$$g_{\omega} = \frac{e^{ikR}}{4\pi R} \simeq \frac{i}{4\pi} \int_0^k \frac{e^{ik_z|z-z_0|}}{k_z} k_r J_0(k_r r) dk_r$$

$$k_r = k \sin \theta ; \quad dk_r = k \cos \theta d\theta = k_z d\theta$$

## Normalized Pressure – $p(1m) = 1$

$$p_{\omega} = \frac{e^{ikR}}{R} = i \int_0^{\frac{\pi}{2}} e^{ik|z-z_0| \cos \theta} k_r J_0(k_r r) d\theta$$

## Far Field Directivity Function

$$kR \gg 1$$

$$p_{\omega}(R, \theta) = \boxed{D(\theta)} \frac{e^{ikR}}{R} \simeq i \int_0^{\frac{\pi}{2}} \boxed{D(\theta)} [e^{ik|z-z_0| \cos \theta} k_r J_0(k_r r)] d\theta$$

## Simple Point Source

$$D(\theta) = 1$$



# Green's Function Spectral Representations

Ewald Sphere

$D(\theta, \phi)$

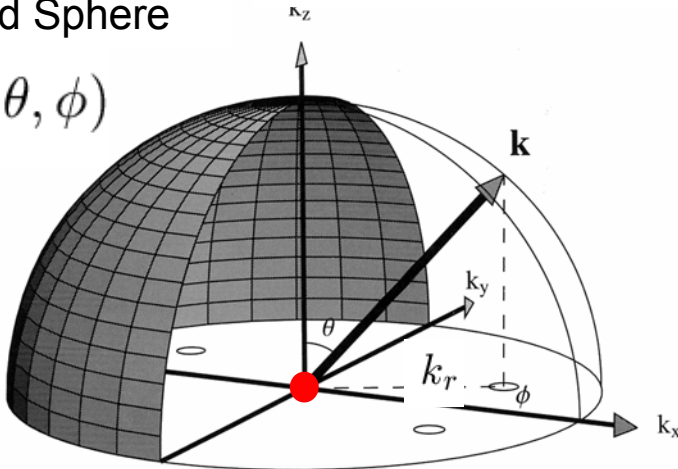

Cartesian Coordinates

$$g_\omega = \frac{e^{ikR}}{4\pi R} = \frac{i}{8\pi^2} \int_{-\infty}^{\infty} \int_{-\infty}^{\infty} \frac{e^{ik_z|z-z_0|}}{k_z} e^{ik_x x} e^{ik_y y} dk_x dk_y$$

$$k_r^2 = k_x^2 + k_y^2$$

$$k_z = \begin{cases} \sqrt{k^2 - k_r^2}, & k_r \leq k \\ i\sqrt{k_r^2 - k^2}, & k_r > k. \end{cases}$$

$$k_r = k \sin \theta$$

$$k_x = k \sin \theta \cos \phi$$

$$k_y = k \sin \theta \sin \phi$$

Normalized Pressure –  $p(1m) = 1$

$$p_\omega = 4\pi g_\omega = \frac{e^{ikR}}{R} = \frac{i}{2\pi} \int_{-\infty}^{\infty} \int_{-\infty}^{\infty} \frac{e^{ik_z|z-z_0|}}{k_z} e^{ik_x x} e^{ik_y y} dk_x dk_y$$

Far Field Directivity Function

$$kR \gg 1$$

$$p_\omega = \boxed{D(\theta, \phi)} \frac{e^{ikR}}{R} \simeq \frac{i}{2\pi} \int_{-\infty}^{\infty} \int_{-\infty}^{\infty} \boxed{D(\theta, \phi)} \frac{e^{ik_z|z-z_0|}}{k_z} e^{ik_x x} e^{ik_y y} dk_x dk_y$$

Simple Point Source

$$D(\theta, \phi) = 1$$



# Directivity Function Lloyd-Mirror Pattern

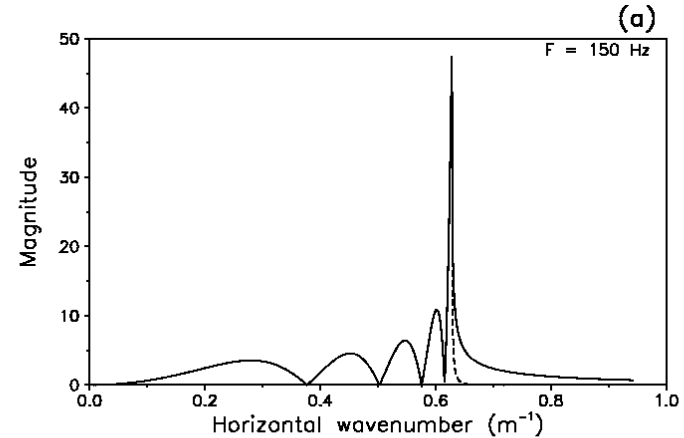
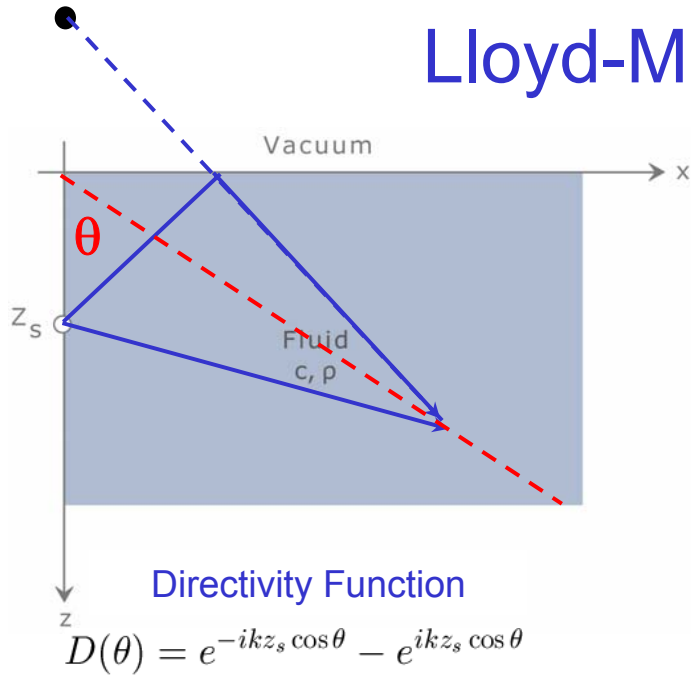

## Directivity Maxima and Minima

$$2k_z z_s = (2n + 1)\pi$$

$$\Leftrightarrow k_z = \frac{(2n + 1)\pi}{2z_s}$$

$$\Leftrightarrow \cos \theta_{\max} = \frac{(2n + 1)\pi}{2kz_s}$$

$$\cos \theta_{\min} = \frac{2n\pi}{2kz_s}$$

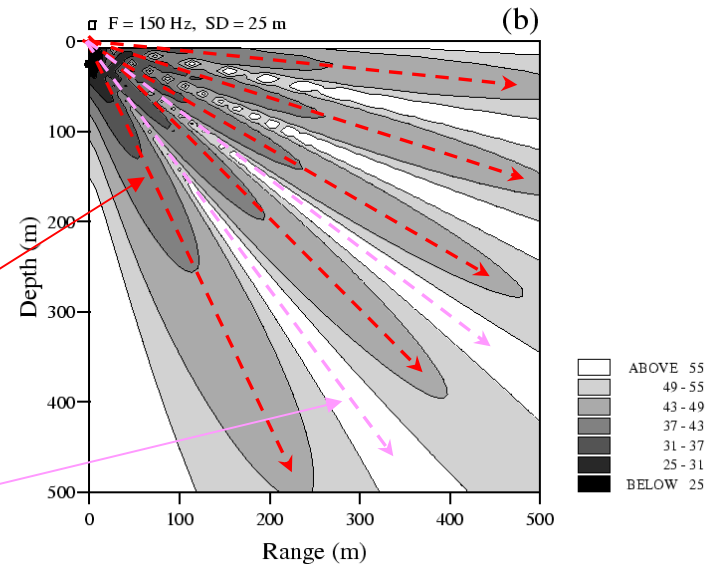



# Directivity Function Rectangular Baffled Piston

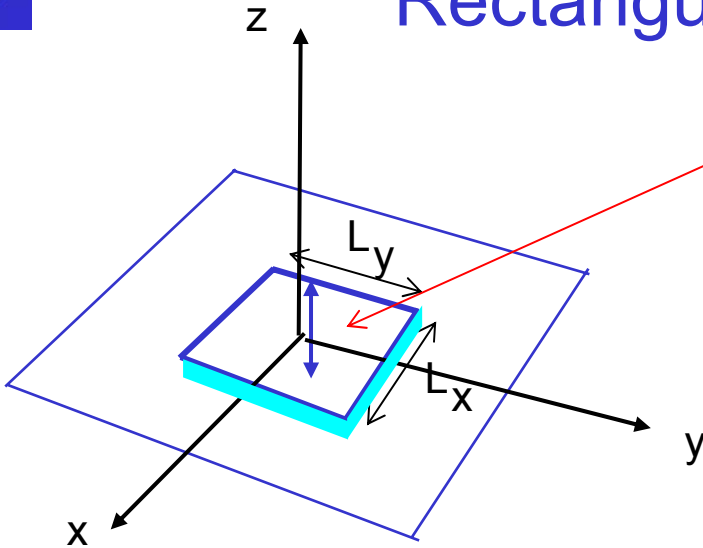

$$\dot{w}_\omega(x, y, 0) = \Pi(x/L_x)\Pi(y/L_y) = \begin{cases} 1 & |x| < L_x/2, |y| < L_y/2 \\ 0 & \text{otherwise} \end{cases}$$

Fourier Transform

$$\int_{-\infty}^{\infty} \Pi(x/L) e^{-i(k_x x)} dx = L \text{sinc}(k_x L/2)$$

$$\begin{aligned} \dot{w}_\omega(k_x, k_y; 0) &= \int_{-\infty}^{\infty} \int_{-\infty}^{\infty} \dot{w}_\omega(x, y, 0) e^{-i(k_x x + k_y y)} dx dy \\ &= L_x L_y \text{sinc}\left(\frac{k_x L_x}{2}\right) \text{sinc}\left(\frac{k_y L_y}{2}\right) \end{aligned}$$

Radiated Field

$$\psi_\omega(k_x, k_y; z) = A(k_x, k_y) e^{i k_z z}$$

$$\dot{w}_\omega(k_x, k_y; z) = -i\omega \frac{\partial \psi_\omega(k_x, k_y; z)}{\partial z} = \omega k_z A(k_x, k_y) e^{i k_z z}$$

$$A(k_x, k_y) = \frac{L_x L_y}{k_z \omega} \text{sinc}\left(\frac{k_x L_x}{2}\right) \text{sinc}\left(\frac{k_y L_y}{2}\right)$$

$$p_\omega(x, y, z) = \rho \omega^2 \psi_\omega(x, y, z)$$

$$= \frac{\rho \omega L_x L_y}{4\pi^2} \int_{-\infty}^{\infty} \int_{-\infty}^{\infty} \text{sinc}\left(\frac{k_x L_x}{2}\right) \text{sinc}\left(\frac{k_y L_y}{2}\right) \frac{e^{i k_z |z - z_0|}}{k_z} e^{i k_x x} e^{i k_y y} dk_x dk_y$$

$\text{sinc}(k_x L/2)$

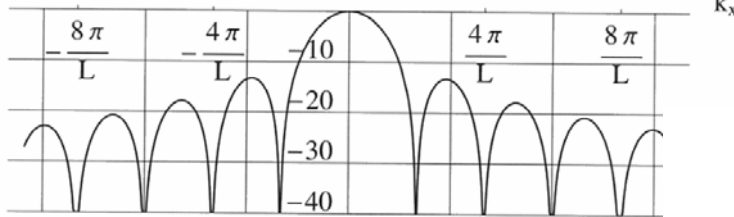

Directivity Function - Definition

$$p_\omega = D(\theta, \phi) \frac{e^{i k R}}{R} \simeq \frac{i}{2\pi} \int_{-\infty}^{\infty} \int_{-\infty}^{\infty} D(\theta, \phi) \frac{e^{i k_z |z - z_0|}}{k_z} e^{i k_x x} e^{i k_y y} dk_x dk_y$$

$$D(\theta, \phi) = -\frac{i \rho \omega L_x L_y}{2\pi} \text{sinc}\left(\frac{k_x L_x}{2}\right) \text{sinc}\left(\frac{k_y L_y}{2}\right)$$



# Ewald Sphere Construction Square Baffled Piston

## Directivity Function

$$D(\theta, \phi) = -\frac{i\rho\omega L_x L_y}{2\pi} \text{sinc}\left(\frac{k_x L_x}{2}\right) \text{sinc}\left(\frac{k_y L_y}{2}\right)$$

$$L_y = L_x = L$$

$$f = \omega/2\pi = kc/2\pi = 4c/L$$

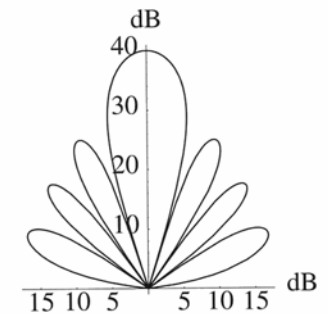
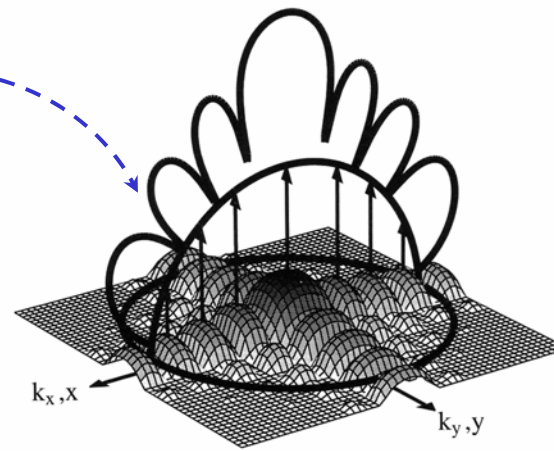
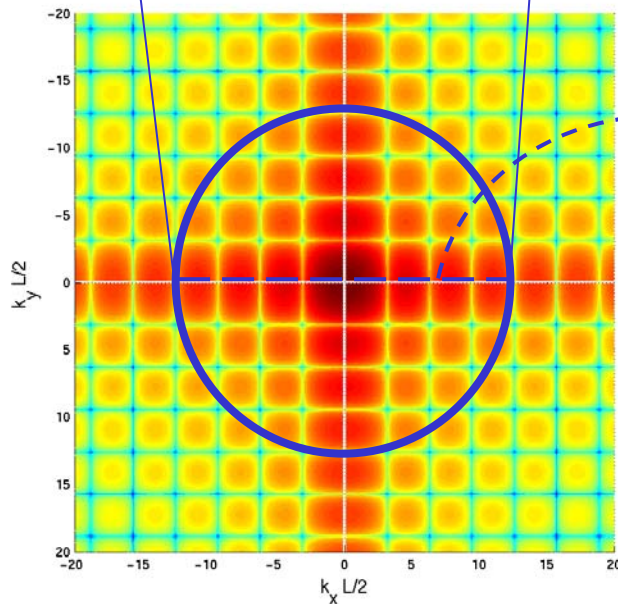
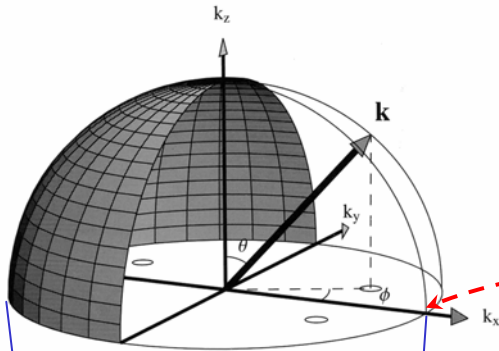



# Ewald Sphere Construction Square Baffled Piston

## Directivity Function

$$D(\theta, \phi) = -\frac{i\rho\omega L_x L_y}{2\pi} \text{sinc}\left(\frac{k_x L_x}{2}\right) \text{sinc}\left(\frac{k_y L_y}{2}\right)$$

$$L_y = L_x = L$$

$$f = \omega/2\pi = kc/2\pi = 20c/L$$

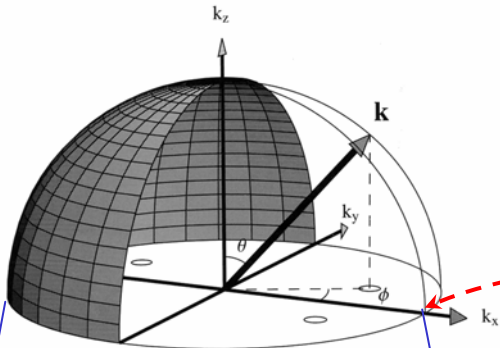

$$\text{sinc}\left(\frac{k_x L_x}{2}\right) \text{sinc}\left(\frac{k_y L_y}{2}\right)$$

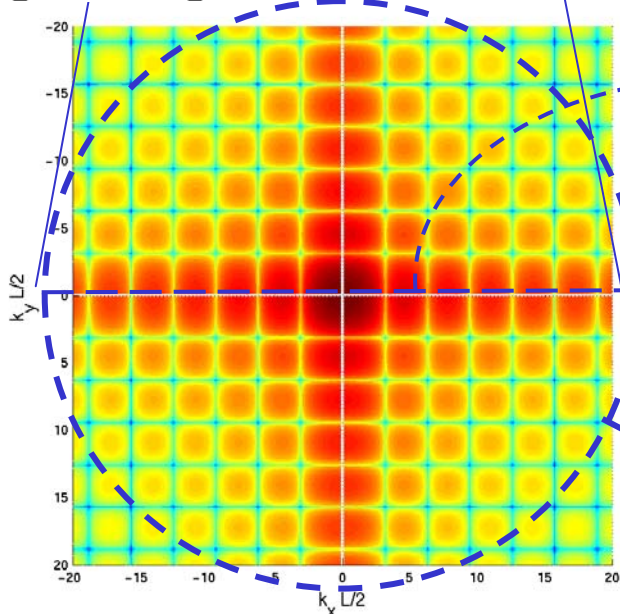

$$k = 40\pi/L$$

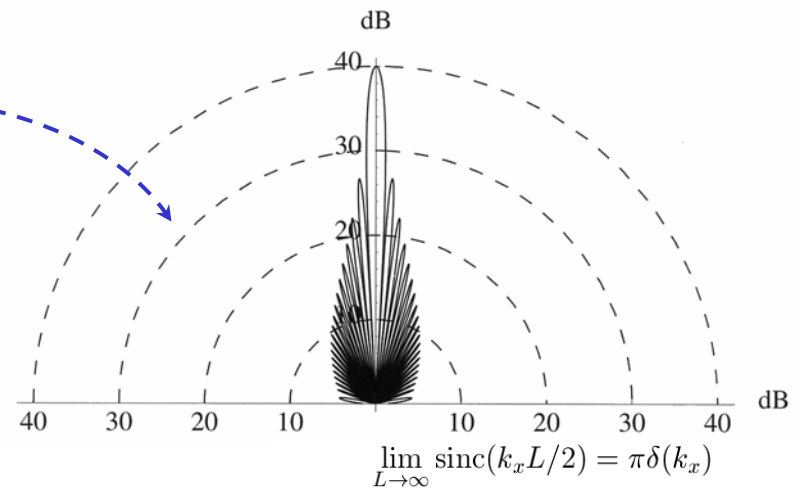

$$\lim_{L \rightarrow \infty} \text{sinc}(k_x L/2) = \pi \delta(k_x)$$

$$\lim_{L_x, L_y \rightarrow \infty} D(\theta, \phi) = -\frac{i\pi\rho\omega \delta(k_x) \delta(k_y)}{2}$$





# Square Baffled Plate with Traveling Wave

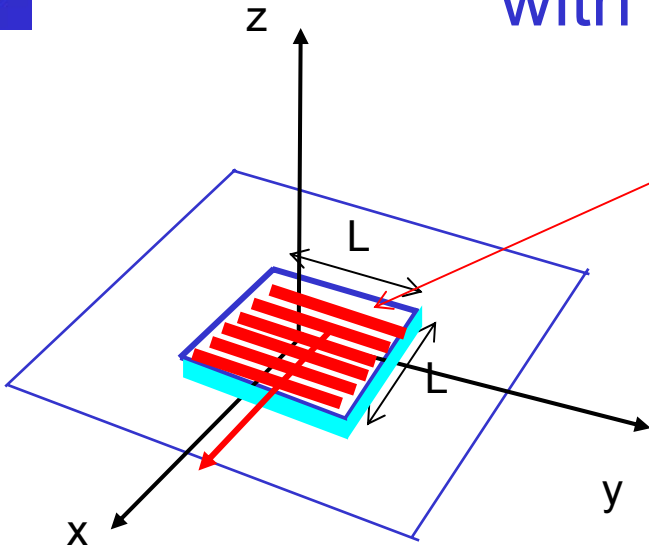

$$\dot{w}_\omega(x, y, 0) = \begin{cases} e^{ik_{x0}x} & |x| < L/2, |y| < L/2 \\ 0 & \text{otherwise} \end{cases}$$

$$\dot{w}_\omega(x, y, 0) = e^{ik_{x0}x} \Pi(x/L) \Pi(y/L)$$

$$\Pi(x/L) = \begin{cases} 1 & |x| < L/2 \\ 0 & |x| > L/2 \end{cases}$$

$$\begin{aligned} \dot{w}_\omega(k_x, k_y; 0) &= \int_{-\infty}^{\infty} \int_{-\infty}^{\infty} \dot{w}_\omega(x, y, 0) e^{-i(k_x x + k_y y)} dx dy \\ &= \int_{-\infty}^{\infty} \Pi(x/L) e^{ik_{x0}x} e^{-i(k_x x)} dx \int_{-\infty}^{\infty} \Pi(y/L) e^{-i(k_y y)} dy \\ &= L^2 [\text{sinc}(k_x L/2) * \delta(k_x - k_{x0})] \text{sinc}(k_y L/2) \\ &= L^2 \text{sinc}((k_x - k_{x0})L/2) \text{sinc}(k_y L/2) \end{aligned}$$

$$\int_{-\infty}^{\infty} \Pi(x/L) e^{-i(k_x x)} dx = L \text{sinc}(k_x L/2)$$

$$\int_{-\infty}^{\infty} e^{ik_{x0}x} e^{-ik_x x} dx = 2\pi \delta(k_x - k_{x0})$$

$$\int_{-\infty}^{\infty} f(x)g(x)e^{-ik_x x} dx = \frac{1}{2\pi} f(k_x) * g(k_x)$$

Directivity Function - Definition

$$\begin{aligned} p_\omega(x, y, z) &= \rho \omega^2 \psi_\omega(x, y, z) \\ &= \frac{\rho \omega L^2}{4\pi^2} \int_{-\infty}^{\infty} \int_{-\infty}^{\infty} \text{sinc}\left(\frac{(k_x - k_{x0})L}{2}\right) \text{sinc}\left(\frac{k_y L}{2}\right) \frac{e^{ik_z |z - z_0|}}{k_z} e^{ik_x x} e^{ik_y y} dk_x dk_y \end{aligned}$$

$$p_\omega = D(\theta, \phi) \frac{e^{ikR}}{R} \simeq \frac{i}{2\pi} \int_{-\infty}^{\infty} \int_{-\infty}^{\infty} D(\theta, \phi) \frac{e^{ik_z |z - z_0|}}{k_z} e^{ik_x x} e^{ik_y y} dk_x dk_y$$

$$D(\theta, \phi) = -\frac{i\rho\omega L^2}{2\pi} \text{sinc}\left(\frac{(k_x - k_{x0})L}{2}\right) \text{sinc}\left(\frac{k_y L}{2}\right)$$



# Square Baffled Plate with Traveling Wave – $\theta_0 = 30^\circ$

## Directivity Function

$$D(\theta, \phi) = -\frac{i\rho\omega L^2}{2\pi} \text{sinc}\left(\frac{(k_x - k_{x0})L}{2}\right) \text{sinc}\left(\frac{k_y L}{2}\right)$$

$$\text{sinc}(k_x - k_{x0})L/2 = \text{sinc}(kL(\sin\theta \cos\phi - \sin\theta_0 \cos\phi_0)/2)$$

$$f = \omega/2\pi = kc/2\pi = 15c/\pi L$$

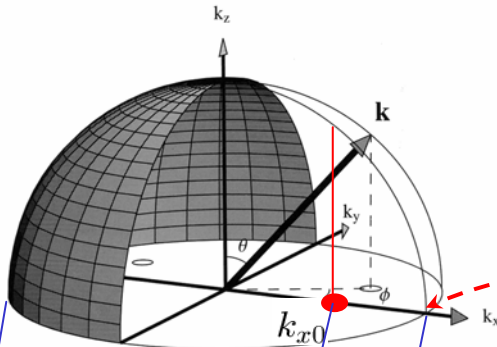

$$\text{sinc}\left(\frac{(k_x - k_{x0})L}{2}\right) \text{sinc}\left(\frac{k_y L}{2}\right)$$

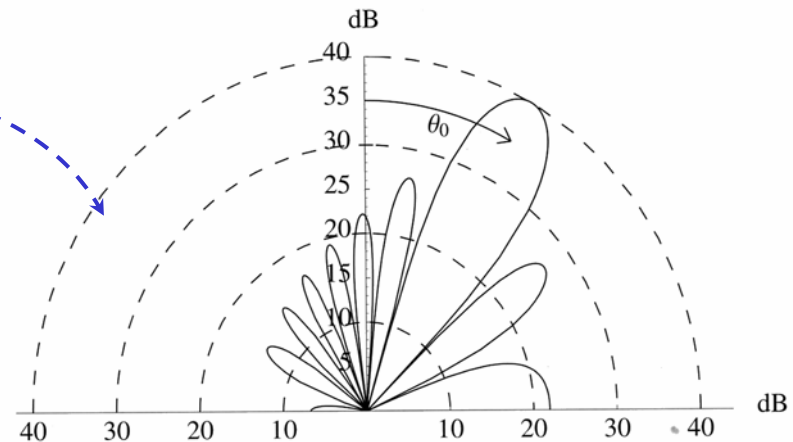
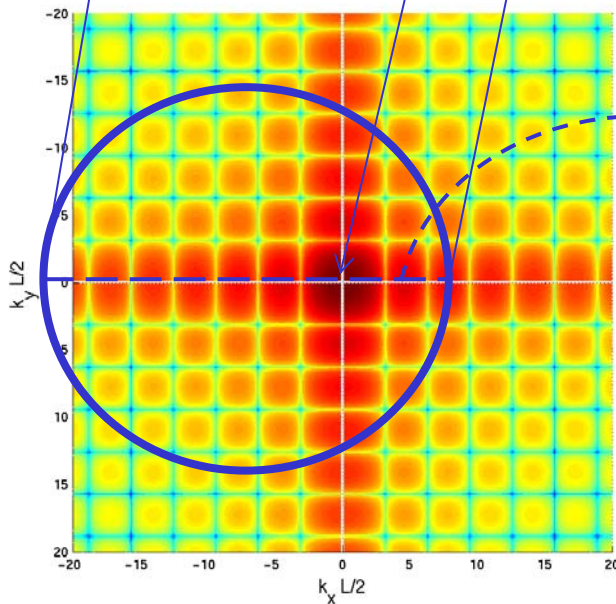



# Square Baffled Plate with Traveling Wave – $\theta_0 = 90^\circ$

## Directivity Function

$$D(\theta, \phi) = -\frac{i\rho\omega L^2}{2\pi} \operatorname{sinc}\left(\frac{(k_x - k_{x0})L}{2}\right) \operatorname{sinc}\left(\frac{k_y L}{2}\right)$$

$$\operatorname{sinc}(k_x - k_{x0})L/2 = \operatorname{sinc}(kL(\sin\theta \cos\phi - \sin\theta_0 \cos\phi_0)/2)$$

$$f = \omega/2\pi = kc/2\pi = 15c/\pi L$$

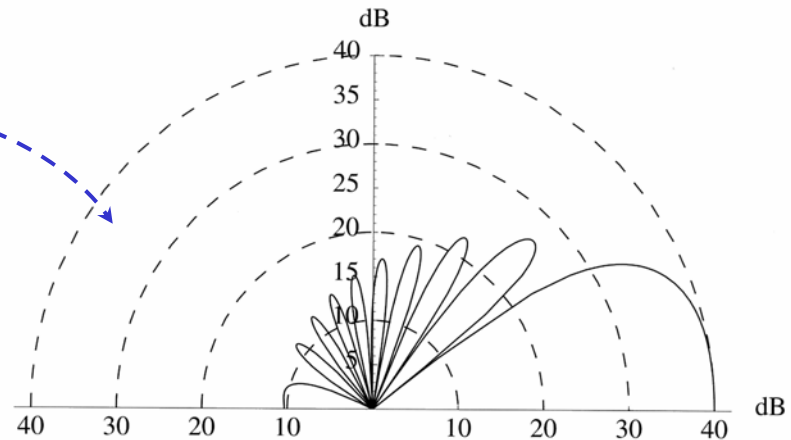
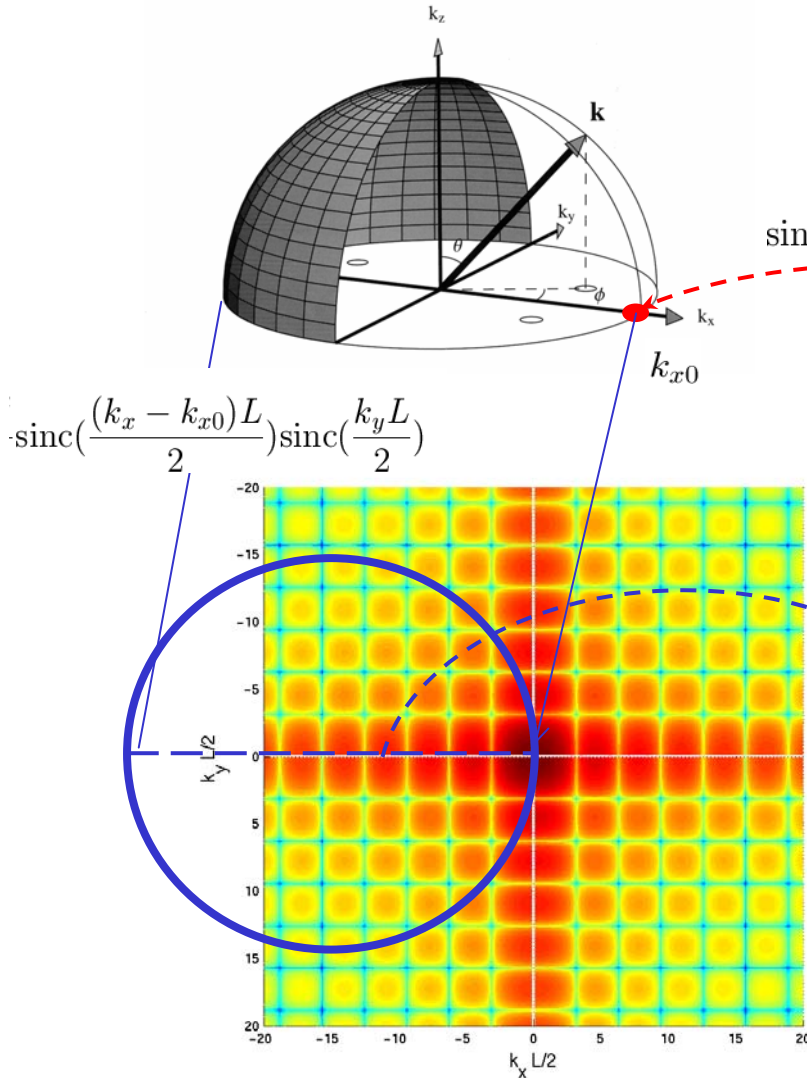



# Directivity Function Circular Baffled Piston

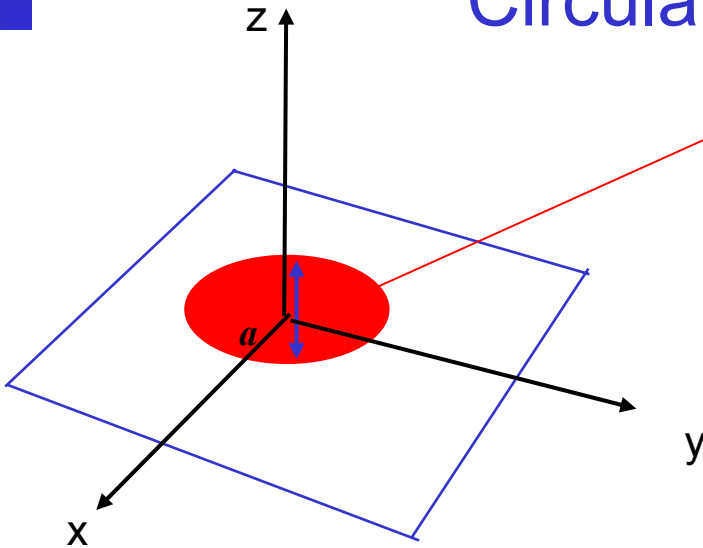

$$\dot{w}_\omega(r, \phi, 0) = \dot{w}_\omega(r, 0) = \begin{cases} 1 & r \leq a, \\ 0 & r > a \end{cases}$$

## Hankel Transform

$$\begin{aligned} \dot{w}(k_r, 0) &= \int_0^\infty \dot{w}(r, 0) r J_0(k_r r) dr \\ &= \int_0^a J_0(k_r r) r dr = \frac{a}{k_r} J_1(k_r a) \end{aligned}$$

$$\dot{w}(k_r, z) = \dot{w}(k_r, 0) e^{ik_z z}$$

$$\left. \begin{aligned} \dot{w}(k_r, z) &= \omega k_z \psi_\omega(k_r, z) \\ p_\omega(k_r, z) &= \rho \omega^2 \psi_\omega(k_r, z) \end{aligned} \right\} \Rightarrow p_\omega(k_r, z) = \frac{\rho \omega}{k_z} \dot{w}(k_r, z)$$

## Radiated Pressure Field

$$p_\omega(r, z) = \rho \omega \int_0^a \frac{a}{k_r} J_1(k_r a) \frac{e^{ik_z z}}{k_z} J_0(k_r r) k_r dk_r$$

## Directivity Function - Definition

$$p_\omega(r, z) = D(\theta) \frac{e^{ikR}}{R} \simeq i \int_0^k D(\theta) \frac{e^{ik_z |z-z_0|}}{k_z} k_r J_0(k_r r) dk_r$$

$$\begin{aligned} D(\theta, \phi) = D(\theta) &= -i \rho \omega a^2 \frac{J_1(k_r a)}{k_r a} \\ &= -\frac{i \rho \omega S_\omega J_1(k_r a)}{\pi k_r a} \end{aligned}$$

Source Strength - Volume Injection  $S_\omega = \pi a^2$



# Ewald Sphere Construction Circular Baffled Piston

Directivity Function

$$D(\theta, \phi) = D(\theta) = -i\rho\omega a^2 \frac{J_1(k_r a)}{k_r a}$$

$$f = \omega/2\pi = kc/2\pi = 5c/a\pi \quad (ka = 10)$$

