

Charge Separation Part 2: Diode Under Illumination (*a.k.a.* IV Curve Lecture)

Lecture 6 – 9/27/2011

MIT Fundamentals of Photovoltaics
2.626/2.627 – Fall 2011

Prof. Tonio Buonassisi

Kind Reminder

- 2.626 is the graduate version of the class.
- 2.627 is the undergrad version of the class.

Please ensure you're signed up for the right version!

2.626/2.627: Roadmap

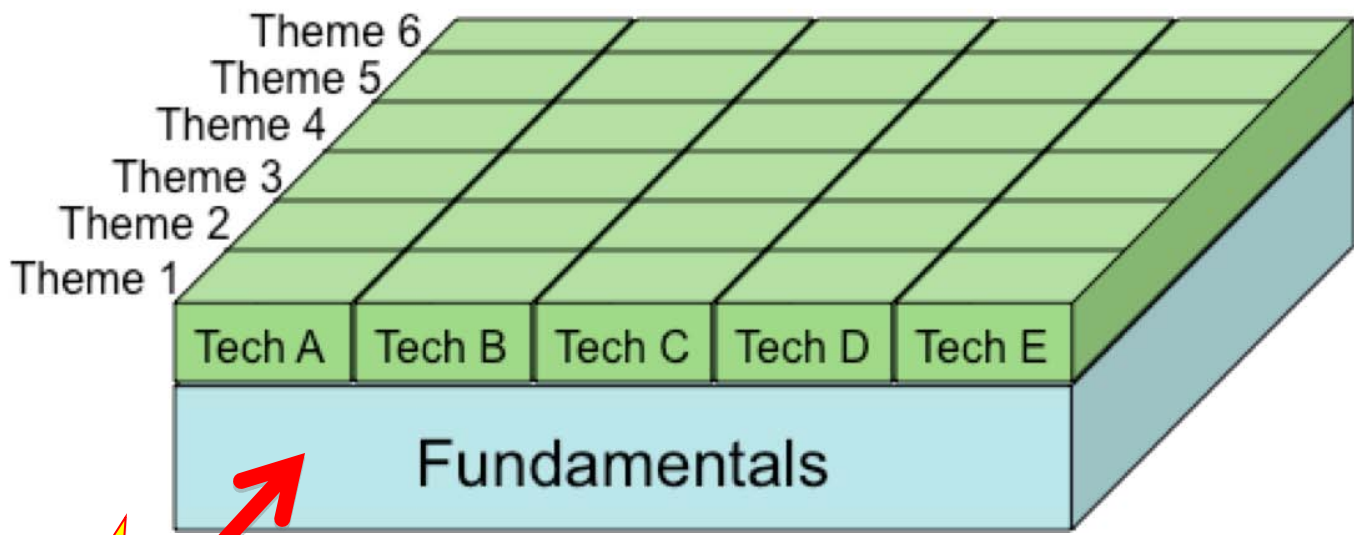

2.626/2.627: Fundamentals

Every photovoltaic device must obey:

$$\text{Conversion Efficiency } (\eta) \equiv \frac{\text{Output Energy}}{\text{Input Energy}}$$

For most solar cells, this breaks down into:

Inputs

Outputs

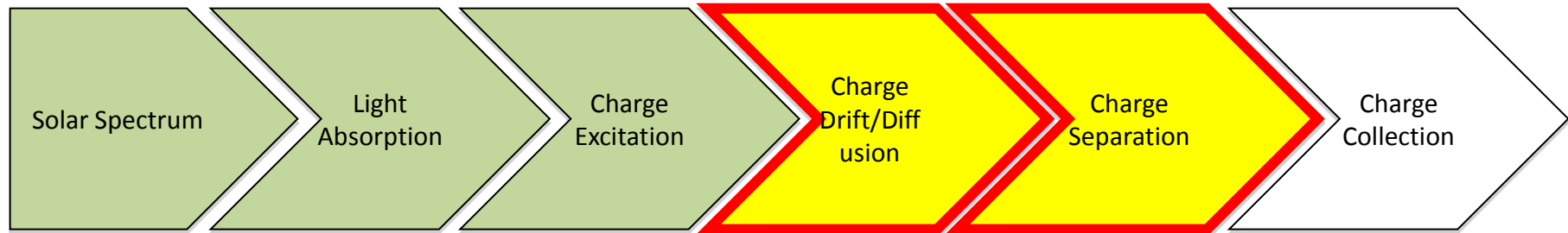

$$\eta_{\text{total}} = \eta_{\text{absorption}} \times \eta_{\text{excitation}} \times \eta_{\text{drift/diffusion}} \times \eta_{\text{separation}} \times \eta_{\text{collection}}$$

Liebig's Law of the Minimum

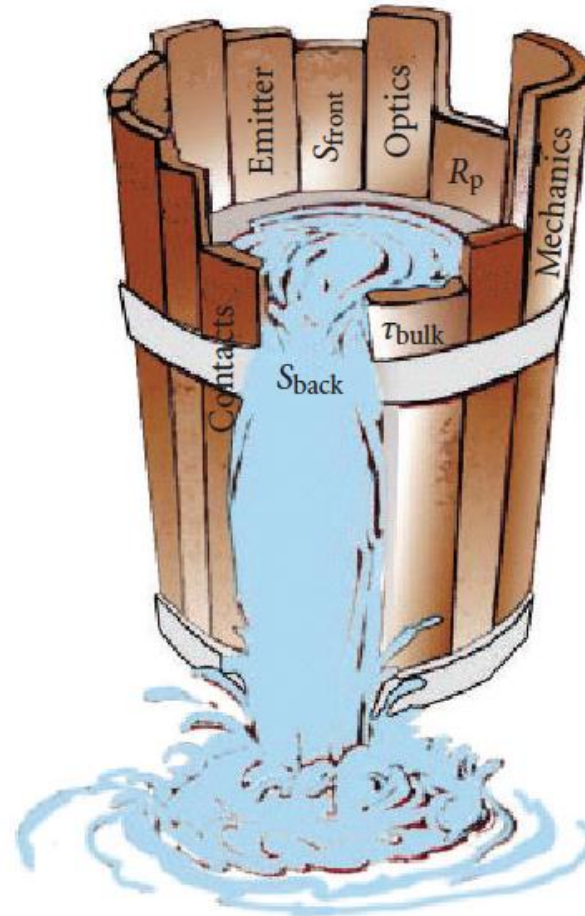

S. Glunz, *Advances in Optoelectronics* 97370 (2007)

Image by S. W. Glunz. License: CC-BY. Source: "[High-Efficiency Crystalline Silicon Solar Cells](#)." *Advances in OptoElectronics* (2007).

$$\eta_{\text{total}} = \eta_{\text{absorption}} \times \eta_{\text{excitation}} \times \eta_{\text{drift/diffusion}} \times \eta_{\text{separation}} \times \eta_{\text{collection}}$$

Another system in which all parts must be optimized

Leaf Photosynthetic Efficiency

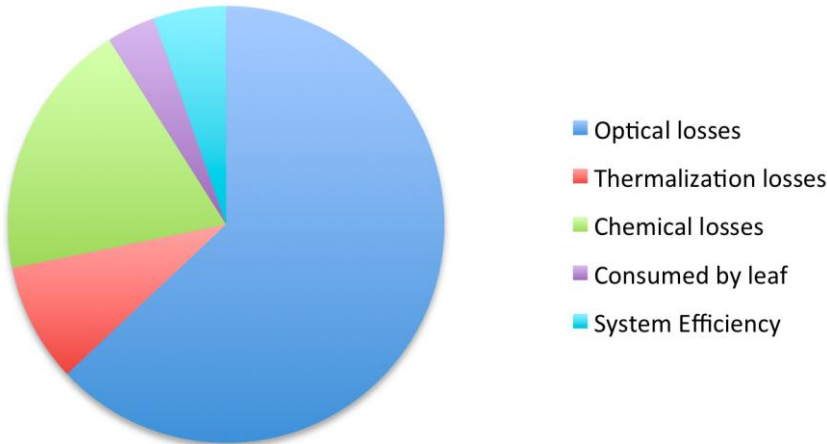

<http://hyperphysics.phy-astr.gsu.edu/hbase/Biology/ligabs.html>

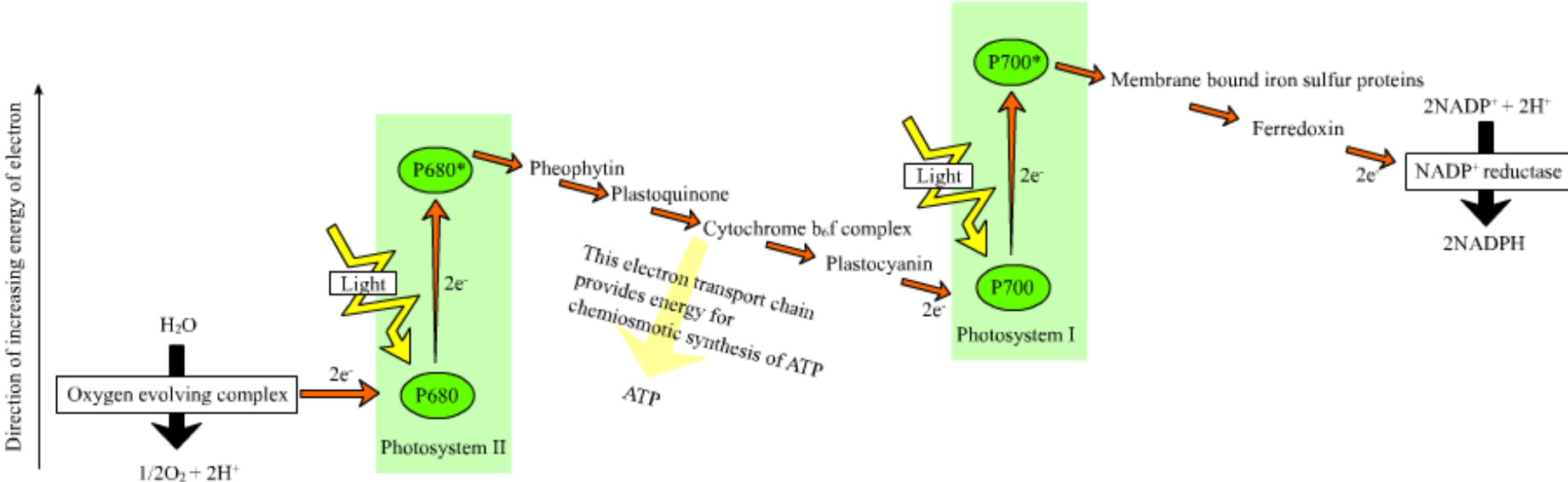

http://en.wikipedia.org/wiki/Photosynthetic_efficiency

Learning Objectives: Illuminated Solar Cell

1. **Diode in the Dark: Construct energy band diagram of pn -junction.**
2. **Diode under illumination: Construct energy band diagram. Denote drift, diffusion, and illumination currents.**
3. In class exercise: Measure illuminated IV curves.
4. Define parameters that determine solar cell efficiency:
 - Built-in voltage (V_{bi})
 - Bias voltage (V_{bias})
 - Open-circuit voltage (V_{oc})
 - Short-circuit current (J_{sc})
 - Saturation (leakage) current (J_o)
 - Maximum power point (MPP)
 - Fill factor (FF)

Key Concept:

The current-voltage response of an ideal pn-junction can be described by the “Ideal diode equation”. We plot the ideal diode equation for dark and illuminated cases. Forward, reverse, and zero bias conditions are represented on the same curves.

Exercise: pn-junctions under bias

- For a pn-junction under different bias conditions,
 - Draw I-V curves for the solar cell.
 - With a dot, denote the “operating point” for each bias condition.
 - With arrows, denote the magnitude of the the saturation current (I_o).

Exercise: pn-junctions under bias

- For a pn-junction under different bias conditions,
 - Draw equivalent circuit diagrams for each bias condition.
 - Draw the external bias (V_A).
 - Draw the relative width of the space-charge region.
 - Draw an arrow for the electric field (ξ). Relative magnitudes of the arrows correspond to relative magnitudes of the electric fields.
 - Draw the direction of current flow (I).
 - Draw the direction of electron flow.

pn-junction, in the dark

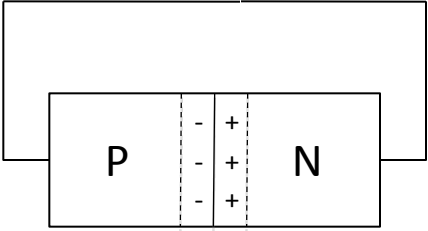
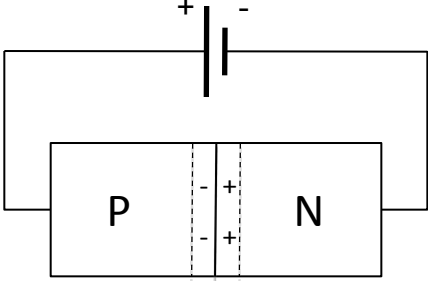
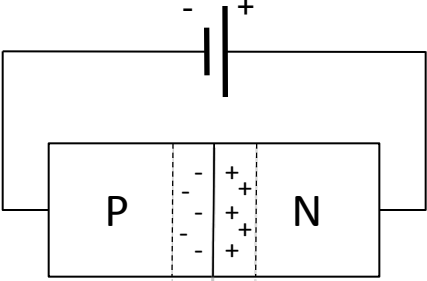
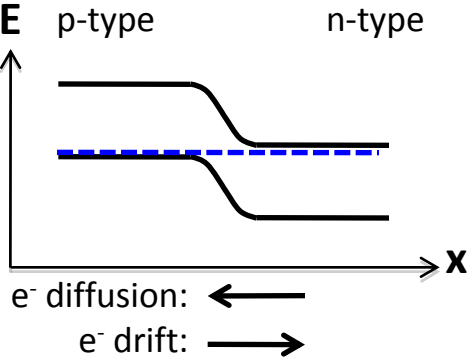
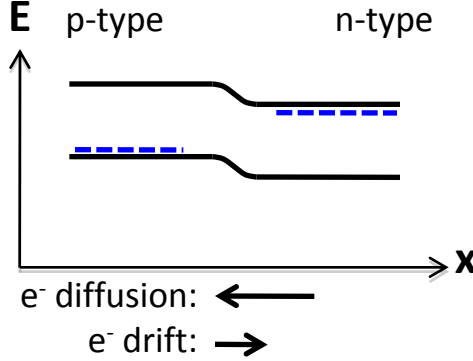
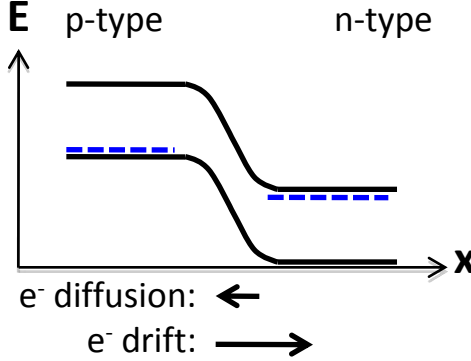
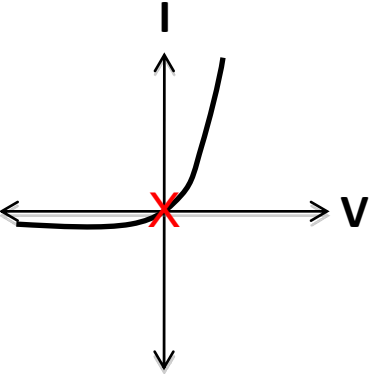
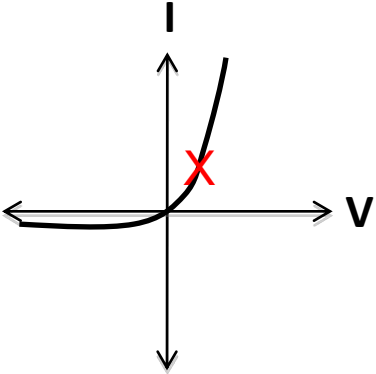
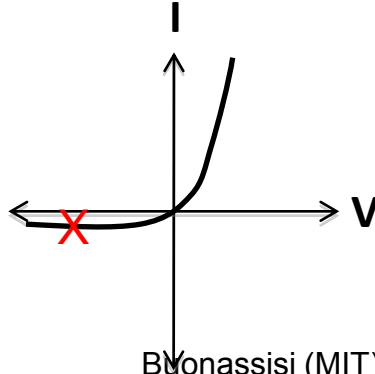
	No Bias	Forward Bias	Reverse Bias
Model Circuit			
Band Diagram	 <p>E p-type n-type</p> <p>x</p> <p>e^- diffusion: \leftarrow</p> <p>e^- drift: \rightarrow</p>	 <p>E p-type n-type</p> <p>x</p> <p>e^- diffusion: \leftarrow</p> <p>e^- drift: \rightarrow</p>	 <p>E p-type n-type</p> <p>x</p> <p>e^- diffusion: \leftarrow</p> <p>e^- drift: \rightarrow</p>
I-V Curve	 <p>I</p> <p>V</p>	 <p>I</p> <p>V</p>	 <p>I</p> <p>V</p>

pn-junction, under illumination

	No Bias	Forward Bias	Reverse Bias
Model Circuit			
Band Diagram	<p> E p-type n-type x e^- diffusion: ← e^- drift: → ill. current: → </p>	<p> E p-type n-type x e^- diffusion: ← e^- drift: → ill. current: → </p>	<p> E p-type n-type x e^- diffusion: ← e^- drift: → ill. current: → </p>
I-V Curve			

Ideal Diode Equation

Following the derivation in Green (Ch. 4, Eq. 4.43):

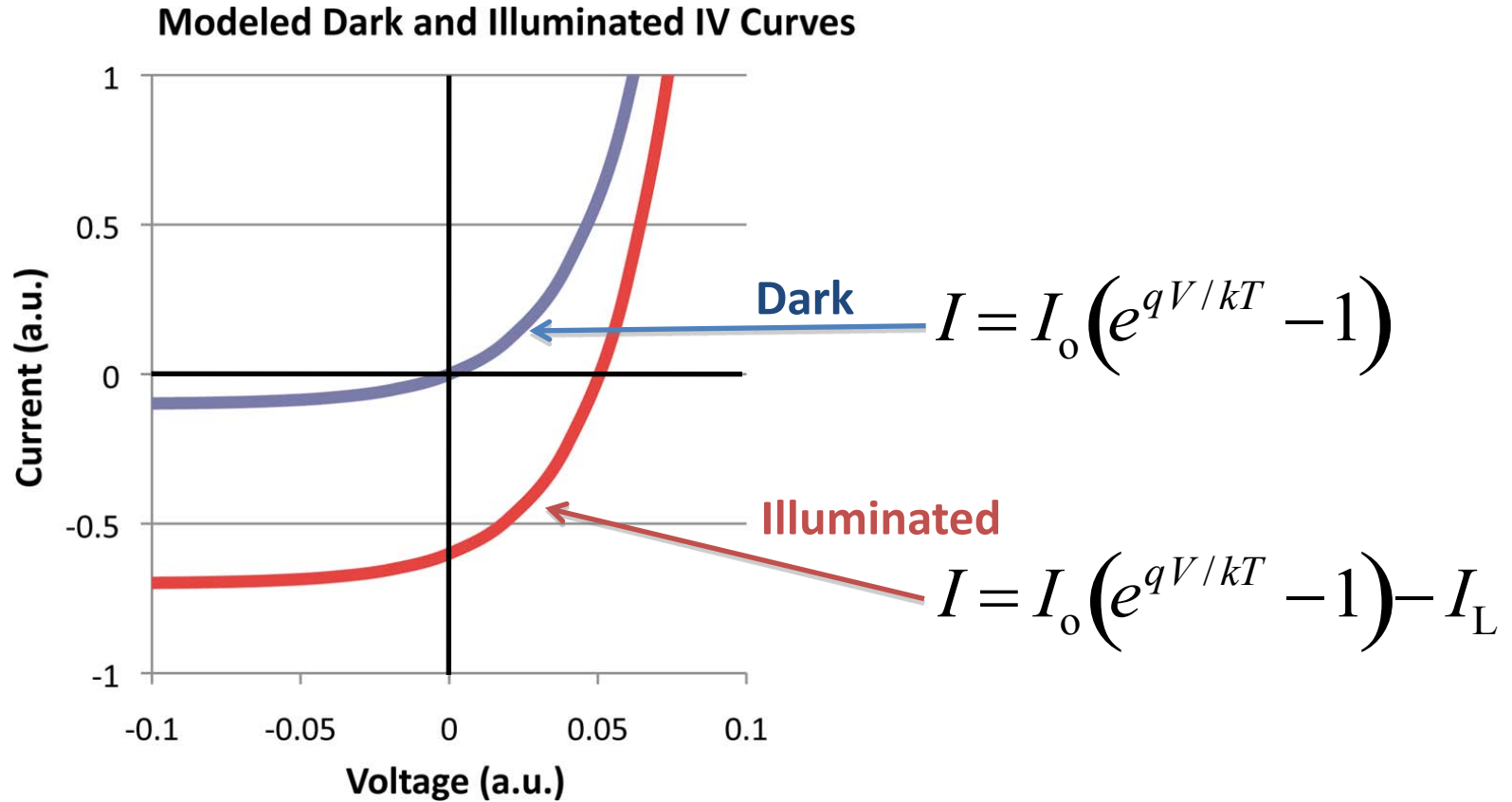

Curves designed using ideal diode equation, with $I_o = 0.1$ (a.u.), and $I_L = 0.6$ (a.u.).

Graphical Representation of Variables

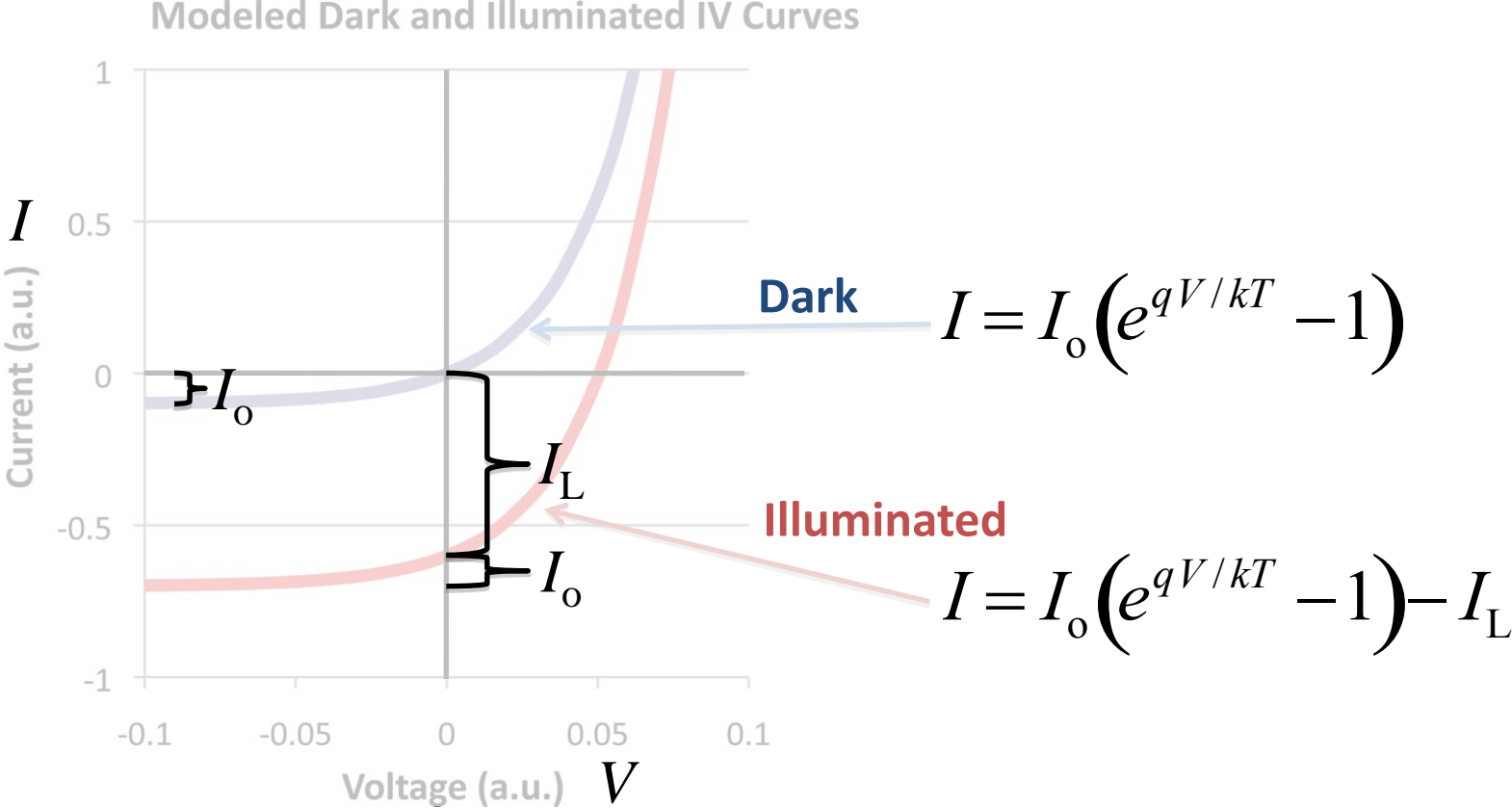

Curves designed using ideal diode equation, with $I_0 = 0.1$ (a.u.), and $I_L = 0.6$ (a.u.).

Graphical Representation of Bias Conditions

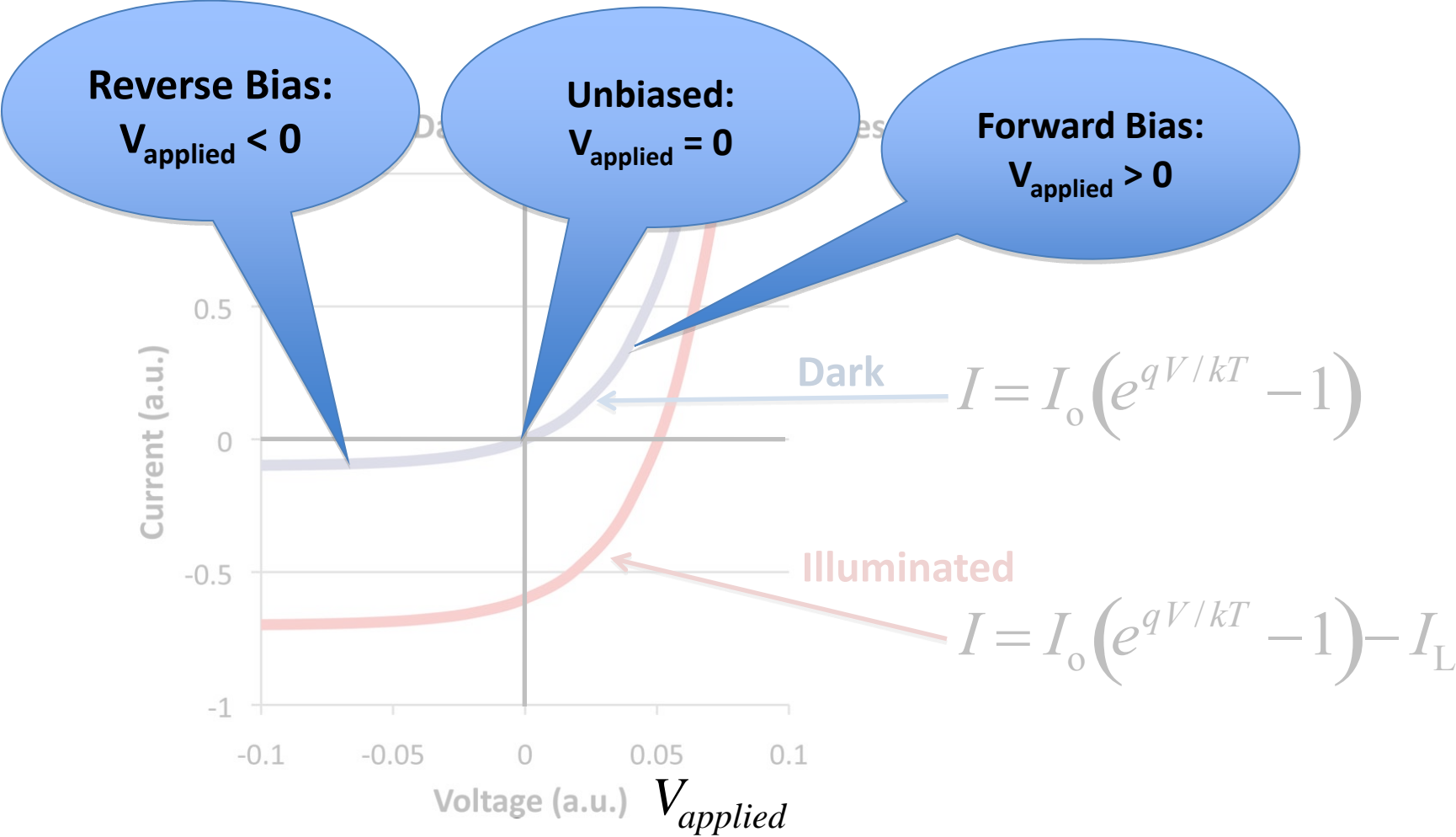

Curves designed using ideal diode equation, with $I_0 = 0.1$ (a.u.), and $I_L = 0.6$ (a.u.).

Readings are strongly encouraged

- Green, Chapter 4
- <http://www.pveducation.org/pvcdrom/>,
Chapters 3 & 4.

Learning Objectives: Illuminated Solar Cell

1. Diode in the Dark: Construct energy band diagram of pn -junction.
2. Diode under illumination: Construct energy band diagram. Denote drift, diffusion, and illumination currents.
- 3. In class exercise: Measure illuminated IV curves.**
4. Define parameters that determine solar cell efficiency:
 - Built-in voltage (V_{bi})
 - Bias voltage (V_{bias})
 - Open-circuit voltage (V_{oc})
 - Short-circuit current (J_{sc})
 - Saturation (leakage) current (J_o)
 - Maximum power point (MPP)
 - Fill factor (FF)

Hands-On: Measure Solar Cell IV Curves

Overall Circuit Layout

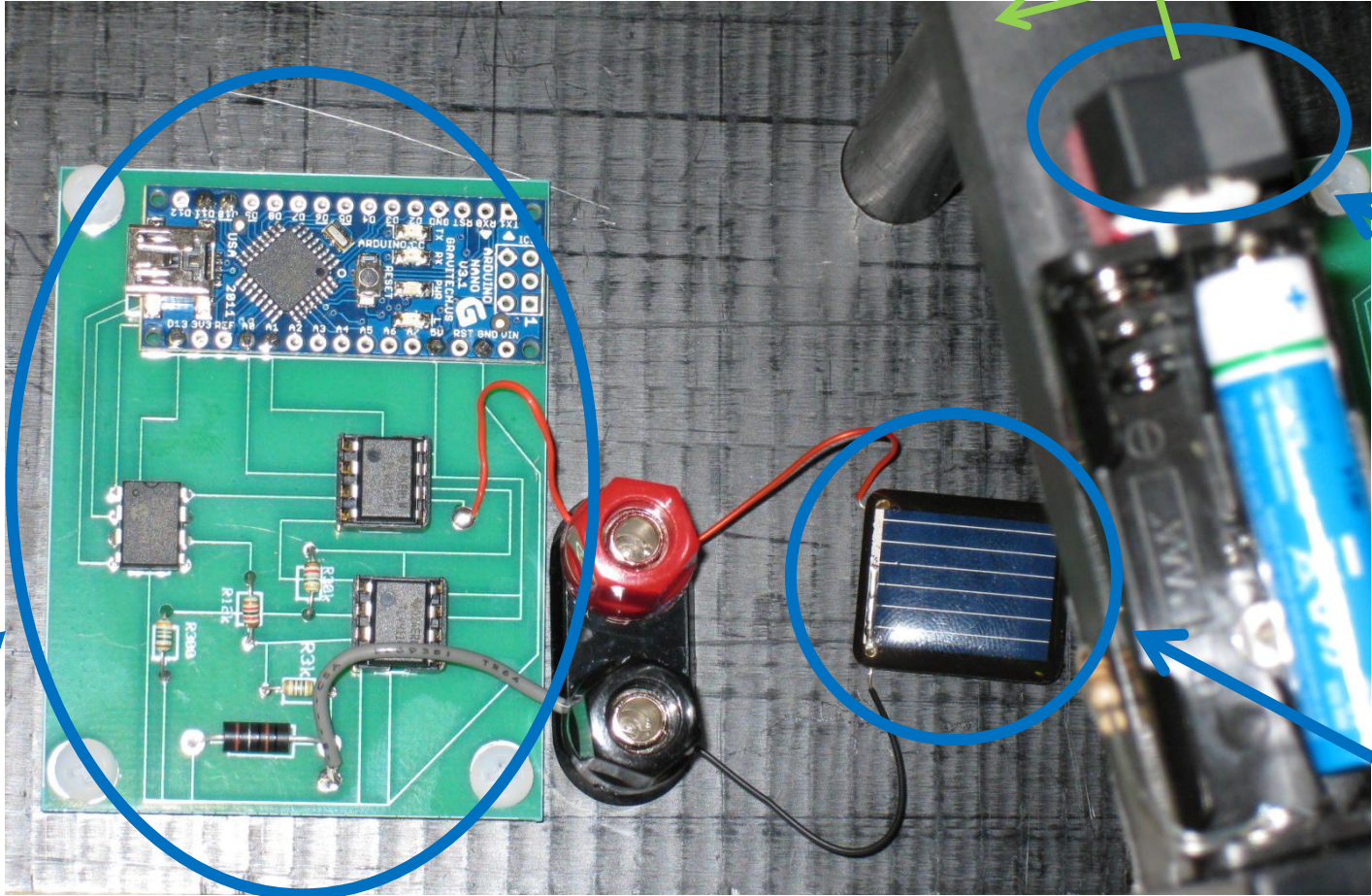

Printed Circuit Board

Light Switch

Solar Cell

Yellow OFF IR

Printed Circuit Board Layout

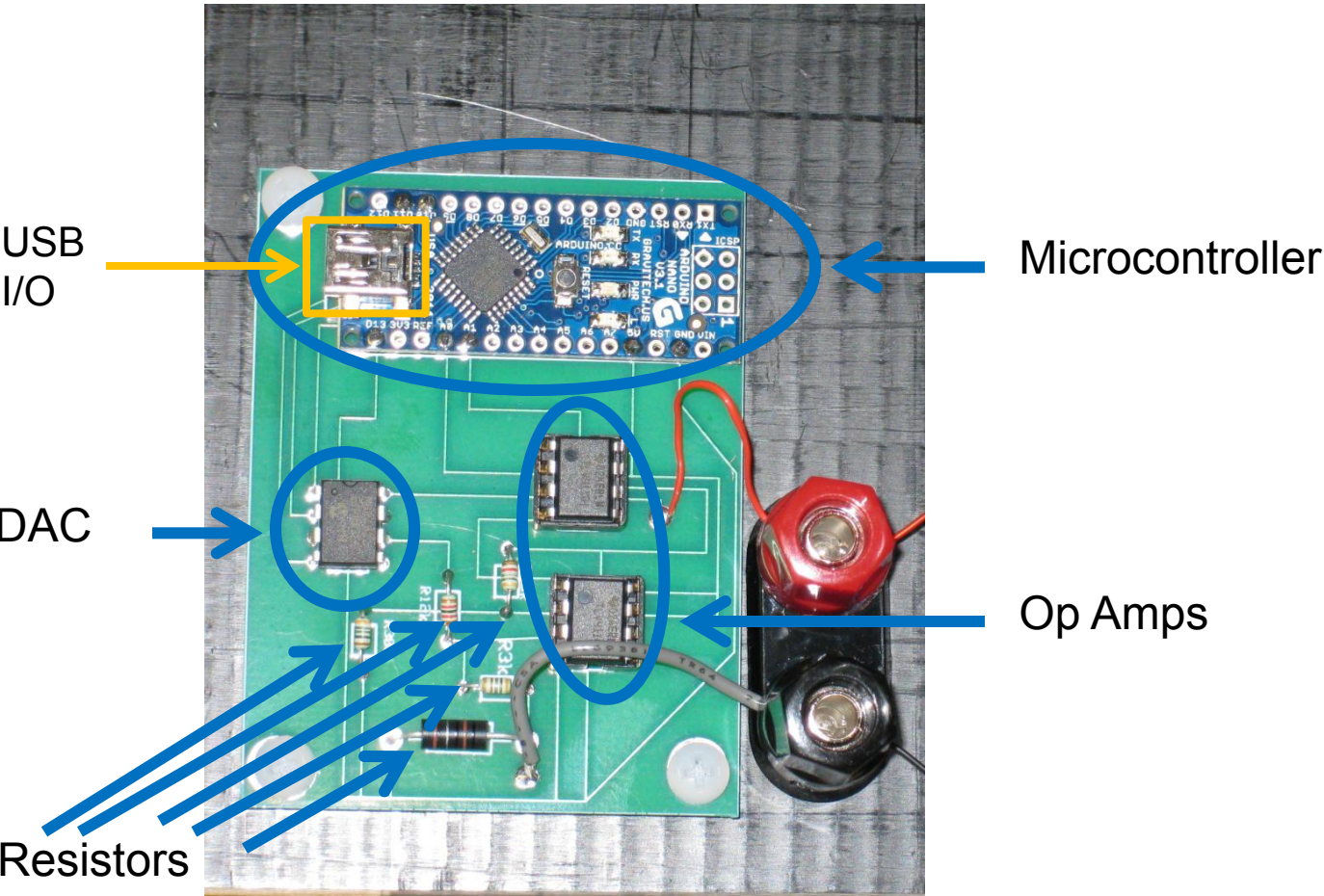

PCB Section 1a: Sweep Voltage – Program

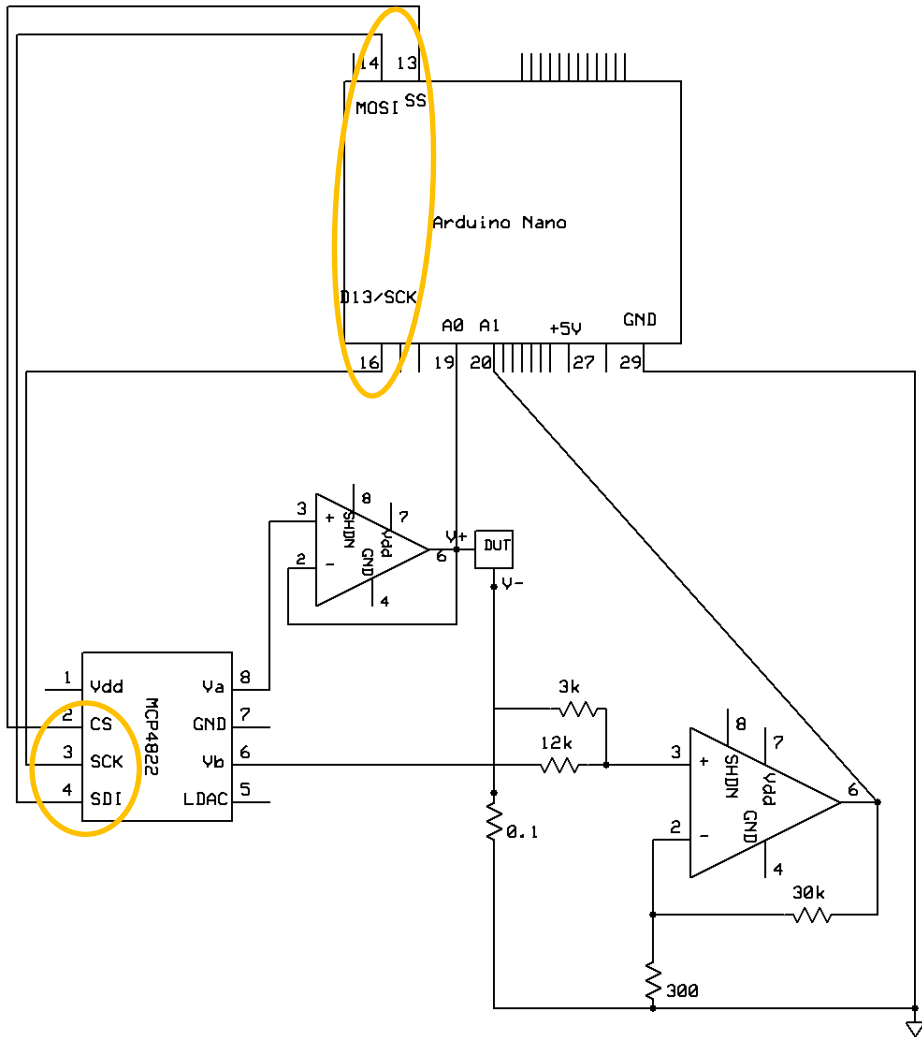
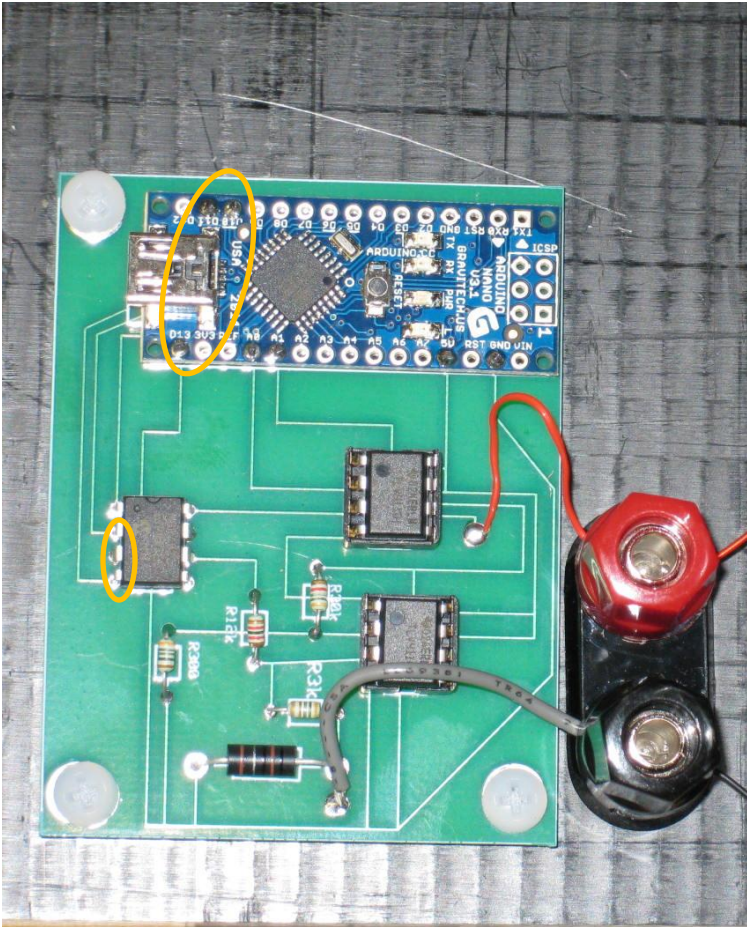

PCB Section 1b: Sweep Voltage – Sweep

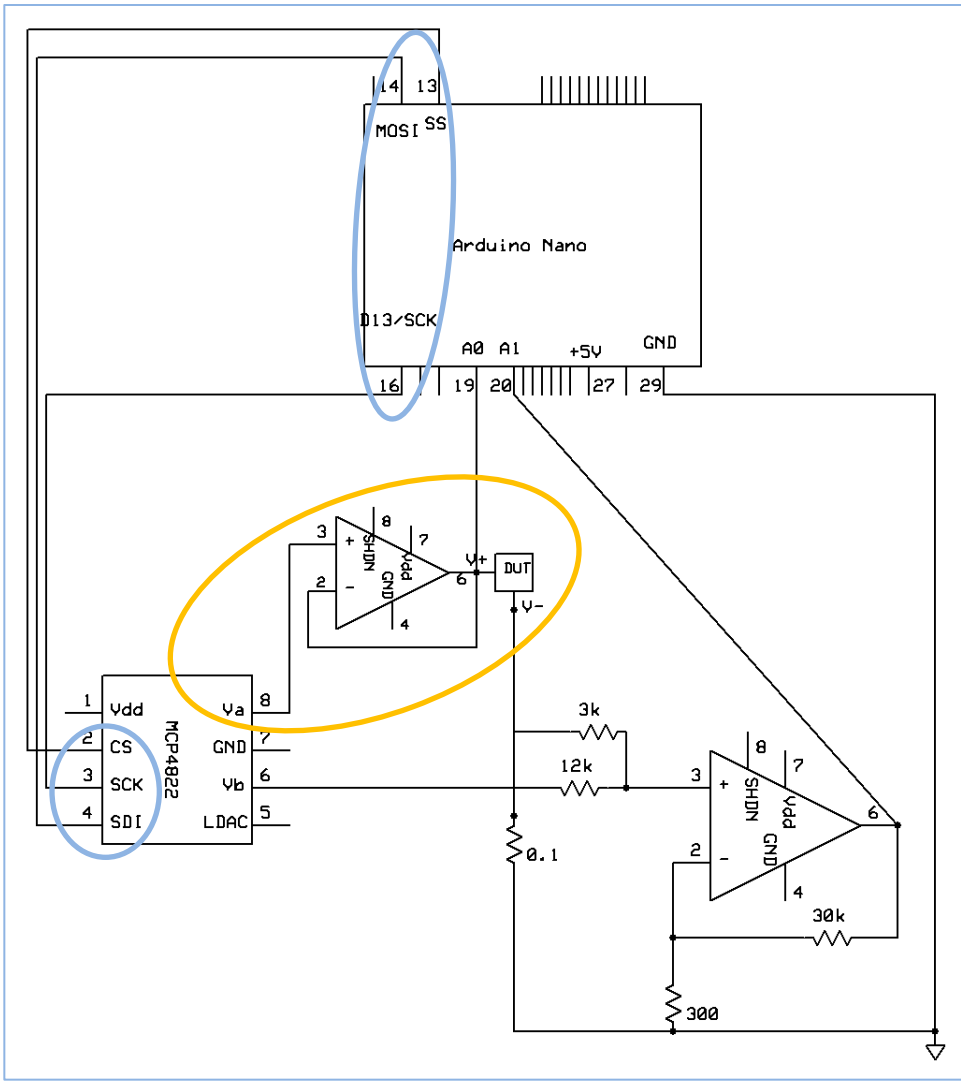
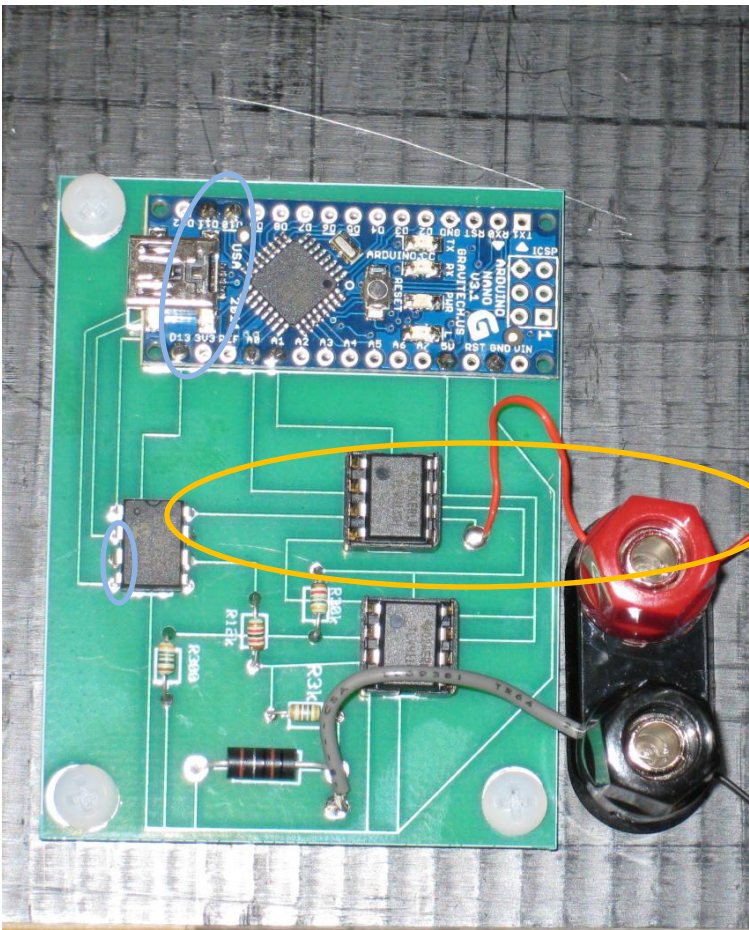

PCB Section 1c: Sweep Voltage – Read

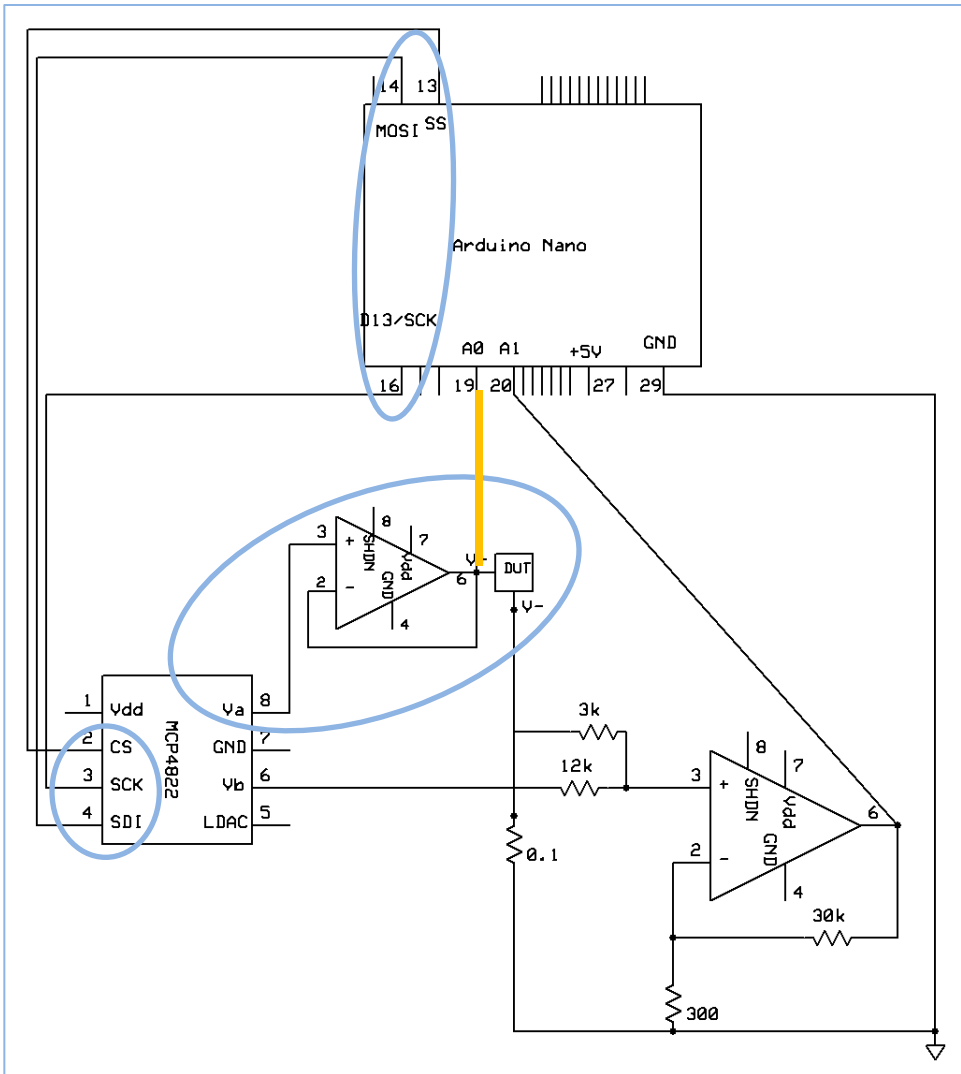
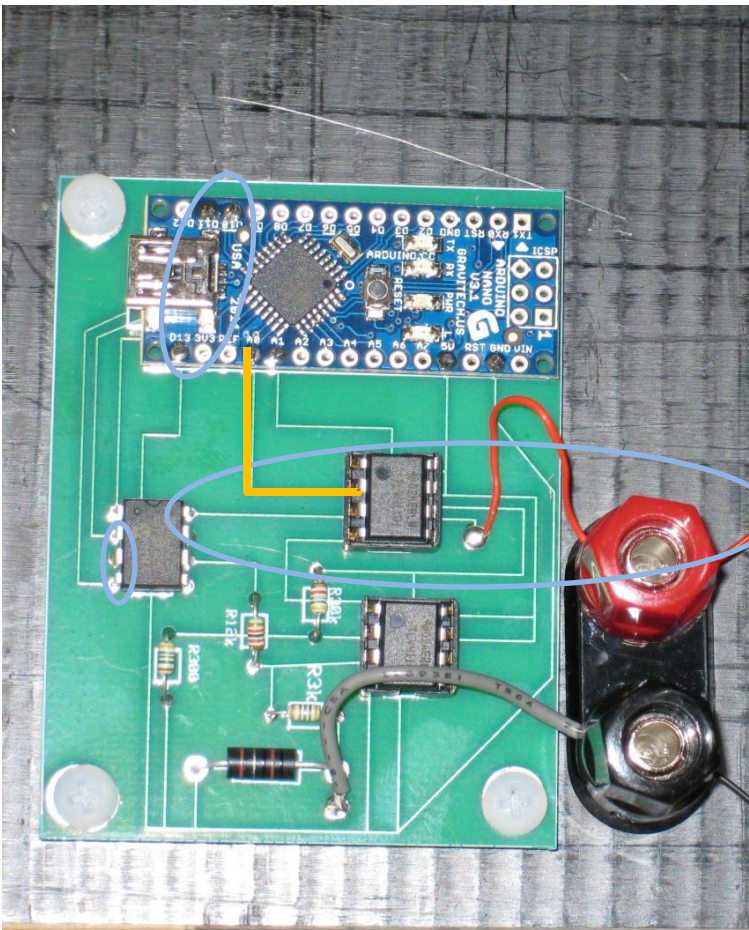

PCB Section 2a: Measure Current – Change to Voltage

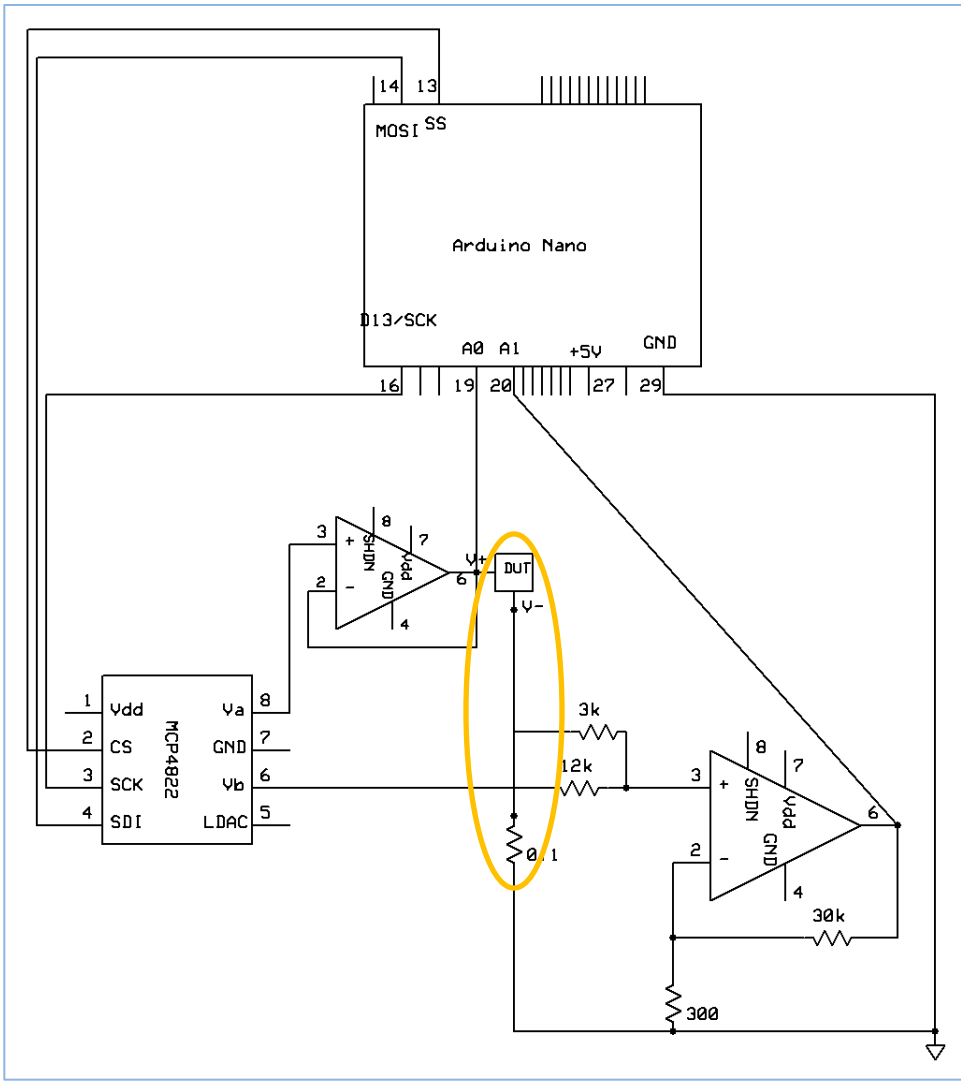
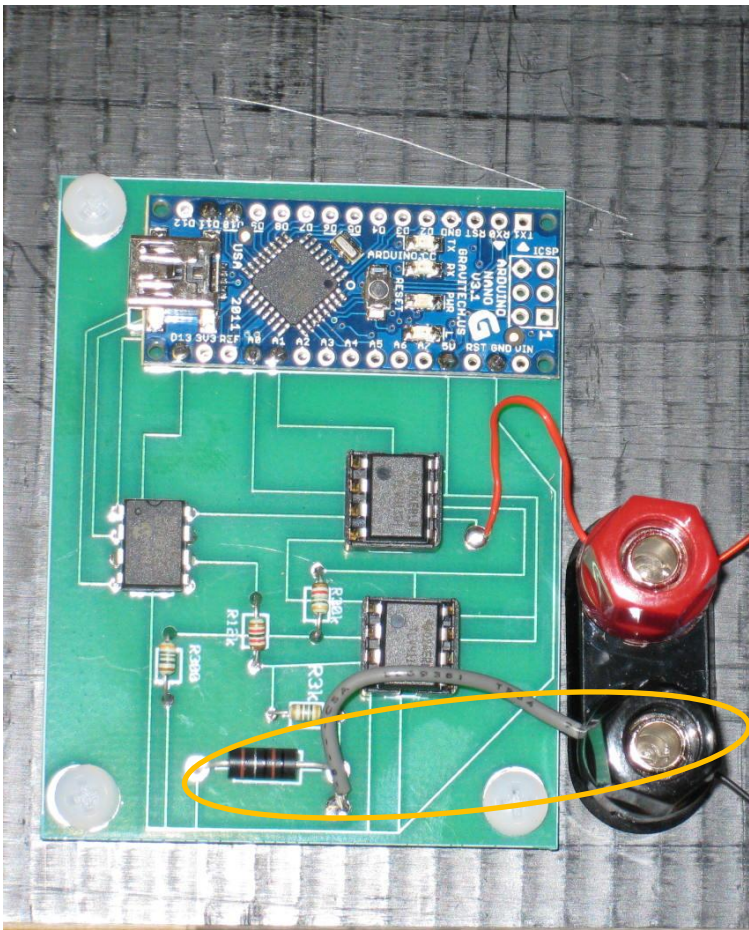

PCB Section 2a: Measure Current – Rescale 0 - 5V

- Summing Amplifier

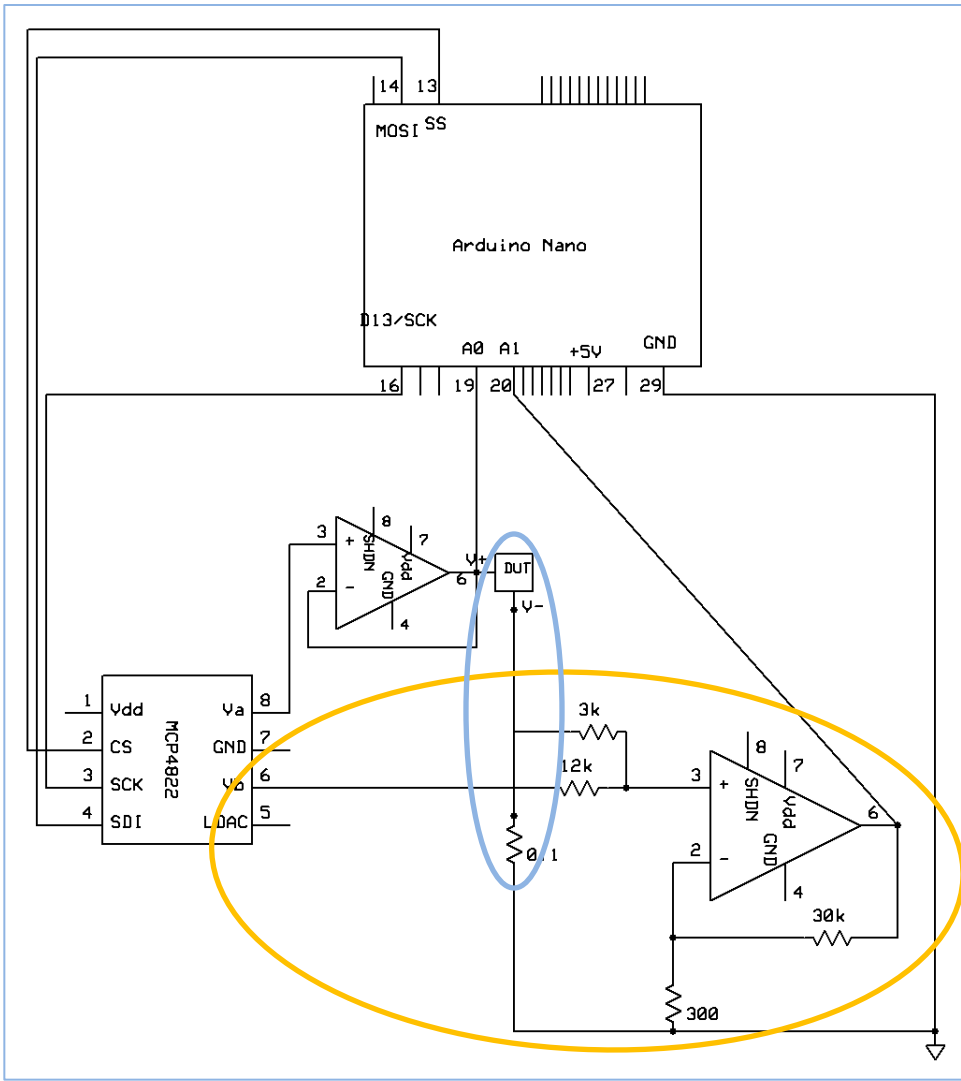
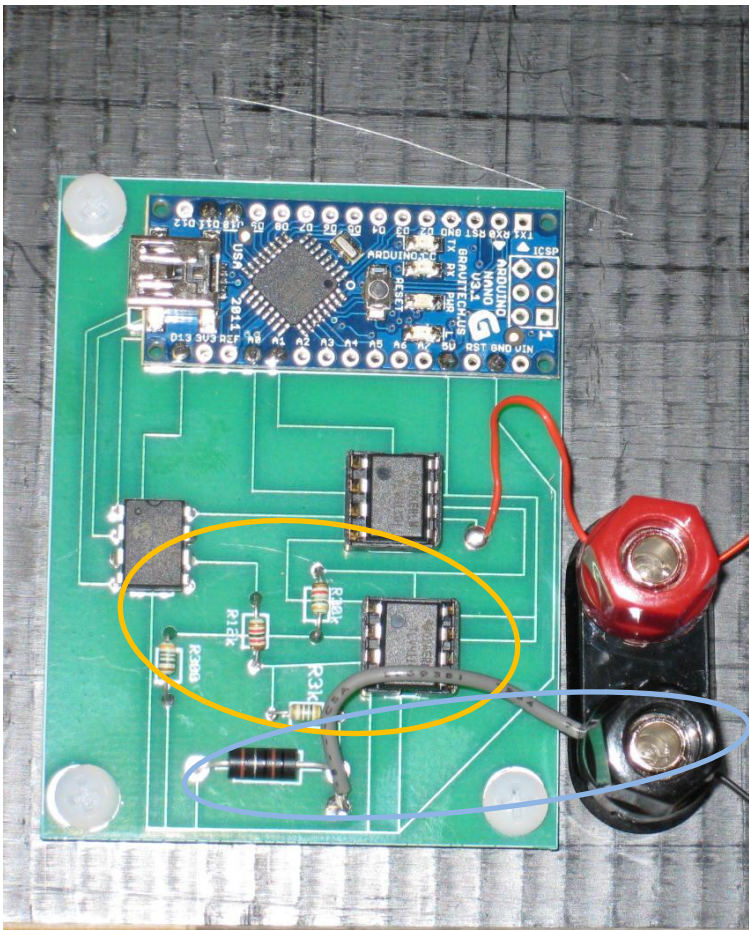

PCB Section 2a: Measure Current – Read Current

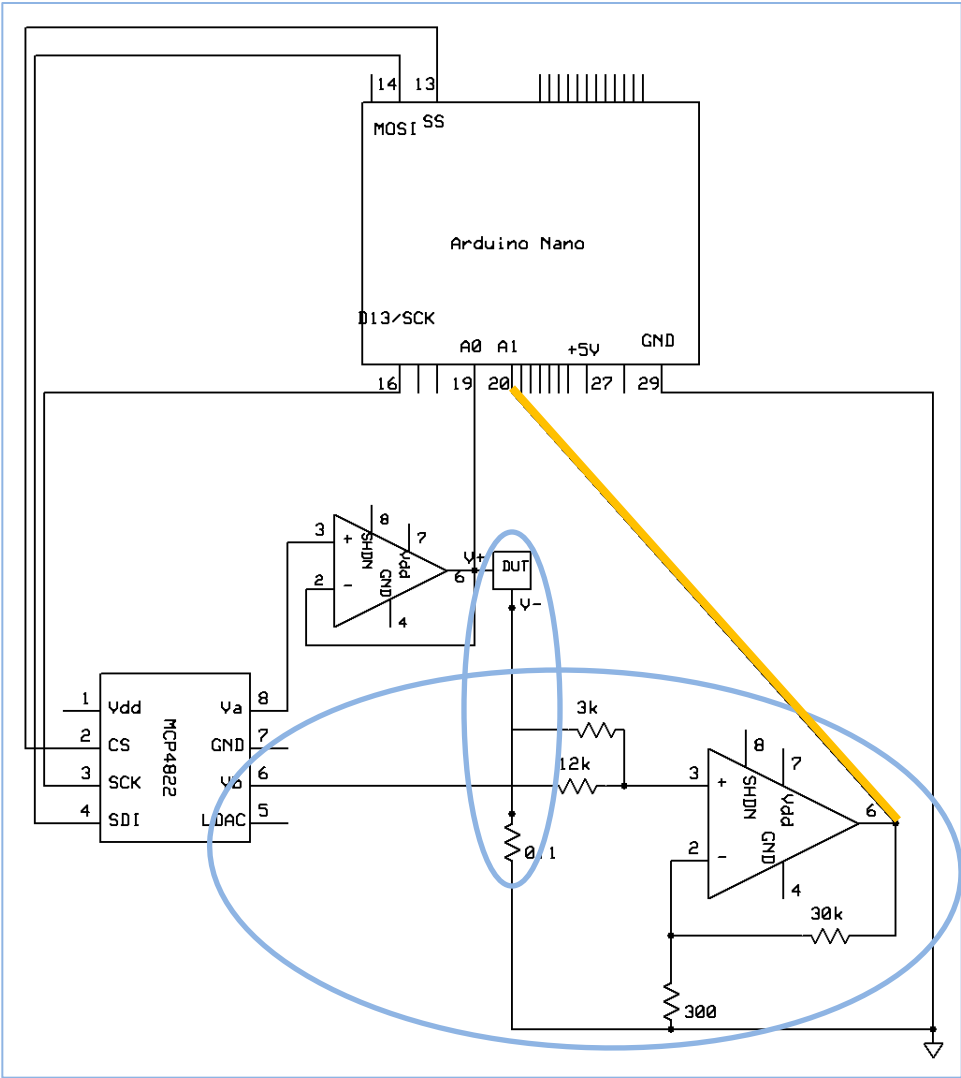
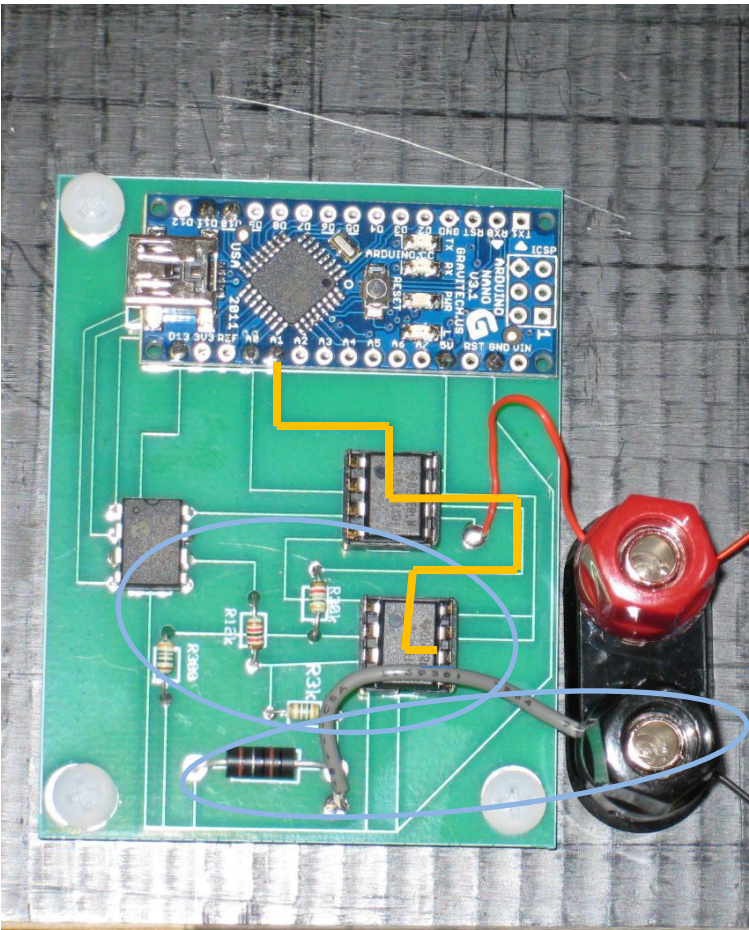

Learning Objectives: Illuminated Solar Cell

1. Diode in the Dark: Construct energy band diagram of pn -junction.
2. Diode under illumination: Construct energy band diagram. Denote drift, diffusion, and illumination currents.
3. In class exercise: Measure illuminated IV curves.
4. **Define parameters that determine solar cell efficiency:**
 - **Built-in voltage (V_{bi})**
 - **Bias voltage (V_{bias})**
 - **Open-circuit voltage (V_{oc})**
 - **Short-circuit current (J_{sc})**
 - **Saturation (leakage) current (J_o)**
 - **Maximum power point (MPP)**
 - **Fill factor (FF)**

How Solar Conversion Efficiency is Determined from an IV Curve

Terminology

- Often, PV researchers will report a “current density” (current per unit area, e.g., mA/cm²) in lieu of “total current”. Normalizing for geometry makes it easier to compare the performance of two or more devices of similar semiconductor materials but different sizes.
- The variable “ I ” is typically used to represent “current”, while the variable “ J ” represents “current density”. Thus, you may well see “ JV curves” reported in the literature.

Key Concept:

“Conversion efficiency” of a solar cell device can be determined by measuring the IV curve. Just three IV-curve parameters are needed to calculate conversion efficiency: Short-circuit current density (J_{sc} , the maximum current density of the device in short-circuit conditions), open-circuit voltage (V_{oc} , the maximum voltage produced by the device, when the two terminals are not connected), and fill factor (ratio of “maximum power” to the $J_{sc} * V_{oc}$ product).

Efficiency Calculations

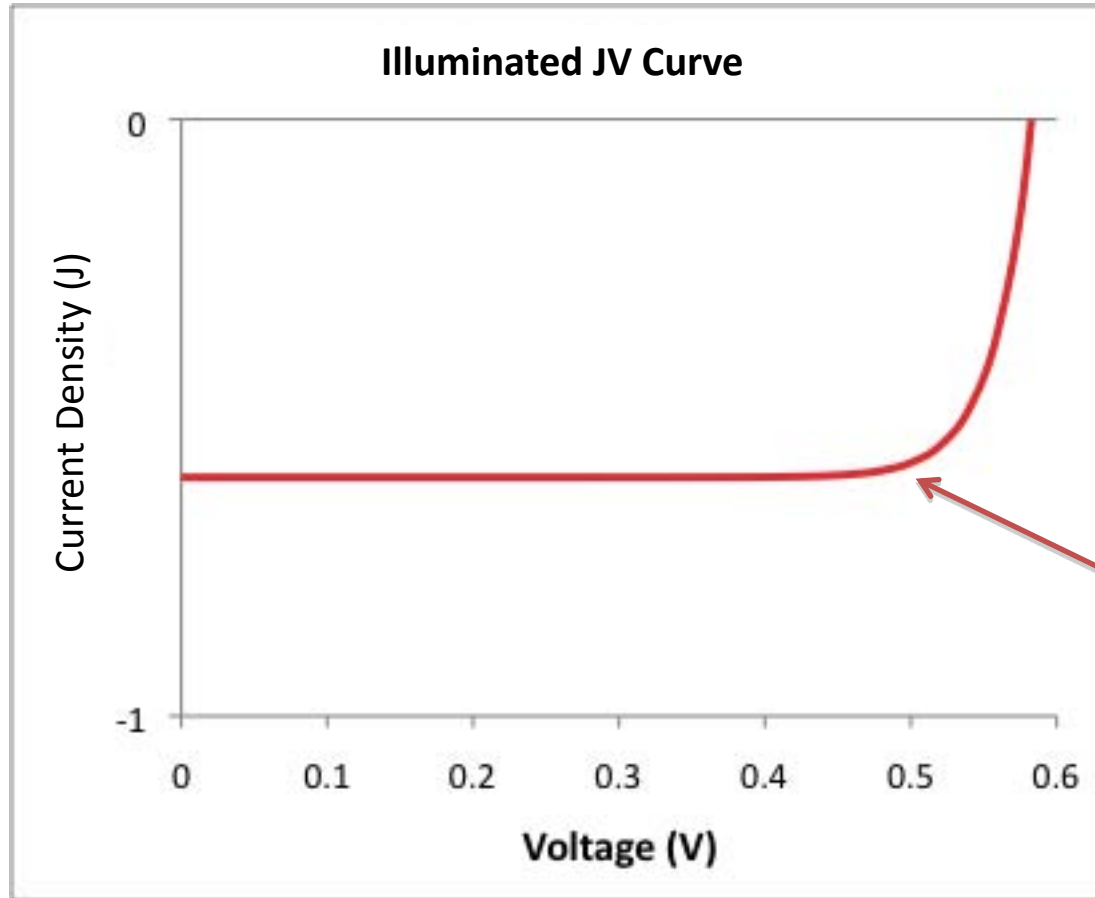

$$J = J_0 \left(e^{qV/kT} - 1 \right) - J_L$$

Efficiency Calculations

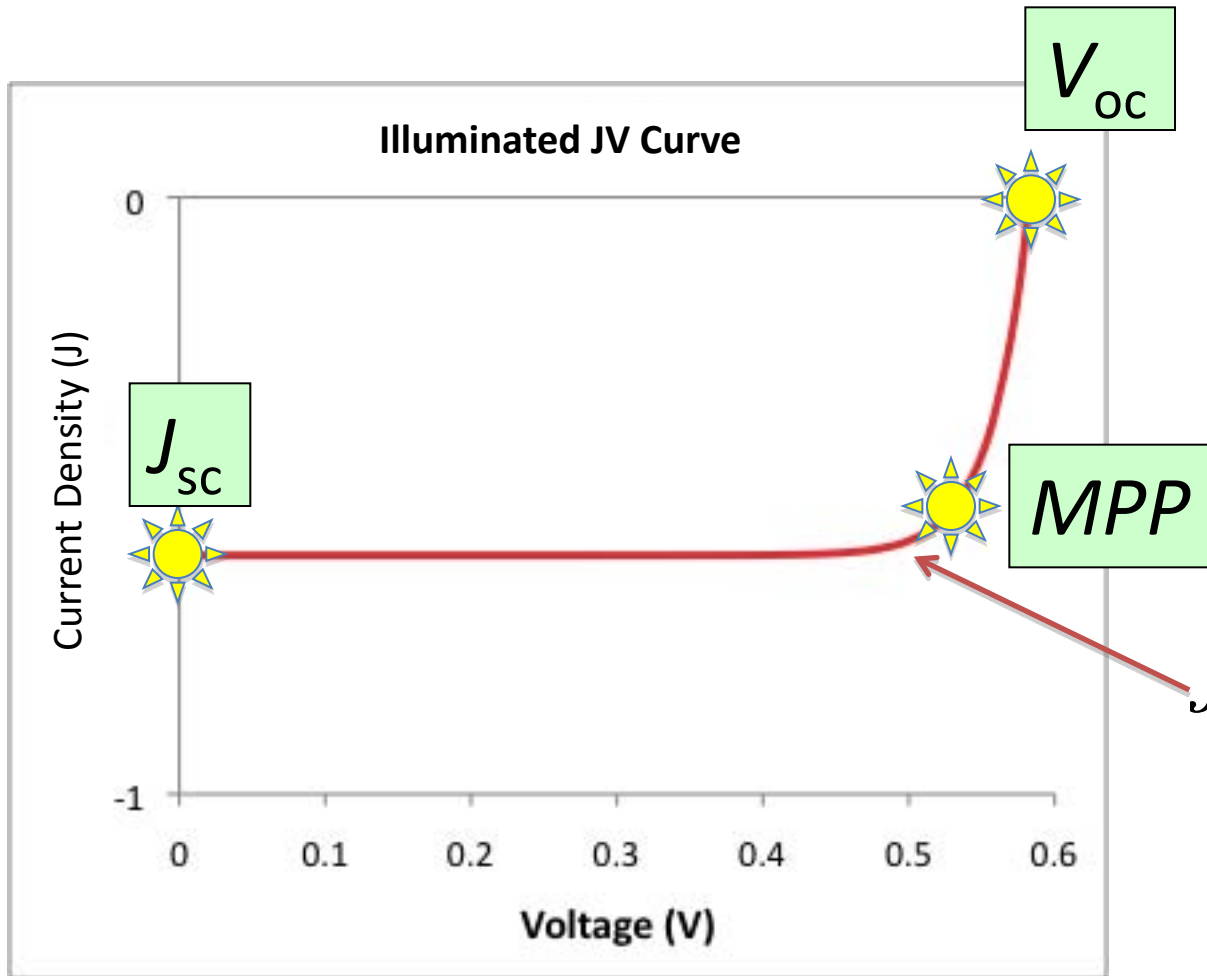

$$J = J_0 \left(e^{qV/kT} - 1 \right) - J_L$$

Efficiency Calculations

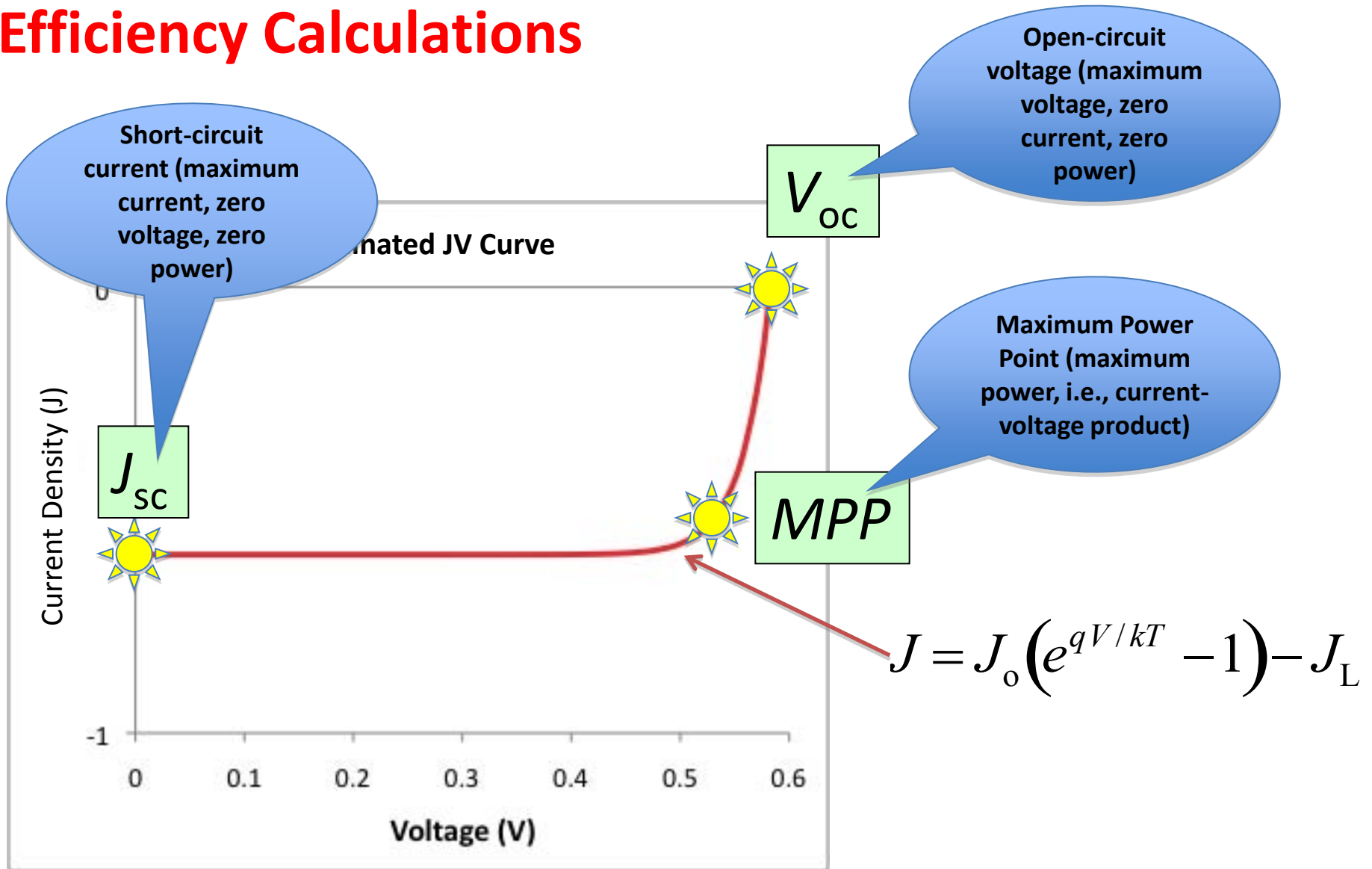

Efficiency Calculations

Industry Convention: Quadrant flipped!

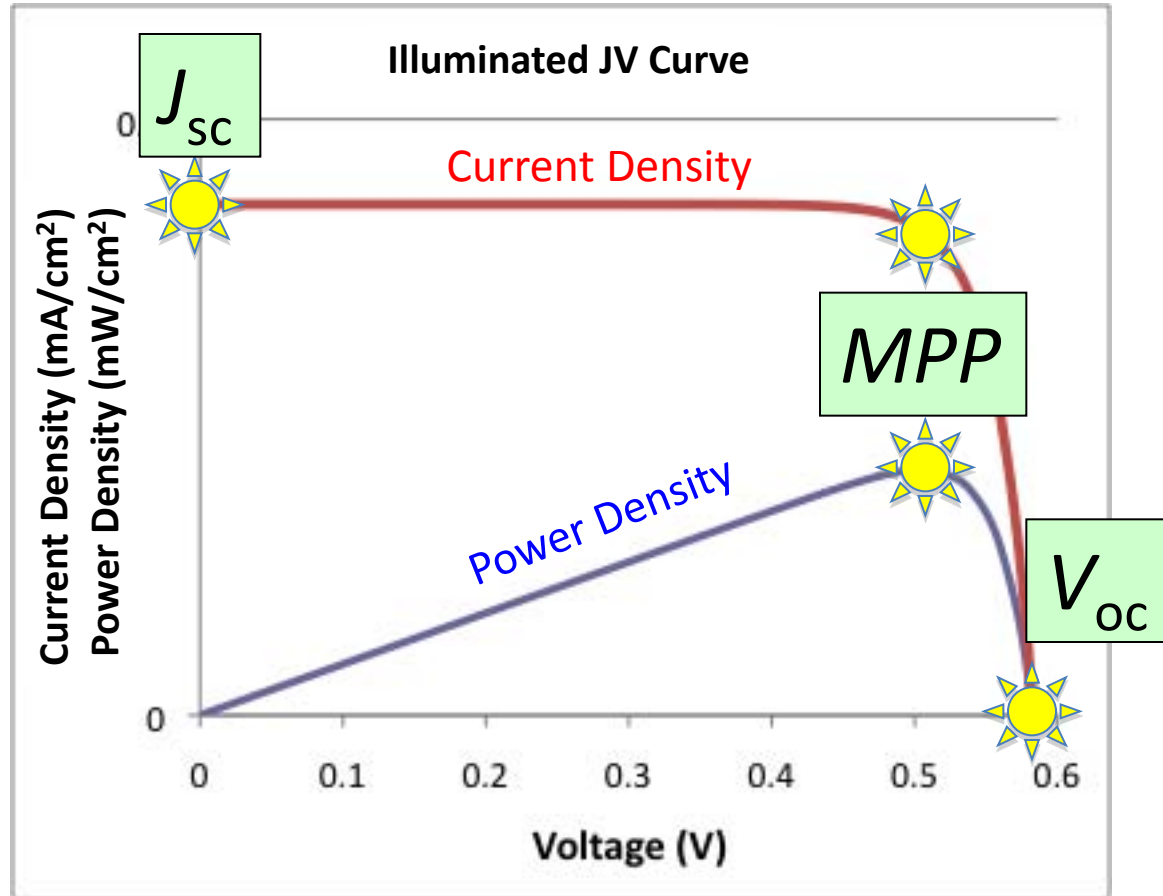

Efficiency Calculations

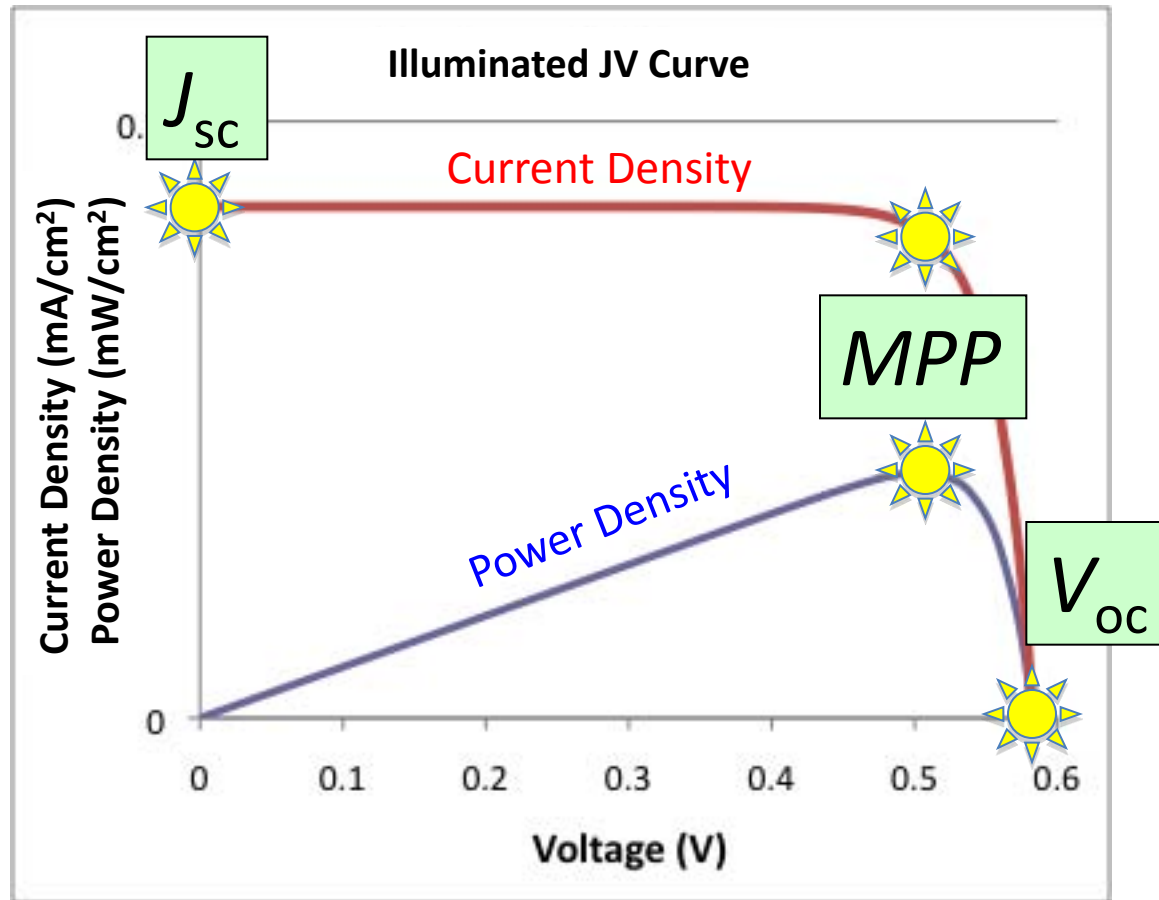

$$\text{Efficiency} \equiv \eta = \frac{\text{Power Out}}{\text{Power In}} = \frac{V_{mp} \cdot J_{mp}}{\Phi}$$

Efficiency Calculations

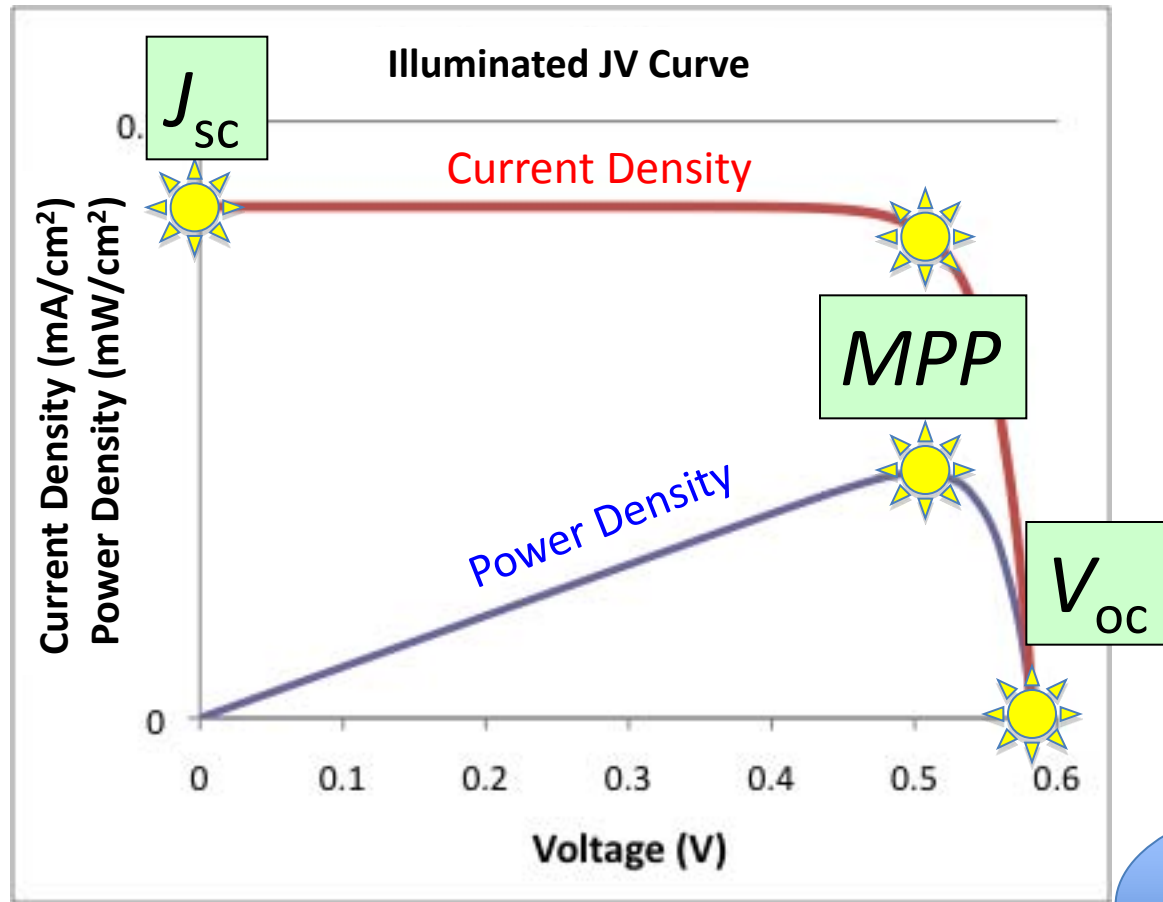

Solar Cell Output Power at MPP

Sunlight (Input)

$$\text{Efficiency} \equiv \eta = \frac{\text{Power Out}}{\text{Power In}} = \frac{V_{mp} \cdot J_{mp} \cdot A}{\Phi}$$

Efficiency Calculations

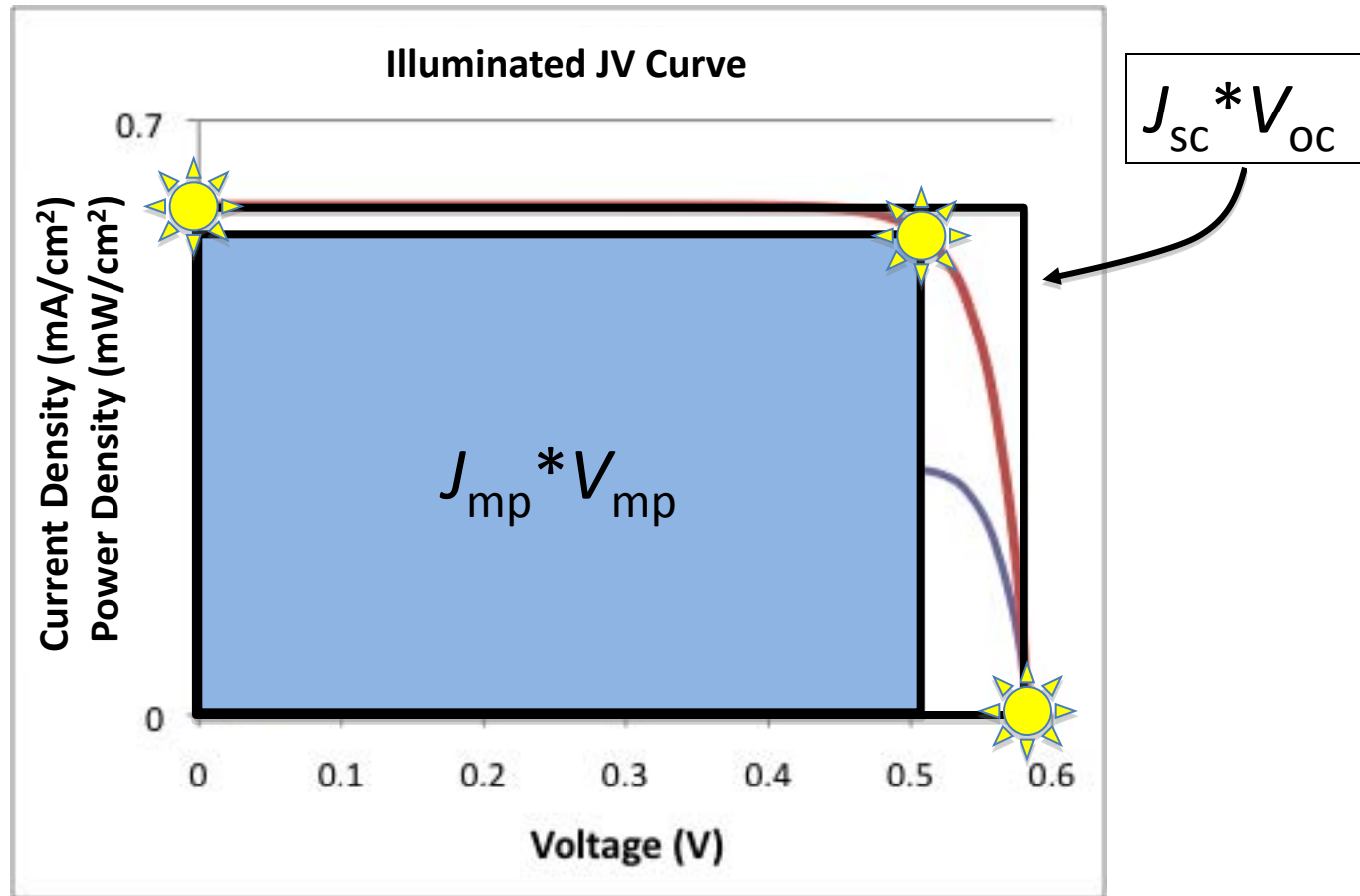

$$\text{Fill Factor} \equiv FF = \frac{V_{mp} \cdot J_{mp}}{V_{oc} \cdot J_{sc}}$$

Efficiency Calculations

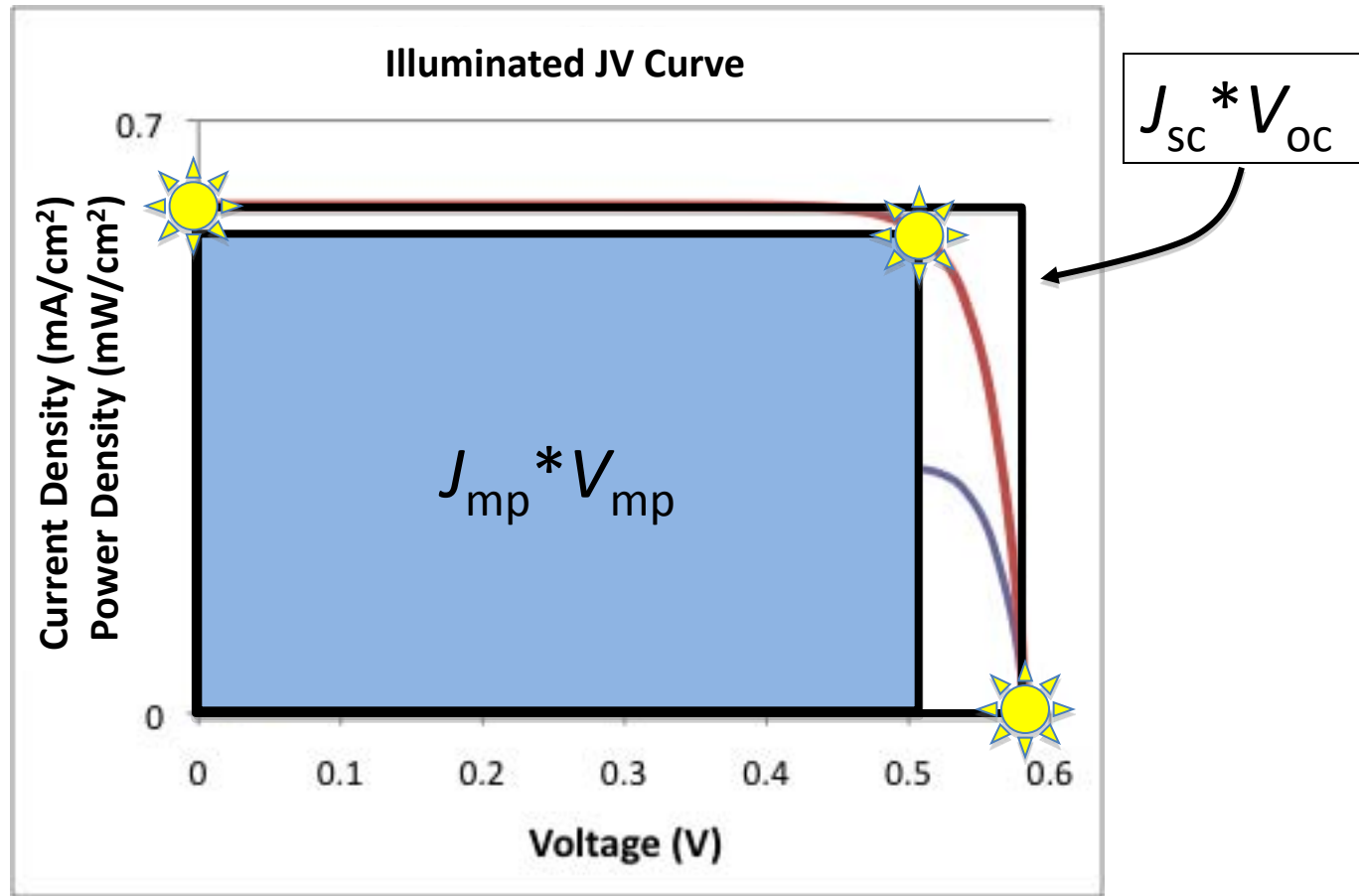

$$\text{Fill Factor} \equiv FF = \frac{V_{mp} \cdot J_{mp}}{V_{oc} \cdot J_{sc}}$$

Ratio of areas of two boxes, defined by $J_{sc} \times V_{oc}$, and $J_{mp} \times V_{mp}$.

Efficiency Calculations

By combining equations 1 and 2...

$$\text{Efficiency} \equiv \eta = \frac{\text{Power Out}}{\text{Power In}} = \frac{V_{\text{mp}} \cdot I_{\text{mp}}}{\Phi}$$

$$\text{Fill Factor} \equiv FF = \frac{V_{\text{mp}} \cdot I_{\text{mp}}}{V_{\text{oc}} \cdot I_{\text{sc}}} = \frac{V_{\text{mp}} \cdot J_{\text{mp}}}{V_{\text{oc}} \cdot J_{\text{sc}}}$$

We obtain:

$$\text{Efficiency} \equiv \eta = \frac{\text{Power Out}}{\text{Power In}} = \frac{V_{\text{mp}} \cdot I_{\text{mp}}}{\Phi} = \frac{FF \cdot V_{\text{oc}} \cdot I_{\text{sc}}}{\Phi}$$

Why does Efficiency matter?

Key Concept:

“Conversion efficiency” effectively determines the area of solar collectors needed to produce a given amount of power.

Since many costs scale with area (e.g., glass, encapsulants, labor, mounting, framing... pretty much everything but the inverter), increasing conversion efficiency is a highly leveraged way to reduce the cost of solar.

The Area Needed to Produce A Certain Amount of Power Scales with Efficiency

$$\eta = \frac{\text{generated electrical power}}{\text{incident light power}}$$

100% efficiency
(impossible to achieve)



33% efficiency
(space-grade solar cells)

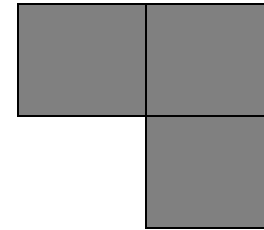

Very
Expensive
material

20% efficiency
(monocrystalline
silicon solar cells)

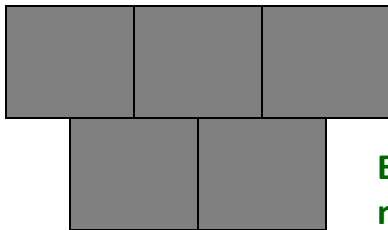

Expensive
material

10% efficiency
(thin film material)

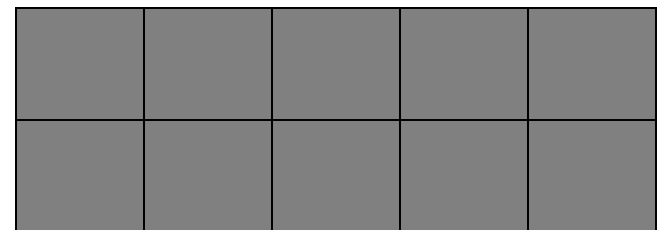

Relatively Inexpensive material

The Cost of Materials (Glass, Encapsulants...) Scales with the Area, i.e., Inversely with Efficiency

See: T. Surek, *Proc. 3rd World Conference on Photovoltaic Energy Conversion (WCPEC)*, Osaka, Japan (2003)

MIT OpenCourseWare
<http://ocw.mit.edu>

2.626 / 2.627 Fundamentals of Photovoltaics
Fall 2013

For information about citing these materials or our Terms of Use, visit: <http://ocw.mit.edu/terms>.